

LIST OF PARTS



MACHINES

Nos. 44-1 to 44-3, 44-8,
44-9, 44-13, 44-17, 44-20,
44-22 to 44-24, 44-28,
44-29, 44-72, 44-74
and 44-75

** A TRADE MARK OF

THE SINGER MANUFACTURING COMPANY

INSTRUCTIONS FOR OILING

To ensure easy running and prevent unnecessary wear of the parts which are in movable contact, the machine requires oiling and when in continuous use, "TYPE B" or "TYPE D" OIL, sold only by Singer Sewing Machine Company, should be applied at least twice each day to all oil holes marked "OIL".

"TYPE D" OIL is stainless.

COPYRIGHT, U. S. A.

1913, 1917, 1920, 1921 AND 1922

BY

THE SINGER MANUFACTURING COMPANY

ALL RIGHTS RESERVED FOR ALL COUNTRIES

INDEX

	PAGE
ATTACHMENTS AND ACCESSORIES.....	132
BELT GUARD.....	132
BINDERS.....	133
BOBBIN WINDERS.....	176
BOX PLAINTER PARTS.....	146
CORDERS.....	147
DRIVING ATTACHMENT No. 16531.....	181
" " " 24073.....	184
EDGE FOLDERS ON SHANK.....	149
FELLER.....	149
FINGER GUARD.....	149
FOOT LEVER PARTS.....	184
" LIFTER PARTS.....	184
GUIDES.....	154
HEMMERS.....	156
HEMSTITCHER.....	161
IRON BASE.....	131
KNEE LIFTER PARTS.....	186
KNIFE GRINDER.....	188
LAP SEAM FELLER.....	161
MACHINE No. 44-1.....	9
" " 44-2.....	17
" " 44-3.....	24
" " 44-8.....	31
" " 44-9.....	39
" " 44-13.....	47
" " 44-17.....	56
" " 44-20.....	64
" " 44-22.....	72
" " 44-23.....	79
" " 44-24.....	86
" " 44-28.....	93
" " 44-29.....	101
" " 44-72.....	109
" " 44-74.....	117
" " 44-75.....	124
NUMERICAL LIST OF PARTS.....	201
OBSOLETE PARTS.....	194
PIPING ATTACHMENTS.....	167
PRESSER FEET.....	161
QUILTERS.....	167
RUFFLERS.....	167
SEAMER.....	171

	PAGE
SEAMING GUIDE.....	175
SEPARATING BLADE (HINGED).....	171
SPOOL HOLDER (DISC).....	172
STAND No. 25265.....	189
“ “ 25279.....	190
“ “ 25284.....	191
STRIP FOLDER (FOOT).....	153
“ “ ON SHANK.....	153
“ FOLDERS.....	151
THREAD UNWINDERS.....	193
THROAT PLATES.....	172
TRIMMINGS FOR END AND BACK LEAF TABLE.....	192
TUBULAR TRIMMING ATTACHMENT.....	172
TUCKER.....	172
“ (LONG ARM).....	174
“ (POWER) NO. 26377.....	173
“ “ “ 26687.....	174
UNIVERSAL FELLING ATTACHMENTS.....	175
WELT GUIDE.....	176

INSTRUCTIONS FOR ORDERING

In ordering from this list, use **ONLY** the **PART** number in the **FIRST** column.

The number stamped on a Sewing Machine part is in **every case** the number of the single part only.

Every combination of parts sent out as such has its specific number, which, although not stamped on the parts, must be used when ordering the combination.

Each number always indicates the **SAME PART** in whatever list it appears, or for whatever machine.

The letters after some of the numbers indicate the **style** of finish only, as follows:

- A. Hardened, Polished and Plated.
- B. Polished and Plated.
- C. Hardened only.
- D. Polished only.
- E. Soft, not Polished.
- F. Hardened and Polished.
- G.
- H. Blued.
- J. Plated only.
- K. Hardened and Plated.
- L. Brass or Gilt
- M. Oxidized.
- P. Japanned.
- R. Parkerized.

These letters **MUST BE USED** when they appear in the list, and **AFTER** the number as in the list.

In this series

- 1 to 1500 and 50001 to 51500 are Screw Numbers.
- 1501 to 1800 are Nut Numbers.
- 1801 to 2000 are Roller Numbers.
- 2001 to 50000 and 52001 and upward are numbers of Machine Parts.

The figures in the second column refer only to the plates illustrating the parts, and are **NOT TO BE USED** in ordering

Parts marked with an asterisk (*) are furnished only when repairs are made at factory.

**LIST OF PARTS COMPLETE
FOR
MACHINE No. 44-1
DROP FEED, FOR GENERAL CLOTH WORK**

NO.	PLATE	NAME
*16501	—	Arm with 11104.....
8582	773	" Dowel Pin.....
12453	773	" Oil Tube for intermediate bearing. . .
12454	773	" " " " with 29599, for oiling 12409
11119	773	" " " " " " " 12408
24131	2014	" " " " " " " 20283
29599	2014	" " " Packing (felt).....
748E	782	" Screw (back).....
868E	1366	" " (front).....
16511	1349	" Shaft.....
*11104	—	" " Bushing (front).....
12357	767	" " Flanged Bushing (back).....
448c	783	" " " " " " Set Screw.....
144D	782	Arm Shaft Screw.....
12480	767	" Side Cap.....
219D	774	" " " Screw.....
12193	2004	" " Cover.....
286D	783	" " " Thumb Screw.....
12403	772	" Spool Pin and Thread Eyelet.....
11241	2003	" " " Washer (cloth).....
24296	1348	Balance Wheel (power) light rim, 2 $\frac{3}{16}$ in. pulley, with two 448c.....
24297	1340	Balance Wheel Oil Cover.....
210D	1343	" " " " Screw.....
448c	783	" " Set Screw.....
*16503	—	Bed.....
20197	1350	Crank Connecting Rod with 20198 and two 896E.....
*20198	—	Crank Connecting Rod Cap.....
896E	773	" " " " Screw.....
908c	773	" " " Hinge Screw.....
1619E	773	" " " " " Nut.....
20057	—	Face Plate.....
20058	1340	Face Plate complete, Nos. 2827, 12150 and 20057.....

from the library of: David and Lucile Packard Foundation

NO.	PLATE	NAME
190D	782	Face Plate Screw.....
44181	—	“ “ Thread Guard (lower).....
12150	773	“ “ “ “ “ 44181 with 12152.....
12152	773	Face Plate Thread Guard (lower) Rivet... ..
2827	773	“ “ “ “ (upper) with 8505.....
8505	773	“ “ “ “ “ Rivet... ..
286D	783	“ “ Thumb Screw.....
12368	767	Feed Bar.....
313c	783	“ “ Screw Centre.....
56813	—	“ “ “ “ 313c with 1519J... ..
1519J	783	“ “ “ “ Nut.....
3033	770	“ Connecting Link.....
375c	782	“ “ “ Hinge Screw.....
1518E	783	“ “ “ “ “ Nut.....
12369	776	Feed Dog, 12 teeth (12 teeth to the inch)
NOTE: No. 12369 is sent with this Machine unless another Feed Dog is specified on order.		
12457	776	Feed Dog, for cloth, 16 teeth (16 teeth to the inch).....
12370	778	Feed Dog, for cloth, 15 teeth (16 teeth to the inch).....
43979	778	Feed Dog, for cloth, 21 teeth (22 teeth to the inch).....
12425	779	Feed Dog, for cloth.....
12450	777	“ “ “ “ 11 teeth (18 teeth to the inch).....
20348	777	Feed Dog, for chiffon, 22 teeth (36 teeth to the inch).....
20275	1259	Feed Dog, for umbrella work.....
19474	1258	“ “ “ corset work.....
44136	5805	“ “ “ tailor work.....
20018	1258	“ “ “ finishing knit underwear... ..
20119	1259	“ “ “ heavy work on duck, overalls, etc.....
20352	1267	Feed Dog for general muslin work.....
208E	782	“ “ Screw.....
20283	1315	“ and Feed Lifting Eccentric with 446c.....
446c	783	“ “ “ “ “ Set Screw.....
24036	1340	“ “ “ “ “ Sleeve... ..
20284	1350	“ Forked Connection.....
375c	782	“ “ “ Hinge Screw... ..
1518E	783	“ “ “ “ “ Nut.....
24969	2551	“ Lifting Rock Shaft.....
24970	—	Feed Lifting Rock Shaft complete, Nos. 12376 and 24969.....

NO.	PLATE	NAME
12376	770	Feed Lifting Rock Shaft Crank with 157J and 1813.....
157J	782	Feed Lifting Rock Shaft Crank Clamping Screw.....
1813	783	Feed Lifting Rock Shaft Crank Roller and Stud.....
43976	2551	Feed Lifting Rock Shaft Crank Connecting Rod with 43977 and two 966E.....
*43977	—	Feed Lifting Rock Shaft Crank Connecting Rod Cap.....
966E	5806	Feed Lifting Rock Shaft Crank Connecting Rod Cap Screw.....
375c	782	Feed Lifting Rock Shaft Crank Connecting Rod Hinge Screw.....
1518E	783	Feed Lifting Rock Shaft Crank Connecting Rod Hinge Screw Nut.....
307c	783	Feed Lifting Rock Shaft Screw Centre... ..
56814	—	“ “ “ “ “ “ 307c with 1513J.....
1513J	783	Feed Lifting Rock Shaft Screw Centre Nut.....
3039	768	“ Regulator.....
1128E	2009	“ “ Hinge Screw.....
818D	783	“ “ Thumb Screw.....
16506	766	“ Rock Shaft.....
24376	—	Feed Rock Shaft complete, Nos. 16506 and 29633.....
29633	1354	Feed Rock Shaft Crank with 157J.....
157J	782	“ “ “ “ Clamping Screw.....
307c	783	“ “ “ Screw Centre.....
56814	—	“ “ “ “ “ 307c with 1513J.....
1513J	783	Feed Rock Shaft Screw Centre Nut.....
12381	767	Needle Bar (hollow).....
19229	2004	“ “ “ for high lift.....
12382	770	“ “ Connecting Link with 794E... ..
794E	782	“ “ “ “ Adjusting Screw.....
12383	—	Needle Bar Connecting Stud.....
1904	770	“ “ “ “ Roller (roller only).....
453c	783	Needle Bar Connecting Stud Set Screw... ..
12384	770	Needle Bar Connecting Stud complete, Nos. 453c, 1904 and 12383.....

NO.	PLATE	NAME
20188	767	Needle Bar Crank with 858c and 1065c..
1065c	1366	“ “ “ Position Screw.....
858c	783	“ “ “ Set Screw.....
936E	773	“ “ Screw Bushing.....
4302	773	“ “ Thread Guard.....
233D	782	“ “ “ “ Screw.....
4303	773	“ Clamp with 808F, for 12381.....
24101	—	“ “ Body.....
808F	782	“ “ Screw.....
24102	1353	“ “ Thread Guide.....
651D	1353	“ “ “ “ Screw.....
24103	1353	Needle Clamp (high lift) complete for 19229, Nos. 651D, 808F, 24101 and 24102
24104	1350	Oscillating Rock Shaft.....
24105	—	Oscillating Rock Shaft complete, Nos. 4784, 12388 and 24104.....
12388	767	Oscillating Rock Shaft Hinge Pin.....
878J	783	“ “ “ “ Oil Hole Stop Screw.....
12459	773	Oscillating Rock Shaft Hinge Pin Oil Hole Stop Screw Washer (leather).....
448c	783	Oscillating Rock Shaft Hinge Pin Set Screw.....
4784	1353	Oscillating Rock Shaft Oil Pad.....
16509	766	“ Shaft.....
19496	—	“ “ Crank for 19447.....
44134	—	“ “ “ “ 44135.....
19447	1353	Oscillating Shaft Crank complete, Nos. 457c, 1518E, 19449 and 19496.....
44135	5806	Oscillating Shaft Crank complete, Nos. 1518E, 19449, 44134 and two 453c.....
2049	773	Oscillating Shaft Crank Pin.....
457c	783	“ “ “ Set Screw for 19447
453c	783	“ “ “ “ “ “ 44135
19448	1353	“ “ “ Slide Block.....
229D	782	“ “ “ “ “ Cap Screw.....
12424	773	Oscillating Shaft Crank Slide Block Cap Screw Washer.....
988c	1353	Oscillating Shaft Crank Slide Block Screw Stud.....
1518E	783	Oscillating Shaft Crank Slide Block Screw Stud Nut.....
19449	1353	Oscillating Shaft Crank Slide Block com- plete, Nos. 229D, 988c, 12424 and 19448

NO.	PLATE	NAME
12391	767	Presser Bar (hollow).....
20059	1341	“ “ Guide Bracket with 453c.....
453c	783	“ “ “ “ Set Screw.....
2062	771	“ “ Lifter.....
689c	782	“ “ “ Screw.....
1520E	783	“ “ “ “ Nut.....
12327	770	“ “ Lifting and Releasing Lever Bracket.....
11167	767	Presser Bar Spring (light) .051 wire.....
NOTE: No. 11167 is sent with this Machine unless another Spring is specified on order.		
12139	2004	Presser Bar Spring (medium) .055 wire...
20023	2004	“ “ “ (heavy) .063 wire.....
11170	771	“ “ “ Washer.....
12143	780	Presser Foot for 12369 and 12457.....
NOTE: No. 12143 is sent with this Machine unless another Presser Foot is specified on order.		
20458	780	Presser Foot for 44136.....
12335	1308	“ “ (narrow) for 12369 and 12457
12258	1308	“ “ (wide) for 12369 and 12457
12142	780	“ “ for 12370 and 43979.....
12259	780	“ “ “ 12425 and 19474.....
12260	780	“ “ “ 12450 and 20348.....
20020	1308	“ “ “ 20018.....
62527	5806	“ “ Hinge Pin.....
24544	—	“ “ Plate.....
24982	—	“ “ Shank.....
26231	2014	“ “ Spring.....
24983	781	Presser Foot (spring hinged) complete for 12425, 19474 and 20119, Nos. 24544, 24982, 26231 and 62527.....
7298	2014	Presser Foot Hinge Pin.....
19334	—	“ “ Plate.....
19335	—	“ “ Shank.....
19336	1308	Presser Foot (hinged) complete for 12370 and 20009, Nos. 7298, 19334 and 19335
7298	2014	Presser Foot Hinge Pin.....
20268	—	“ “ Plate.....
20269	—	“ “ Shank.....
20270	1308	Presser Foot (hinged) complete for 12369 and 12457, Nos. 7298, 20268 and 20269
20276	1259	Presser Foot for 20275.....
20342	781	“ “ “ 12450 and 20348.....
20343	781	“ “ “ with guide on bottom to the right of needle hole.....
190D	782	Presser Foot Screw.....

NO.	PLATE	NAME
19475	1258	Throat Plate, large needle hole, for 19474
44137	5895	" " " " " " 44136
44138	—	" " small needle hole, for 44136
20019	1258	" " large needle hole, for 20018
20120	1259	" " oblong needle hole, for 20119.....
20187	—	Throat Plate, small oblong needle hole, for 20119.....
20277	1259	Throat Plate, large needle hole, for 20275
20362	—	" " small needle hole, for 20275
20353	1267	" " large needle hole, for 20352
20354	—	" " small needle hole, for 20352
691F	782	" " Screw.....
24079	2644	Drip Pan with four 1 inch wire nails.....

LIST OF PARTS COMPLETE

FOR

MACHINE No. 44-2

DROP FEED, FOR SHIRTS, LINEN AND COTTON GOODS

NO.	PLATE	NAME
*16501	—	Arm with 11104.....
8582	773	" Dowel Pin.....
12453	773	" Oil Tube for intermediate bearing... ..
12454	773	" " " with 29599, for oiling 12409
11119	773	" " " " " " " " 12408
24131	2014	" " " " " " " " 20283
29599	2014	" " " Packing (felt).....
748E	782	" Screw (back).....
868E	1366	" " (front).....
16511	1349	" Shaft.....
*11104	—	" " Bushing (front).....
12357	767	" " Flanged Bushing (back).....
448c	783	" " " " " " Set Screw.....
144D	782	Arm Shaft Screw.....
12480	767	" Side Cap.....
219D	774	" " " Screw.....
12193	2004	" " Cover.....
286D	783	" " " Thumb Screw.....
12403	772	" Spool Pin and Thread Eyelet.....
11241	2003	" " " Washer (cloth).....
24296	1348	Balance Wheel (power) light rim, 2 $\frac{3}{16}$ in. pulley, with two 448c.....
24297	1340	Balance Wheel Oil Cover.....
210D	1343	" " " " Screw.....
448c	783	" " " Set Screw.....
*16503	—	Bed.....
20197	1350	Crank Connecting Rod with 20198 and two 896E.....
*20198	—	Crank Connecting Rod Cap.....
896E	773	" " " " Screw.....
908c	773	" " " " Hinge Screw.....
1619E	773	" " " " " Nut.....
20057	—	Face Plate.....
20058	1340	Face Plate complete, Nos. 2827, 12150 and 20057.....

NO.	PLATE	NAME
190D	782	Face Plate Screw
44181	—	“ “ Thread Guard (lower)
12150	773	“ “ “ “ “ “ 44181 with 12152
12152	773	Face Plate Thread Guard (lower) Rivet
2827	773	“ “ “ “ (upper) with 8505
8505	773	Face Plate Thread Guard (upper) Rivet
286D	783	“ “ Thumb Screw
12368	767	Feed Bar
313C	783	“ “ Screw Centre
56813	—	“ “ “ “ 313C with 1519J
1519J	783	“ “ “ “ Nut
3033	770	“ Connecting Link
375C	782	“ “ “ “ Hinge Screw
1518E	783	“ “ “ “ “ Nut
20336	1264	Feed Dog, for shirt work, beveled for hemmer
NOTE: No. 20336 is sent with this Machine unless another Feed Dog is specified on order.		
12468	777	Feed Dog, 16 teeth (16 teeth to the inch) for shirt work, beveled for hemmer
20471	777	Feed Dog, 22 teeth (22 teeth to the inch) for shirt work, beveled for hemmer
12481	778	Feed Dog, 18 teeth (16 teeth to the inch)
43978	778	“ “ 24 teeth (22 teeth to the inch) beveled for hemmer
12455	779	Feed Dog, for shirt work, beveled for hemmer
12372	778	Feed Dog, 13 teeth (12 teeth to the inch) beveled for hemmer
20002	778	Feed Dog, 18 teeth (16 teeth to the inch) beveled for hemmer
12437	777	Feed Dog, for cloth, four teeth at right of needle hole (square corner)
20349	1267	Feed Dog
208E	782	“ “ Screw
20283	1315	“ and Feed Lifting Eccentric with 446C
446C	783	“ “ “ “ “ Set Screw
24036	1340	“ “ “ “ “ Sleeve
20284	1350	“ Forked Connection
375C	782	“ “ “ “ Hinge Screw
1518E	783	“ “ “ “ “ Nut
24969	2551	“ Lifting Rock Shaft
24970	—	Feed Lifting Rock Shaft complete, Nos. 12376 and 24969

NO.	PLATE	NAME
12376	770	Feed Lifting Rock Shaft Crank with 157J and 1813
157J	782	Feed Lifting Rock Shaft Crank Clamping Screw
1813	783	Feed Lifting Rock Shaft Crank Roller and Stud
43976	2551	Feed Lifting Rock Shaft Crank Connect- ing Rod with 43977 and two 966E
*43977	—	Feed Lifting Rock Shaft Crank Connect- ing Rod Cap
966E	5806	Feed Lifting Rock Shaft Crank Connect- ing Rod Cap Screw
375C	782	Feed Lifting Rock Shaft Crank Connect- ing Rod Hinge Screw
1518E	783	Feed Lifting Rock Shaft Crank Connect- ing Rod Hinge Screw Nut
307C	783	Feed Lifting Rock Shaft Screw Centre
56814	—	“ “ “ “ “ “ 307C with 1513J
1513J	783	Feed Lifting Rock Shaft Screw Centre Nut
3039	768	“ Regulator
1128E	2009	“ “ Hinge Screw
818D	783	“ “ Thumb Screw
16506	766	“ Rock Shaft
24376	—	Feed Rock Shaft complete, Nos. 16506 and 29633
29633	1354	Feed Rock Shaft Crank with 157J
157J	782	“ “ “ “ Clamping Screw
307C	783	“ “ “ “ Screw Centre
56814	—	“ “ “ “ “ “ 307C with 1513J
1513J	783	Feed Rock Shaft Screw Centre Nut
12381	767	Needle Bar (hollow)
19229	2004	“ “ “ for high lift
12382	770	“ “ Connecting Link with 794E
794E	782	“ “ “ “ Adjusting Screw
*12383	—	Needle Bar Connecting Stud
1904	770	“ “ “ “ Roller (roller only)
453C	783	Needle Bar Connecting Stud Set Screw
12384	770	Needle Bar Connecting Stud complete, Nos. 453C, 1904 and 12383

NO.	PLATE	NAME
20188	767	Needle Bar Crank with 858c and 1065c...
1065c	1366	" " " Position Screw.....
858c	783	" " " Set Screw.....
936E	773	" " Screw Bushing.....
4302	773	" " Thread Guard.....
233d	782	" " " Screw.....
4303	773	" Clamp with 808F, for 12381.....
24101	—	" " Body.....
808F	782	" " Screw.....
24102	1353	" " Thread Guide.....
651D	1353	" " " " Screw.....
24103	1353	Needle Clamp (high lift) complete for 19229, Nos. 651D, 808F, 24101 and 24102
24104	1350	Oscillating Rock Shaft.....
24105	—	Oscillating Rock Shaft complete, Nos. 4784, 12388 and 24104.....
12388	767	Oscillating Rock Shaft Hinge Pin.....
878J	783	" " " " " Oil Hole Stop Screw.....
12459	773	Oscillating Rock Shaft Hinge Pin Oil Hole Stop Screw Washer (leather).....
448c	783	Oscillating Rock Shaft Hinge Pin Set Screw.....
4784	1353	Oscillating Rock Shaft Oil Pad.....
16509	766	" Shaft.....
19496	—	" " Crank for 19447.....
44134	—	" " " " 44135.....
19447	1353	Oscillating Shaft Crank complete, Nos. 457c, 1518E, 19449 and 19496.....
44135	5806	Oscillating Shaft Crank complete, Nos. 1518E, 19449, 44134 and two 453c.....
2049	773	Oscillating Shaft Crank Pin.....
457c	783	" " " Set Screw for 19447
453c	783	" " " " " 44135
19448	1353	" " " Slide Block.....
229D	782	" " " " " Cap Screw.....
12424	773	Oscillating Shaft Crank Slide Block Cap Screw Washer.....
988c	1353	Oscillating Shaft Crank Slide Block Screw Stud.....
1518E	1353	Oscillating Shaft Crank Slide Block Screw Stud Nut.....
19449	1353	Oscillating Shaft Crank Slide Block com- plete, Nos. 229D, 988c, 12424 and 19448

NO.	PLATE	NAME
12391	767	Presser Bar (hollow).....
20059	1341	" " Guide Bracket with 453c....
453c	783	" " " " Set Screw....
2062	771	" " Lifter.....
689c	782	" " " Screw.....
1520E	783	" " " " Nut.....
12327	770	" " Lifting and Releasing Lever Bracket.....
11167	767	Presser Bar Spring (light) .051 wire.....
NOTE: No. 11167 is sent with this Machine unless another Spring is specified on order.		
12139	2004	Presser Bar Spring (medium) .055 wire...
20023	2004	" " " (heavy) .063 wire....
11170	771	" " " Washer.....
12144	780	Presser Foot for 12372, 12437, 12455, 12468, 12481, 20002 and 20336.....
NOTE: No. 12144 is sent with this Machine unless another Presser Foot is specified on order.		
12260	780	Presser Foot for 12137.....
12474	1308	" " " 12372, 12481 and 20002
12261	1308	" " " 12481.....
62527	8376	" " Hinge Pin.....
24544	—	" " Plate.....
24982	—	" " Shank.....
26231	8376	" " Spring.....
24983	781	Presser Foot (hinged) complete for 12481, Nos. 24544, 24982, 26231 and 62527...
2532	772	Presser Foot Hinge Pin.....
20310	—	" " Plate.....
19223	—	" " Shank.....
20311	781	Presser Foot (hinged) complete for 12372, 12437, 12455, 12468, 12481, 20002 and 20336, Nos. 2532, 19223 and 20310....
2532	772	Presser Foot Hinge Pin.....
20344	—	" " Plate.....
20345	—	" " Shank.....
26231	1353	" " Spring.....
20346	781	Presser Foot (spring hinged) complete, Nos. 2532, 20344, 20345 and 26231....
190D	782	Presser Foot Screw.....
688J	783	Pressure Regulating Thumb Screw.....
2996	771	Shuttle Bobbin.....
15140	1353	" " Case Latch.....
2973	771	" " " " Lever.....
2974	771	" " " " " Fulcrum Pin.....

NO.	PLATE	NAME
2975	771	Shuttle Bobbin Case Latch Spring.....
592E	782	" " " " Stop Screw...
15141	—	Shuttle Bobbin Case Hinge, Nos. 2973, 2974 and 15140.....
7553	771	Shuttle Bobbin Case Position Finger.....
2523	771	" " " " " Rivet
24412	1361	" " " " Plate.....
391D	1366	" " " " " Screw
24074	771	Shuttle Bobbin Case complete, Nos. 591F, 592E, 2523, 2975, 7553, 15098 and 15141
12393	771	Shuttle Body.....
591F	782	" Tension Regulating Screw.....
15098	771	" " Spring.....
19292	771	Shuttle, 1 $\frac{1}{4}$ in. diam., Nos. 2996, 12393 and 24074.....
*12394	—	Shuttle Driver.....
12444	771	" " 12394 with two 1266c.....
2049	773	" " Pin.....
1266c	5806	" " Set Screw.....
2531	767	" Race Back.....
2532	772	" " " Position Pin.....
2533	767	" " " Spring.....
907D	782	" " " " Screw.....
24413	—	" " Body.....
25000	—	" " " 24413 with 24414 and two 1053D.....
24414	1362	Shuttle Race Cap.....
1053D	2006	" " " Screw.....
24415	1361	Shuttle Race complete, Nos. 907D, 2531, 2533, 24412, 25000 and two each 391D and 2532.....
145D	782	Shuttle Race Screw.....
12431	—	" " Slide.....
12432	2004	Shuttle Race Slide complete, Nos. 4307, 12431 and two 725E.....
4307	772	Shuttle Race Slide Spring.....
725E	1387	" " " " Screw.....
20060	1311	Slack Thread Regulator.....
225F	1323	" " " Adjusting Screw
2102	5806	Tension Disc.....
1560c	783	" Regulating Thumb Nut.....
32572	5806	" Releasing Disc.....
43944	5806	" " Lever.....
12398	773	" " " Hinge Pin.....
12329	772	" " " Spring.....
32574	5806	" " Pin.....

NO.	PLATE	NAME
50327c	5806	Tension Screw Stud.....
44141	—	" " " 50327c with 1560c...
43945	5806	" Spring.....
44118	—	Tension complete, Nos. 7336, 32572, 32574, 43945, 43946, 44141 and two 2102
52454	5842	Thread Retainer.....
50429c	—	" " Set Screw.....
12404	770	" Take-up Crank.....
3094	773	" " " Wedge.....
690E	782	" " " " Screw.....
12408	770	" " Lever.....
775E	782	" " " Cap Screw.....
12166	773	" " " Hinge Pin.....
12409	770	" " " Link.....
11204	770	" " " " Hinge Pin.....
435c	5806	" " " " " " Set Screw.....
12410	—	Thread Take-up Lever complete, Nos. 12166, 12408 and 12409.....
43946	5806	Thread Take-up Spring.....
7336	772	" " " Regulator.....
448c	783	" " " " Set Screw
20337	—	Throat Plate, large needle hole, for 20336
20338	1264	" " small needle hole, for 20336
NOTE: No. 20338 is sent with this Machine unless another Throat Plate is specified on order.		
12469	—	Throat Plate, large needle hole, for 12468 and 20471.....
12470	777	Throat Plate, small needle hole, for 12468 and 20471.....
12482	—	Throat Plate, large needle hole, for 12481 and 43978.....
12483	778	Throat Plate, small needle hole, for 12481 and 43978.....
12456	779	Throat Plate, small needle hole, for 12455
12414	—	" " large needle hole, for 12372 and 20002.....
12442	778	Throat Plate, small needle hole, for 12372 and 20002.....
12465	—	Throat Plate, large needle hole, for 12437
12440	777	" " small needle hole, for 12437
20350	1267	" " large needle hole, for 20349
20351	—	" " small needle hole, for 20349
691F	782	" " Screw.....
24079	2644	Drip Pan with four 1 in. wire nails.....

LIST OF PARTS COMPLETE

FOR

MACHINE No. 44-3

FOR COLLAR AND CUFF WORK. DROP FEED

NO.	PLATE	NAME
*16501	—	Arm with 11104.....
8582	773	" Dowel Pin.....
12453	773	" Oil Tube for intermediate bearing....
12454	773	" " " with 29599, for oiling 12409
11119	773	" " " " " " " 12408
24131	2014	" " " " " " " 20283
29599	2014	" " " Packing (felt).....
748E	782	" Screw (back).....
868E	1366	" " (front).....
16511	1349	" Shaft.....
*11104	—	" " Bushing (front).....
12357	767	" " Flanged Bushing (back).....
448c	783	" " " " " " Set Screw.....
144D	782	Arm Shaft Screw.....
12480	767	" Side Cap.....
219D	774	" " " Screw.....
12193	2004	" " Cover.....
286D	783	" " " Thumb Screw.....
12403	772	" Spool Pin and Thread Eyelet.....
11241	2003	" " " Washer (cloth).....
24296	1348	Balance Wheel (power) light rim, 2 1/8 in. pulley, with two 448c.....
24297	1340	Balance Wheel Oil Cover.....
210D	1343	" " " " Screw.....
448c	783	" " Set Screw.....
*16503	—	Bed.....
20197	1350	Crank Connecting Rod with 20198 and two 896E.....
*20198	—	Crank Connecting Rod Cap.....
896E	773	" " " " Screw.....
908c	773	" " " Hinge Screw.....
1619E	773	" " " " " Nut..
20057	—	Face Plate.....
20058	1340	Face Plate complete, Nos. 2827, 12150 and 20057.....

NO.	PLATE	NAME
190D	782	Face Plate Screw.....
44181	—	" " Thread Guard (lower).....
12150	773	" " " " " 44181 with 12152.....
12152	773	Face Plate Thread Guard (lower) Rivet
2827	773	" " " " (upper) with S505.....
S505	773	Face Plate Thread Guard (upper) Rivet..
286D	783	" " Thumb Screw.....
12368	767	Feed Bar.....
313c	783	" " Screw Centre.....
56813	—	" " " " 313c with 1519J..
1519J	783	" " " " Nut.....
3033	770	" Connecting Link.....
375c	782	" " " Hinge Screw.....
1518E	783	" " " " " Nut..
12460	775	" Dog.....

NOTE: No. 12160 is sent with this Machine unless another Feed Dog is specified on order.

12433	775	Feed Dog.....
12471	775	" ".....
20369	775	" " 16 teeth (18 teeth to the inch)
208E	782	" " Screw.....
20283	1315	" and Feed Lifting Eccentric with 446c
446c	783	" " " " " Set Screw
24036	1340	" " " " " Sleeve....
20284	1350	" Forked Connection.....
375c	782	" " " Hinge Screw....
1518E	783	" " " " " Nut
24969	2551	" Lifting Rock Shaft.....
24970	—	Feed Lifting Rock Shaft complete, Nos. 12376 and 24969.....
12376	770	Feed Lifting Rock Shaft Crank with 157J and 1813.....
157J	782	Feed Lifting Rock Shaft Crank Clamping Screw.....
1813	783	Feed Lifting Rock Shaft Crank Roller and Stud.....
43976	2551	Feed Lifting Rock Shaft Crank Connect- ing Rod with 43977 and two 966E.....
*43977	—	Feed Lifting Rock Shaft Crank Connect- ing Rod Cap.....
966E	5806	Feed Lifting Rock Shaft Crank Connect- ing Rod Cap Screw.....
375c	782	Feed Lifting Rock Shaft Crank Connect- ing Rod Hinge Screw.....

NO.	PLATE	NAME
1518E	783	Feed Lifting Rock Shaft Crank Connecting Rod Hinge Screw Nut.....
307C	783	Feed Lifting Rock Shaft Screw Centre... ..
56814	—	“ “ “ “ “ “ 307c with 1513J.....
1513J	783	Feed Lifting Rock Shaft Screw Centre Nut.....
3039	768	“ Regulator.....
1128E	2009	“ “ Hinge Screw.....
818D	783	“ “ Thumb Screw.....
24585	8375	“ “ “ “ Stop.....
16506	766	“ Rock Shaft.....
24376	—	Feed Rock Shaft complete, Nos. 16506 and 29633.....
29633	1354	Feed Rock Shaft Crank with 157J.....
157J	782	“ “ “ “ Clamping Screw.....
307C	783	“ “ “ Screw Centre.....
56814	—	“ “ “ “ “ “ 307c with 1513J.....
1513J	783	Feed Rock Shaft Screw Centre Nut.....
12381	767	Needle Bar (hollow).....
19229	2004	“ “ “ “ for high lift.....
12382	770	“ “ Connecting Link with 794E... ..
794E	782	“ “ “ “ Adjusting Screw.....
*12383	—	Needle Bar Connecting Stud.....
1904	770	“ “ “ “ Roller (roller only).....
453C	783	Needle Bar Connecting Stud Set Screw... ..
12384	770	Needle Bar Connecting Stud complete, Nos. 453C, 1904 and 12383.....
20188	767	Needle Bar Crank with 858C and 1065C... ..
1065C	1366	“ “ “ Position Screw.....
858C	783	“ “ “ Set Screw.....
936E	773	“ “ Screw Bushing.....
4302	773	“ “ Thread Guard.....
233D	782	“ “ “ “ Screw.....
4303	773	“ Clamp with 808F.....
24101	—	“ “ Body.....
808F	782	“ “ Screw.....
24102	1353	“ “ Thread Guide.....
651D	1353	“ “ “ “ Screw.....
24103	1353	Needle Clamp (high lift) complete for 19229, Nos. 651D, 808F, 24101 and 24102.....
24104	1350	Oscillating Rock Shaft.....
24105	—	Oscillating Rock Shaft complete, Nos. 4784, 12388 and 24104.....

NO.	PLATE	NAME
12388	767	Oscillating Rock Shaft Hinge Pin.....
878J	783	“ “ “ “ “ Oil Hole Stop Screw.....
12459	773	Oscillating Rock Shaft Hinge Pin Oil Hole Stop Screw Washer (leather).....
448C	783	Oscillating Rock Shaft Hinge Pin Set Screw.....
4784	1353	Oscillating Rock Shaft Oil Pad.....
16509	766	“ Shaft.....
19496	—	“ “ Crank for 19447.....
44134	—	“ “ “ “ 44135.....
19447	1353	Oscillating Shaft Crank complete, Nos. 457C, 1518E, 19449 and 19496.....
44135	5806	Oscillating Shaft Crank complete, Nos. 1518E, 19449, 44134 and two 453C....
2049	773	Oscillating Shaft Crank Pin.....
457C	783	“ “ “ Set Screw for 19447.....
453C	783	“ “ “ “ “ 44135.....
19448	1353	“ “ “ Slide Block.....
229D	782	“ “ “ “ “ Cap Screw.....
12424	773	Oscillating Shaft Crank Slide Block Cap Screw Washer.....
988C	1353	Oscillating Shaft Crank Slide Block Screw Stud.....
1518E	783	Oscillating Shaft Crank Slide Block Screw Stud Nut.....
19449	1353	Oscillating Shaft Crank Slide Block complete, Nos. 229D, 988C, 12424 and 19448.....
12391	767	Presser Bar (hollow).....
20059	1341	“ “ Guide Bracket with 453C... ..
453C	783	“ “ “ “ Set Screw.....
2062	771	“ “ Lifter.....
689C	782	“ “ “ Screw.....
1520E	783	“ “ “ “ Nut.....
12327	770	“ “ Lifting and Releasing Lever Bracket.....
11167	767	Presser Bar Spring (light) .051 wire.....
NOTE: No. 11167 is sent with this Machine unless another Spring is specified on order.		
12139	2004	Presser Bar Spring (medium) .055 wire... ..
20023	2001	“ “ “ (heavy) .063 wire... ..
11170	771	“ “ “ Washer.....

NO.	PLATE	NAME
12435	780	Presser Foot with 228D, for 12433, 12460, 12471 and 25967
NOTE: No. 12435 is sent with this Machine unless another Presser Foot is specified on order.		
12462	781	Presser Foot, for $\frac{3}{16}$ in. to $\frac{1}{4}$ in. gauge
NOTE: When ordering No. 12462, give width of turned edge from seam.		
12463	781	Presser Foot with Strip Guide
26276	1394	" " Hinge Pin
20133	—	" " Plate
19223	—	" " Shank
20134	1308	Presser Foot (hinged) complete, for $\frac{3}{16}$ in. to $\frac{1}{4}$ in. gauge, Nos. 19223, 20133 and 26276
NOTE: When ordering No. 20134, give width of turned edge from seam.		
2532	772	Presser Foot Hinge Pin
20155	—	" " Plate
20156	—	" " Shank
20157	1309	Presser Foot (hinged) complete for 12433, 12460, 12471 and 25967, Nos. 228D, 2532, 20155 and 20156
26276	1394	Presser Foot Hinge Pin
20360	—	" " Plate
19335	—	" " Shank
20361	781	Presser Foot (hinged) plain bottom, complete, Nos. 19335, 20360 and 26276
26279	—	Presser Foot Extension, $\frac{1}{16}$ in., for 12435 and 20157
26280	—	Presser Foot Extension, $\frac{1}{8}$ in., for 12435 and 20157
26281	1387	Presser Foot Extension, $\frac{1}{4}$ in., for 12435 and 20157
26282	—	Presser Foot Extension, $\frac{3}{8}$ in., for 12435 and 20157
26283	—	Presser Foot Extension, $\frac{1}{2}$ in., for 12435 and 20157
228D	2038	Presser Foot Extension Screw
190D	782	" " Screw
25967	1387	" " Strip Gauge for 12435 and 20157
228D	2038	Presser Foot Strip Gauge Screw
NOTE: Nos. 25967 and 26279 to 26283 are sent with this Machine unless otherwise specified on order.		

NO.	PLATE	NAME
688J	783	Pressure Regulating Thumb Screw
2996	771	Shuttle Bobbin
15140	1353	" " Case Latch
2973	771	" " " " Lever
2974	771	" " " " " Fulcrum Pin
2975	771	Shuttle Bobbin Case Latch Spring
592E	782	" " " " Stop Screw
15141	—	Shuttle Bobbin Case Hinge, Nos. 2973, 2974 and 15140
7553	771	Shuttle Bobbin Case Position Finger
2523	771	" " " " " Rivet
24412	1364	" " " " " Plate
391D	1366	" " " " " Screw
24074	771	Shuttle Bobbin Case complete, Nos. 591E, 592E, 2523, 2975, 7553, 15098 and 15141
12393	771	Shuttle Body
591E	782	" Tension Regulating Screw
15098	771	" " Spring
19292	771	Shuttle, $1\frac{1}{16}$ in. diam., Nos. 2996, 12393 and 24074
*12394	—	Shuttle Driver
12444	771	" " 12394 with two 1266C
2049	773	" " Pin
1266C	5806	" " Set Screw
2531	767	" Race Back
2532	772	" " Position Pin
2533	767	" " " Spring
907D	782	" " " " Screw
24416	—	" " Body
24414	1362	" " Cap
1053D	2006	" " " Screw
24417	1362	Shuttle Race complete, Nos. 907D, 2531, 2533, 24412, 24414, 24416 and two each 391D, 1053D and 2532
145D	782	Shuttle Race Screw
12431	—	" " Slide
12432	2004	Shuttle Race Slide complete, Nos. 4307, 12431 and two 725E
4307	772	Shuttle Race Slide Spring
725E	1387	" " " " Screw
20060	1344	Slack Thread Regulator
225F	4323	" " " Adjusting Screw
2102	5806	Tension Disc
1560C	783	" Regulating Thumb Nut
32572	5806	" Releasing Disc

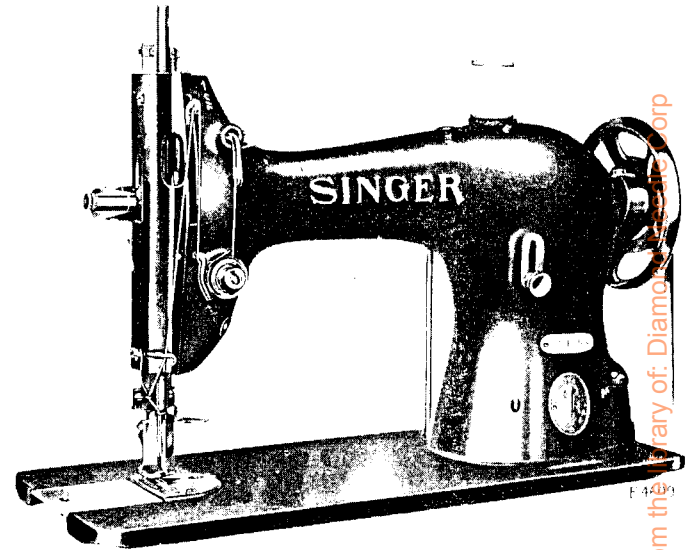
NO.	PLATE	NAME
43944	5806	Tension Releasing Lever
12398	773	" " " Hinge Pin
12329	772	" " " Spring
32574	5806	" " Pin
50327c	5806	" Screw Stud
44141	—	" " 50327c with 1560c.
43945	5806	" Spring
44118	—	Tension complete, Nos. 7336, 32572, 32574, 43945, 43946, 41141 and two 2102
52454	5842	Thread Retainer
50429c	—	" " Set Screw
12404	770	" Take-up Crank
3094	773	" " " Wedge
690E	782	" " " Screw
12408	770	" " Lever
775E	782	" " " Cap Screw
12166	773	" " " Hinge Pin
12409	770	" " " Link
11204	770	" " " " Hinge Pin
435c	5806	" " " " " " " Set Screw
12410	—	Thread Take-up Lever complete, Nos. 12166, 12408 and 12409
43946	5806	Thread Take-up Spring
7336	772	" " " Regulator
448c	783	" " " Set Screw
12461	775	Throat Plate, small needle hole, for 12460
NOTE: No. 12461 is sent with this Machine unless another Throat Plate is specified on order.		
12434	775	Throat Plate, small needle hole, for 12433
12472	—	" " medium needle hole, for 12471 and 20369
12473	775	Throat Plate, small needle hole, for 12471 and 20369
691F	782	Throat Plate Screw
24079	2644	Drip Pan with four 1 in. wire nails

SPOOL HOLDER (Disc)

26763	1352	Bracket with 219F and 287D
219F	774	" Screw
287D	2636	" Thumb Screw
19066	1352	Spindle
19067	1352	" Thread Guiding Disc
691F	782	" " " " Screw
26764	1352	Spool Holder (disc) complete, Nos. 691F, 19066, 19067 and 26763

LIST OF PARTS COMPLETE

FOR



From the Library of: Diamond Corp

MACHINE No. 44-8

OR LIGHT OR HEAVY CLOTH. HAS VERTICAL TRIMMER THAT TRIMS FROM $\frac{1}{16}$ TO $\frac{1}{4}$ INCH FROM THE SEAM. DROP FEED. MACHINES ARE FITTED WITH $\frac{1}{8}$ INCH CUTTING BAR UNLESS OTHERWISE ORDERED, AND AN EXTRA $\frac{3}{16}$ INCH CUTTING BAR AND PRESSER FOOT ARE ALSO FURNISHED. WHEN A DIFFERENT WIDTH IS ORDERED, THE EXTRA CUTTING BAR WILL BE ONE SIZE LARGER EXCEPT WHEN $\frac{1}{4}$ INCH IS REQUIRED.

NO.	PLATE	NAME
*16557	—	Arm with 11104.....
8582	773	" Dowel Pin.....
12453	773	" Oil Tube for intermediate bearing... ..
12454	773	" " " with 29599, for oiling 12409.....
11119	773	" " " " " " " " 12408 and 16569.....
24131	2014	Arm Oil Tube with 29599, for oiling 20283.....
29599	2014	" " " Packing (felt).....
748E	782	" Screw (back).....
868E	1366	" " (front).....
16511	1349	" Shaft.....
*11104	—	" " Bushing (front).....
12357	767	" " Flanged Bushing (back).....
448C	783	" " " " " " Set Screw.....
144D	782	Arm Shaft Screw.....
12193	2004	" Side Cover.....
286D	783	" " " Thumb Screw.....
12403	772	" Spool Pin and Thread Eyelet.....
11241	2003	" " " Washer (cloth).....
24296	1348	Balance Wheel (power) light rim, 2 $\frac{3}{8}$ in. pulley, with two 448C.....
24297	1340	Balance Wheel Oil Cover.....
210D	1343	" " " " Screw.....
448C	783	" " Set Screw.....
*16596	—	Bed.....
20197	1350	Crank Connecting Rod with 20198 and two 896E.....
*20198	—	Crank Connecting Rod Cap.....
896E	773	" " " " " Screw.....
908C	773	" " " " " Hinge Screw.....
1619E	773	" " " " " " Nut
16558	—	Face Plate.....
16559	1351	Face Plate complete, Nos. 2827, 12150 and 16558.....
217D	1312	Face Plate Screw.....
44181	—	" " Thread Guard (lower).....
12150	773	" " " " " " 44181 with 12152.....
12152	773	Face Plate Thread Guard (lower) Rivet
2827	773	" " " " " (upper) with 8505.....
8505	773	Face Plate Thread Guard (upper) Rivet.
12368	767	Feed Bar.....
313C	783	" " Screw Centre.....
56813	—	" " " " 313C with 1519J... ..
1519J	783	" " " " Nut.....

NO.	PLATE	NAME
3033	770	Feed Connecting Link.....
375c	782	" " " " Hinge Screw.....
1518E	783	" " " " " " Nut..
24573	1271	" Dog, 24 teeth (32 teeth to the inch)
19103	1271	" " 12 teeth (16 teeth to the inch)
208E	782	" " Screw.....
20283	1315	" and Feed Lifting Eccentric with 446c
446c	783	" " " " " Set Screw
24036	1340	" " " " " Sleeve...
20284	1350	" Forked Connection.....
375c	782	" " " " Hinge Screw....
1518E	783	" " " " " " Nut
24969	2551	" Lifting Rock Shaft.....
24970	—	Feed Lifting Rock Shaft complete, Nos. 12376 and 24969.....
12376	770	Feed Lifting Rock Shaft Crank with 157J and 183.....
157J	782	Feed Lifting Rock Shaft Crank Clamping Screw.....
1813	783	Feed Lifting Rock Shaft Crank Roller and Stud.....
43976	2551	Feed Lifting Rock Shaft Crank Connecting Rod with 43977 and two 966E.....
*43977	—	Feed Lifting Rock Shaft Crank Connecting Rod Cap.....
966E	5806	Feed Lifting Rock Shaft Crank Connect- ing Rod Cap Screw.....
375c	782	Feed Lifting Rock Shaft Crank Connect- ing Rod Hinge Screw.....
1518E	783	Feed Lifting Rock Shaft Crank Connect- ing Rod Hinge Screw Nut.....
307c	783	Feed Lifting Rock Shaft Screw Centre... ..
56814	—	" " " " " " 307c with 1513J.....
1513J	783	Feed Lifting Rock Shaft Screw Centre Nut
3039	768	" Regulator.....
1128E	2009	" " Hinge Screw.....
818D	783	" " Thumb Screw.....
16506	766	" Rock Shaft.....
24376	—	Feed Rock Shaft complete, Nos. 16506 and 29633.....
29633	1354	Feed Rock Shaft Crank with 157J.....
157J	782	" " " " Clamping Screw..
307c	783	" " " " Screw Centre.....
56814	—	" " " " " " 307c with 1513J.....
1513J	783	Feed Rock Shaft Screw Centre Nut.....

NO.	PLATE	NAME
5726	1271	Knife.....
NOTE: Two No. 5726 are sent with this Machine.		
620F	782	Knife Adjusting Screw.....
19297	1315	" Bar with 2301.....
24431	1352	" " Crank with 191c.....
1162c	1366	" " " Coupling Pin.....
1564D	2442	" " " " Head....
2297	2442	" " " " Spring....
2022	773	" " " Pin.....
191c	1366	" " " Set Screw.....
24432	—	Knife Bar Crank complete, Nos. 1162c, 1564D, 2297 and 24431.....
16563	1315	Knife Bar Driving Crank (forked).....
16564	1315	" " " " Bracket.....
24433	—	Knife Bar Driving Crank Bracket complete, Nos. 2022, 16563, 16564 and 24432.....
647c	774	Knife Bar Driving Crank Bracket Screw.....
24122	1317	" " Lifting Spring.....
24123	1317	" " " Case.....
24124	1317	" " " " Guide.....
*24906	—	" " " " " 24124 with 2523 and 24125.....
24125	1317	Knife Bar Lifting Spring Guide Bracket... ..
621D	1317	" " " " " " Screw.....
2523	1317	" " " " " Pin.....
2301	1317	" " Stop Pin.....
24128	—	Knife Bar complete, Nos. 621D, 19297, 19391, 24109, 24906 and three 335H....
19391	8376	Knife Holder with 620F, 2291 and two 223F.....
24109	8376	" " Handle.....
335H	1317	" " " Screw.....
335H	1317	" " " Screw.....
223F	1317	" Screw.....
2291	1317	" Washer.....
16568	1352	Needle Bar with 620F, 1072F and 24391 ..
12382	770	" " Connecting Link with 794E..
794E	782	" " " " Adjusting Screw.....
*12383	—	Needle Bar Connecting Stud.....
1904	770	" " " " Roller (roller only).....
453c	783	Needle Bar Connecting Stud Set Screw.....
12384	770	Needle Bar Connecting Stud complete, Nos. 453c, 1904 and 12383.....
16569	1315	Needle Bar Crank (eccentric) with 448c and 743c.....

NO.	PLATE	NAME
743c	1317	Needle Bar Crank Position Screw.....
448c	783	" " " Set Screw.....
24391	8376	" " Thread Guard.....
620F	782	" " " " Set Screw....
1072F	1317	" Set Screw.....
24104	1350	Oscillating Rock Shaft.....
24105	—	Oscillating Rock Shaft complete, Nos. 4784, 12388 and 24104.....
12388	767	Oscillating Rock Shaft Hinge Pin.....
878J	783	" " " " " Oil Hole Stop Screw.....
12459	773	Oscillating Rock Shaft Hinge Pin Oil Hole Stop Screw Washer (leather).....
448c	783	Oscillating Rock Shaft Hinge Pin Set Screw.....
4784	1353	Oscillating Rock Shaft Oil Pad.....
16509	766	" Shaft.....
19496	—	" " Crank for 19447.....
44134	—	" " " " 44135.....
19447	1353	Oscillating Shaft Crank complete, Nos. 457c, 1518E, 19449 and 19496.....
44135	5806	Oscillating Shaft Crank complete, Nos. 1518E, 19449, 44134 and two 453c....
2019	773	Oscillating Shaft Crank Pin.....
457c	783	" " " Set Screw for 19447.....
453c	783	" " " " " 44135.....
19448	1353	" " " Slide Block.....
229D	782	" " " " " Cap Screw.....
12424	773	Oscillating Shaft Crank Slide Block Cap Screw Washer.....
988c	1353	Oscillating Shaft Crank Slide Block Screw Stud.....
1518E	783	Oscillating Shaft Crank Slide Block Screw Stud Nut.....
19449	1353	Oscillating Shaft Crank Slide Block complete, Nos. 229D, 988c, 12424 and 19448.....
12391	767	Presser Bar (hollow).....
12326	770	" " Guide Bracket with 453c....
453c	783	" " " " Set Screw....
2062	771	" " Lifter.....
689c	782	" " " Screw.....
1520E	783	" " " " Nut.....
12327	770	" " Lifting and Releasing Lever Bracket.....

NO.	PLATE	NAME
11167	767	Presser Bar Spring (light) .051 wire.....
NOTE: No. 11167 is sent with this Machine unless another Spring is specified on order.		
12139	2004	Presser Bar Spring (medium) .055 wire...
20023	2004	“ “ “ (heavy) .063 wire....
11170	771	“ “ “ Washer.....
24722	1271	“ Foot, $\frac{1}{8}$ in. to $\frac{1}{4}$ in. gauge, for 19103 and 24573.....
19392	1271	Presser Foot, $\frac{1}{8}$ in. gauge and above, for 19103 and 24573.....
NOTE: No. 24722 $\frac{1}{4}$ in. gauge, and No. 19392, $\frac{1}{8}$ in. gauge, are sent with this Machine unless other gauges are specified on order.		
190D	782	Presser Foot Screw.....
688J	783	Pressure Regulating Thumb Screw.....
2996	771	Shuttle Bobbin.....
15140	1353	“ “ Case Latch.....
2973	771	“ “ “ “ Lever.....
2974	771	“ “ “ “ Fulcrum Pin.....
2975	771	Shuttle Bobbin Case Latch Spring.....
592E	782	“ “ “ “ Stop Screw....
15141	—	Shuttle Bobbin Case Hinge, Nos. 2973, 2974 and 15140.....
7553	771	Shuttle Bobbin Case Position Finger.....
2523	771	“ “ “ “ “ Rivet.....
24412	1361	“ “ “ “ Plate.....
391D	1366	“ “ “ “ “ Screw.....
24074	771	Shuttle Bobbin Case complete, Nos. 591F, 592E, 2523, 2975, 7553, 15098 and 15141
12393	771	Shuttle Body.....
591F	782	“ Tension Regulating Screw.....
15098	771	“ “ Spring.....
19292	771	Shuttle, $1\frac{1}{4}$ in. diam., Nos. 2996, 12393 and 24074.....
*12394	—	Shuttle Driver.....
12444	771	“ “ 12394 with two 1266c....
2049	773	“ “ Pin.....
1266c	5806	“ “ Set Screw.....
2531	767	“ Race Back.....
2532	772	“ “ “ Position Pin.....
2533	767	“ “ “ Spring.....
907D	782	“ “ “ “ Screw.....
24413	—	“ “ Body.....
62502	—	“ “ “ 24413 with 24418 and two 1053D, for 62517.....

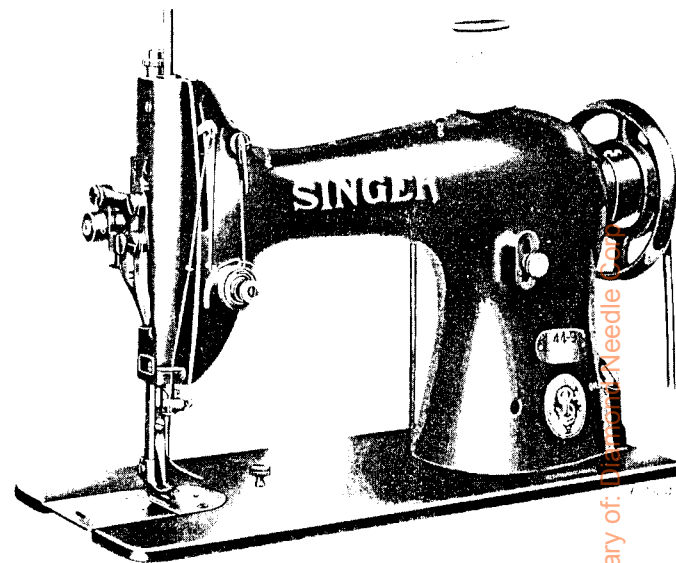
NO.	PLATE	NAME
62517	—	Shuttle Race Body 62502 with two 2532, for 24419.....
24418	1362	Shuttle Race Cap.....
1053D	2006	“ “ “ Screw.....
24419	1362	Shuttle Race complete, Nos. 907D, 2531, 2533, 24412, 62517 and two 391D.....
145D	782	Shuttle Race Screw.....
12431	—	“ “ Slide.....
12432	2004	Shuttle Race Slide complete, Nos. 4307, 12431 and two 725E.....
4307	772	Shuttle Race Slide Spring.....
725E	1387	“ “ “ “ Screw.....
2102	5806	Tension Disc.....
1560C	783	“ Regulating Thumb Nut.....
32572	5806	“ Releasing Disc.....
43944	5806	“ “ Lever.....
12398	773	“ “ “ Hinge Pin.....
12329	772	“ “ “ Spring.....
32574	5806	“ “ Pin.....
50327C	5806	“ Screw Stud.....
44141	—	“ “ “ 50327c with 1560c.....
43945	5806	“ Spring.....
44118	—	Tension complete, Nos. 7336, 32572, 32574, 43945, 43946, 44141 and two 2102
12149	2014	Tension Thread Guard.....
52454	5842	Thread Retainer.....
50429C	—	“ “ Set Screw.....
12404	770	“ Take-up Crank.....
3094	773	“ “ “ Wedge.....
690E	782	“ “ “ “ Screw....
12408	770	“ “ “ Lever.....
775E	782	“ “ “ Cap Screw.....
12166	773	“ “ “ Hinge Pin.....
12409	770	“ “ “ Link.....
11204	770	“ “ “ “ Hinge Pin... ..
435C	5806	“ “ “ “ “ “ Set Screw.....
12410	—	Thread Take-up Lever complete, Nos. 12166, 12408 and 12409.....
43946	5806	Thread Take-up Spring.....
7336	772	“ “ “ Regulator.....
448C	783	“ “ “ “ Set Screw.....

From the library of: Diamond Needle Corp.

NO.	PLATE	NAME
5729	—	Throat Plate Body
5730	1271	“ “ Cutting Bar
NOTE: When ordering No. 5730, state required distance of trimmed edge from seam.		
NOTE: No. 5730, $\frac{3}{16}$ in. gauge, is sent with this Machine unless otherwise specified on order.		
578D	8376	Throat Plate Cutting Bar Screw
5731	1271	“ “ Slide
578D	8376	“ “ “ Adjusting Screw
5732	1271	Throat Plate complete for 19103 and 24573, Nos. 5729 to 5731 and three 578D
NOTE: When ordering No. 5732, state required distance of trimmed edge from seam.		
NOTE: No. 5732, $\frac{1}{8}$ in. gauge, is sent with this Machine unless otherwise specified on order.		
691F	782	Throat Plate Screw
24079	2644	Drip Pan with four 1 in. wire nails

62942

LIST OF PARTS COMPLETE FOR



MACHINE No. 44-9

FOR CLOTH OR LEATHER. USEFUL FOR WORK OF UNEQUAL THICKNESS AND FOR BINDING WITH BINDERS OF DIFFERENT WIDTHS. DROP FEED. ALTERNATING PRESSERS.

NO.	PLATE	NAME
*19353	—	Arm with 11104
8582	773	“ Dowel Pin
12453	773	“ Oil Tube for intermediate bearing
12454	773	“ “ “ with 29599, for oiling 12409
11119	773	“ “ “ “ “ “ “ 12408 and 19365
24131	2014	Arm Oil Tube with 29599, for oiling 20283
29599	2014	“ “ “ Packing (felt)
748E	782	“ Screw (back)
868E	1366	“ “ (front)

NO.	PLATE	NAME
16511	4349	Arm Shaft
11104	—	" " Bushing (front)
12357	767	" " Flanged Bushing (back)
448c	783	" " " " " " Set Screw
144d	782	Arm Shaft Screw
12193	2001	" Side Cover
286d	783	" " " Thumb Screw
12403	772	" Spool Pin and Thread Eyelet
11241	2003	" " " Washer (cloth)
24296	1348	Balance Wheel (power) light rim, 2 1/4 in. pulley, with two 448c
24297	1340	Balance Wheel Oil Cover
210b	1343	" " " " Screw
448c	783	" " " " Set Screw
*24454	—	Bed
20197	1350	Crank Connecting Rod with 20198 and two 896E
*20198	—	Crank Connecting Rod Cap
896E	773	" " " " " Screw
908c	773	" " " " Hinge Screw
1619E	773	" " " " " Nut
19354	—	Face Plate
19355	1311	Face Plate complete, Nos. 2827, 12150 and 19354
219d	771	Face Plate Screw
44181	—	" " Thread Guard (lower)
12150	773	" " " " " " 44181 with 12152
12152	773	Face Plate Thread Guard (lower) Rivet
2827	773	" " " " " (upper) with 8505
8505	773	" " " " " Rivet
12368	767	Feed Bar
313c	783	" " Screw Centre
56813	—	" " " " " 313c with 1519J
1519J	783	" " " " " Nut
3033	770	" Connecting Link
375c	782	" " " Hinge Screw
1518E	783	" " " " " Nut
12370	778	Feed Dog, 15 teeth (16 teeth to the inch)
NOTE: No. 12370 is sent with this Machine unless another Feed Dog is specified on order.		
43979	778	Feed Dog, 21 teeth (22 teeth to the inch)
12369	776	" " 12 teeth (12 teeth to the inch)
12457	776	" " 16 teeth (16 teeth to the inch)
20106	1259	" "

NO.	PLATE	NAME
208E	782	Feed Dog Screw
20283	1315	" and Feed Lifting Eccentric with 446c
446c	783	" " " " " " Set Screw
24036	1340	" " " " " Sleeve
20284	1350	" Forked Connection
375c	782	" " " " Hinge Screw
1518E	783	" " " " " " Nut
24969	2551	" Lifting Rock Shaft
24970	—	Feed Lifting Rock Shaft complete, Nos. 12376 and 24969
12376	770	Feed Lifting Rock Shaft Crank with 157J and 1813
157J	782	Feed Lifting Rock Shaft Crank Clamping Screw
1813	783	Feed Lifting Rock Shaft Crank Roller and Stud
43976	2551	Feed Lifting Rock Shaft Crank Connecting Rod with 43977 and two 966E
*43977	—	Feed Lifting Rock Shaft Crank Connecting Rod Cap
966E	5806	Feed Lifting Rock Shaft Crank Connecting Rod Cap Screw
375c	782	Feed Lifting Rock Shaft Crank Connecting Rod Hinge Screw
1518E	783	Feed Lifting Rock Shaft Crank Connecting Rod Hinge Screw Nut
307c	783	Feed Lifting Rock Shaft Screw Centre
56814	—	" " " " " " 307c with 1513J
1513J	783	Feed Lifting Rock Shaft Screw Centre Nut
3039	768	" Regulator
1128E	2009	" " Hinge Screw
818d	783	" " Thumb Screw
16506	766	" Rock Shaft
24376	—	Feed Rock Shaft complete, Nos. 16506 and 29633
29633	1354	Feed Rock Shaft Crank with 157J
157J	782	" " " " Clamping Screw
307c	783	" " " " Screw Centre
56814	—	" " " " " " 307c with 1513J
1513J	783	Feed Rock Shaft Screw Centre Nut
12391	767	Lifting Presser Bar (hollow)
19356	1312	" " " Bell Crank
199d	1312	" " " " " Cap Screw
19357	1312	" " " " " Connecting Link

NO.	PLATE	NAME
199D	1312	Lifting Presser Bar Bell Crank Connecting Link Cap Screw
19358	1312	Lifting Presser Bar Bell Crank Driving Arm
19362	1313	Lifting Presser Bar Bell Crank Driving Arm Eccentric Connection
375c	782	Lifting Presser Bar Bell Crank Driving Arm Eccentric Connection Hinge Screw
1518E	783	Lifting Presser Bar Bell Crank Driving Arm Eccentric Connection Hinge Screw Nut
2049	773	Lifting Presser Bar Bell Crank Driving Arm Pin
19359	1312	Lifting Presser Bar Bell Crank Driving Arm Shaft
19360	1311	Lifting Presser Bar Bell Crank Driving Arm Shaft Bracket
19361	—	Lifting Presser Bar Bell Crank Driving Arm Shaft Bracket complete, Nos. 2049 and 19358 to 19360
965D	1312	Lifting Presser Bar Bell Crank Driving Arm Shaft Bracket Screw
24589	5736	Lifting Presser Bar Guide Bracket with 453c
24716	—	Lifting Presser Bar Guide Bracket complete, Nos. 19356, 19357, 19366, 24589 and three 199D
453c	783	Lifting Presser Bar Guide Bracket Set Screw
24590	5736	Lifting Presser Bar Guide Bracket Support
175D	5736	" " " " " "
4855	1312	Lifting Presser Bar Lifter
689c	782	" " " " Screw
1520E	783	" " " " Nut
12327	770	" " " Lifting and Releasing Lever Bracket
11167	767	Lifting Presser Bar Spring (light) .051 wire
NOTE: No. 11167 is sent with this Machine unless another Spring is specified on order.		
12139	2004	Lifting Presser Bar Spring (medium) .055 wire
20023	2004	Lifting Presser Bar Spring (heavy) .063 wire

NO.	PLATE	NAME
11170	771	Lifting Presser Bar Spring Washer
19364	1312	" " Foot
19375	1313	" " "
193D	1312	" " " Screw
12381	767	Needle Bar (hollow)
12382	770	" " Connecting Link with 794E
794E	782	" " " " Adjusting Screw
*12383	—	Needle Bar Connecting Stud
1904	770	" " " " Roller (roller only)
453c	783	Needle Bar Connecting Stud Set Screw
12384	770	Needle Bar Connecting Stud complete, Nos. 453c, 1904 and 12383
19365	1311	Needle Bar Crank and Lifting Eccentric with 448c and 743c
743c	1313	Needle Bar Crank and Lifting Eccentric Position Screw
448c	783	Needle Bar Crank and Lifting Eccentric Set Screw
936E	773	Needle Bar Screw Bushing
4302	773	" " Thread Guard
233D	782	" " " " Screw
4303	773	" Clamp with 808F
808F	782	" " Screw
24104	1350	Oscillating Rock Shaft
24105	—	Oscillating Rock Shaft complete, Nos. 4784, 12388 and 24104
12388	767	Oscillating Rock Shaft Hinge Pin
878J	783	" " " " " Oil Hole Stop Screw
12459	773	Oscillating Rock Shaft Hinge Pin Oil Hole Stop Screw Washer (leather)
448c	783	Oscillating Rock Shaft Hinge Pin Set Screw
4784	1353	Oscillating Rock Shaft Oil Pad
16509	766	" Shaft
19496	—	" " Crank for 19447
44134	—	" " " " 44135
19447	1353	Oscillating Shaft Crank complete, Nos. 457c, 1518E, 19449 and 19496
44135	5806	Oscillating Shaft Crank complete, Nos. 1518E, 19449, 44134 and two 453c
2049	773	Oscillating Shaft Crank Pin
457c	783	" " " Set Screw for 19447
453c	783	" " " " " for 44135

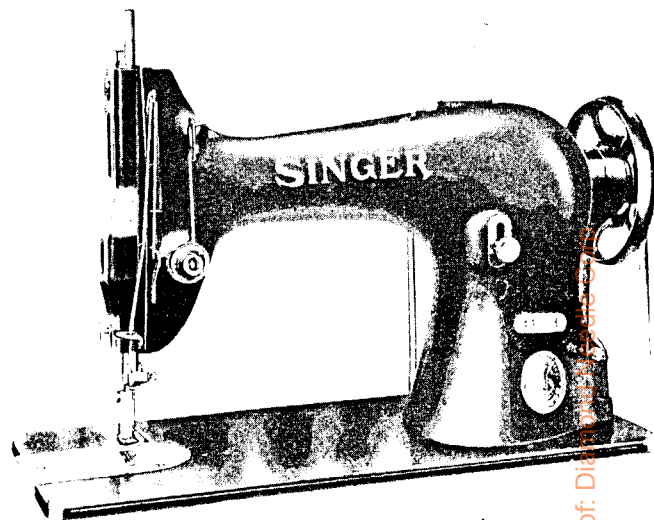
NO.	PLATE	NAME
19448	1353	Oscillating Shaft Crank Slide Block.....
229D	782	“ “ “ “ “ Cap Screw.....
12424	773	Oscillating Shaft Crank Slide Block Cap Screw Washer.....
988c	1353	Oscillating Shaft Crank Slide Block Screw Stud.....
1518E	783	Oscillating Shaft Crank Slide Block Screw Stud Nut.....
19449	1353	Oscillating Shaft Crank Slide Block com- plete, Nos. 229D, 988c, 12424 and 19448
688J	783	Pressure Regulating Thumb Screw.....
2996	771	Shuttle Bobbin.....
15140	1353	“ “ Case Latch.....
2973	771	“ “ “ “ Lever.....
2974	771	“ “ “ “ “ Fulcrum Pin.....
2975	771	Shuttle Bobbin Case Latch Spring.....
592E	782	“ “ “ “ Stop Screw.....
15141	—	Shuttle Bobbin Case Hinge, Nos. 2973, 2974 and 15140.....
7553	771	Shuttle Bobbin Case Position Finger.....
2523	771	“ “ “ “ “ Rivet
24412	1361	“ “ “ “ Plate.....
391D	1366	“ “ “ “ “ Screw
24074	771	Shuttle Bobbin Case complete, Nos. 591F, 592E, 2523, 2975, 7553, 15098 and 15141
24889	8375	Shuttle Body.....
591F	782	“ Tension Regulating Screw.....
15098	771	“ “ Spring.....
24890	8375	Shuttle, 1 $\frac{1}{8}$ in. diam., Nos. 2996, 24074 and 24889.....
*12394	—	Shuttle Driver.....
12444	771	“ “ 12394 with two 1266c....
2049	773	“ “ Pin.....
1266c	5806	“ “ Set Screw.....
2531	767	“ Race Back.....
2532	772	“ “ “ Position Pin.....
2533	767	“ “ “ Spring.....
907D	782	“ “ “ “ Screw.....
24413	—	“ “ Body.....
62502	—	“ “ “ 24413 with 24418 and two 1053D.....
62517	—	Shuttle Race Body 62502 with two 2532..
24418	1362	“ “ Cap.....
1053D	2006	“ “ “ Screw.....

NO.	PLATE	NAME
24419	1362	Shuttle Race complete, Nos. 907D, 2531, 2533, 24412, 62517 and two 391D.....
145D	782	Shuttle Race Screw.....
12431	—	“ “ Slide.....
12432	2004	Shuttle Race Slide complete, Nos. 4307, 12431 and two 725E.....
4307	772	Shuttle Race Slide Spring.....
725E	1387	“ “ “ “ Screw.....
2921	771	Tension Disc.....
1560c	783	“ Regulating Thumb Nut.....
20037	2009	“ Releaser.....
12397	772	“ Releasing Lever.....
12398	773	“ “ “ Hinge Pin.....
12329	772	“ “ “ Spring.....
413c	783	“ Screw Stud.....
33892	—	“ “ “ 413c with 1560c....
2923	771	“ Spring.....
12149	2014	“ Thread Guard.....
44147	—	Tension complete, Nos. 2923, 7336, 8511, 20037, 33892 and two 2921.....
52454	5842	Thread Retainer.....
50429c	—	“ “ Set Screw.....
12404	770	“ Take-up Crank.....
3094	773	“ “ “ Wedge.....
690E	782	“ “ “ “ Screw.....
12408	770	“ “ Lever.....
775E	782	“ “ “ Cap Screw.....
12166	773	“ “ “ Hinge Pin.....
12409	770	“ “ “ Link.....
11204	770	“ “ “ “ Hinge Pin.....
435c	5806	“ “ “ “ “ “ Set Screw.....
12410	—	Thread Take-up Lever complete, Nos. 12166, 12408 and 12409.....
8511	773	Thread Take-up Spring.....
7336	772	“ “ “ Regulator.....
448c	783	“ “ “ “ Set Screw
12412	778	Throat Plate, large needle hole, for 12370 and 43979.....
NOTE: No. 12412 is sent with this Machine unless another Throat Plate is specified on order.		
12411	776	Throat Plate, large needle hole, for 12369 and 12457.....
12449	—	Throat Plate, small needle hole, for 12369 and 12457.....

NO.	PLATE	NAME
20107	1259	Throat Plate, small needle hole, for 20106
691F	782	" " Screw.....
19366	1313	Vibrating Presser Bar.....
19367	1313	" " " Cap.....
199D	1312	" " " " Screw for 19366
219F	774	" " " " " " 19367
19368	1313	" " " Cushion (rawhide)
19369	1313	" " " Spring.....
335D	1313	" " " " Screw.....
19370	1312	" " Foot for 12370 and 43979
19374	1313	" " " 12369 and 12457
19376	1313	" " " " 20106.....
217D	1312	" " " Screw.....
24079	2644	Drip Pan with four 1 in. wire nails.....

LIST OF PARTS COMPLETE

FOR



MACHINE No. 44-13

FOR CLOTH. THROAT PLATE FLUSH WITH BED.
DROP FEED

NO.	PLATE	NAME
*16501	—	Arm with 11104.....
8582	773	" Dowel Pin.....
12453	773	" Oil Tube for intermediate bearing...
12454	773	" " " with 29599, for oiling 12409
11119	773	" " " " " " " 12408
24131	2014	" " " " " " " 20283
29599	2014	" " " Packing (felt).....
748E	782	" Screw (back).....
868E	1366	" " (front).....
16511	1349	" Shaft.....
*11104	—	" Bushing (front).....
12357	767	" " Flanged Bushing (back).....
448c	783	" " " " " Set
		Screw.....

From the library of: Digitized by eGangotri

NO.	PLATE	NAME
144D	782	Arm Shaft Screw.....
12480	767	" Side Cap.....
219D	774	" " " Screw.....
12193	2004	" " " Cover.....
286D	783	" " " Thumb Screw.....
12403	772	" Spool Pin and Thread Eyelet.....
11241	2003	" " " Washer (cloth).....
24296	1348	Balance Wheel (power) light rim, 2 $\frac{3}{16}$ in. pulley, with two 448c.....
24297	1340	Balance Wheel Oil Cover.....
210D	1343	" " " " Screw.....
448c	783	" " " Set Screw.....
*16503	—	Bed.....
20197	1350	Crank Connecting Rod with 20198 and two 896E.....
*20198	—	Crank Connecting Rod Cap.....
896E	773	" " " " Screw.....
908c	773	" " " " Hinge Screw.....
1619E	773	" " " " " Nut
20057	—	Face Plate.....
20058	1340	Face Plate complete, Nos. 2827, 12150 and 20057.....
190D	782	Face Plate Screw.....
44181	—	" " Thread Guard (lower).....
12150	773	" " " " " 44181 with 12152.....
12152	773	Face Plate Thread Guard (lower) Rivet..
2827	773	" " " " (upper) with 8505
8505	773	" " " " " Rivet
286D	783	" " Thumb Screw.....
12368	767	Feed Bar.....
313c	783	" " Screw Centre.....
56813	—	" " " " 313c with 1519J..
1519J	783	" " " " Nut.....
3033	770	" Connecting Link.....
375c	782	" " " Hinge Screw.....
1518E	783	" " " " " Nut..
12369	776	Feed Dog, 12 teeth (12 teeth to the inch)
NOTE: No. 12369 is sent with this Machine unless another Feed Dog is specified on order.		
12457	776	Feed Dog, for cloth, 16 teeth (16 teeth to the inch).....
12425	779	Feed Dog, for cloth.....
12450	777	" " " " 11 teeth (18 teeth to the inch).....

NO.	PLATE	NAME
20348	777	Feed Dog, for chiffon, 22 teeth (36 teeth to the inch).....
12370	778	Feed Dog, for cloth, 15 teeth (16 teeth to the inch).....
43979	778	Feed Dog, for cloth, 21 teeth (22 teeth to the inch).....
20106	1259	Feed Dog, for cloth.....
20117	1261	" " " shirt work, 16 teeth (16 teeth to the inch) beveled for hemmer
20119	1259	Feed Dog, for heavy work on duck, overalls, etc.....
44144	1262	Feed Dog, 22 teeth (24 teeth to the inch) beveled for hemmer.....
20138	1263	Feed Dog, for shirt work, 13 teeth (12 teeth to the inch) beveled for hemmer
20147	1260	Feed Dog, 12 teeth (14 teeth to the inch)
44177	1260	" " 19 teeth (22 teeth to the inch)
44156	1262	" " 24 teeth (24 teeth to the inch)
20151	1262	" " 13 teeth (14 teeth to the inch) for shirt work, beveled for hemmer..
20158	1262	Feed Dog, 17 teeth (16 teeth to the inch) for shirt work.....
20162	1263	Feed Dog, 17 teeth (16 teeth to the inch) for shirt work, beveled for hemmer..
208E	782	Feed Dog Screw.....
20283	1315	" and Feed Lifting Eccentric with 446c
446c	783	" " " " " Set Screw
24036	1340	" " " " " Sleeve.....
20284	1350	" Forked Connection.....
375c	782	" " " Hinge Screw.....
1518E	783	" " " " " Nut
24969	2551	" Lifting Rock Shaft.....
24970	—	Feed Lifting Rock Shaft complete, Nos. 12376 and 24969.....
12376	770	Feed Lifting Rock Shaft Crank with 157J and 1813.....
157J	782	Feed Lifting Rock Shaft Crank Clamping Screw.....
1813	783	Feed Lifting Rock Shaft Crank Roller and Stud.....
43976	2551	Feed Lifting Rock Shaft Crank Connecting Rod with 43977 and two 966E.....
43977	—	Feed Lifting Rock Shaft Crank Connecting Rod Cap.....
966E	5806	Feed Lifting Rock Shaft Crank Connecting Rod Cap Screw.....
375c	782	Feed Lifting Rock Shaft Crank Connecting Rod Hinge Screw.....

From the library of: Dismal Needle Co.

NO.	PLATE	NAME
1518E	783	Feed Lifting Rock Shaft Crank Connecting Rod Hinge Screw Nut
307c	783	Feed Lifting Rock Shaft Screw Centre
56814	—	“ “ “ “ “ “ 307c with 1513J
1513J	783	Feed Lifting Rock Shaft Screw Centre Nut
3039	768	“ Regulator
1128E	2009	“ “ Hinge Screw
818D	783	“ “ Thumb Screw
16506	766	“ Rock Shaft
24376	—	Feed Rock Shaft complete, Nos. 16506 and 29633
29633	1354	Feed Rock Shaft Crank with 157J
157J	782	“ “ “ “ Clamping Screw
307c	783	“ “ “ “ Screw Centre
56814	—	“ “ “ “ “ “ 307c with 1513J
1513J	783	Feed Rock Shaft Screw Centre Nut
12381	767	Needle Bar (hollow)
12382	770	“ “ Connecting Link with 794E
794E	782	“ “ “ “ Adjusting Screw
*12383	—	Needle Bar Connecting Stud
1904	770	“ “ “ “ Roller (roller only)
453c	783	Needle Bar Connecting Stud Set Screw
12384	770	Needle Bar Connecting Stud complete, Nos. 453c, 1904 and 12383
20188	767	Needle Bar Crank with 858c and 1065c
1065c	1366	“ “ “ “ Position Screw
858c	783	“ “ “ “ Set Screw
936E	773	“ “ Screw Bushing
4302	773	“ “ Thread Guard
233D	782	“ “ “ “ Screw
4303	773	“ Clamp with 808F
808F	782	“ “ Screw
24104	1350	Oscillating Rock Shaft
24105	—	Oscillating Rock Shaft complete, Nos. 4784, 12388 and 24104
12388	767	Oscillating Rock Shaft Hinge Pin
878J	783	“ “ “ “ “ Oil Hole Stop Screw
12459	773	Oscillating Rock Shaft Hinge Pin Oil Hole Stop Screw Washer (leather)
448c	783	Oscillating Rock Shaft Hinge Pin Set Screw

NO.	PLATE	NAME
4784	1353	Oscillating Rock Shaft Oil Pad
16509	766	“ Shaft
19496	—	“ “ Crank for 19447
44134	—	“ “ “ “ 44135
19447	1353	Oscillating Shaft Crank complete, Nos. 457c, 1518E, 19449 and 19496
44135	5806	Oscillating Shaft Crank complete, Nos. 1518E, 19449, 44134 and two 453c
2049	773	Oscillating Shaft Crank Pin
457c	783	“ “ “ “ Set Screw for 19447
453c	783	“ “ “ “ “ 44135
19448	1353	“ “ “ “ Slide Block
229D	782	“ “ “ “ “ Cap Screw
12424	773	Oscillating Shaft Crank Slide Block Cap Screw Washer
988c	1353	Oscillating Shaft Crank Slide Block Screw Stud
1518E	783	Oscillating Shaft Crank Slide Block Screw Stud Nut
19449	1353	Oscillating Shaft Crank Slide Block com- plete, Nos. 229D, 988c, 12424 and 19448
12391	767	Presser Bar (hollow)
20059	1341	“ “ Guide Bracket with 453c
453c	783	“ “ “ “ Set Screw
2062	771	“ “ Lifter
689c	782	“ “ “ “ Screw
1529E	783	“ “ “ “ Nut
12327	770	“ “ Lifting and Releasing Lever Bracket
11167	767	Presser Bar Spring (light) .051 wire
NOTE: No. 11167 is sent with this Machine unless another Spring is specified on order.		
12139	2004	Presser Bar Spring (medium) .055 wire
20023	2004	“ “ “ (heavy) .063 wire
11170	771	“ “ “ Washer
12142	780	“ Foot for 12370 and 43979
12143	780	“ “ “ 12369, 12457 and 20106
NOTE: No. 12143 is sent with this Machine unless another Presser Foot is specified on order.		
12258	1308	Presser Foot (wide) for 12369, 12457 and 20106
12335	1308	Presser Foot (narrow) for 12369, 12457 and 20106

NO.	PLATE	NAME
12144	780	Presser Foot for 20117, 20138, 20147, 20151, 20158, 20162, 44144, 44156 and 44177.....
12259	780	Presser Foot for 12425.....
12260	780	" " " 12450, 20147 and 44177.....
12474	1308	" " " 20138 and 20162.....
7298	2014	" " Hinge Pin.....
19334	—	" " Plate.....
19335	—	" " Shank.....
19336	1308	Presser Foot (hinged) complete for 12370 and 43979, Nos. 7298, 19334 and 19335.....
62527	5806	Presser Foot Hinge Pin.....
24544	—	" " Plate.....
24982	—	" " Shank.....
26231	2014	" " Spring.....
24983	781	Presser Foot (spring hinged) complete for 20119, Nos. 24544, 24982, 26231 and 62527.....
7298	2014	Presser Foot Hinge Pin.....
20268	—	" " Plate.....
20269	—	" " Shank.....
20270	1308	Presser Foot (hinged) complete for 12369, 12457 and 20106, Nos. 7298, 20268 and 20269.....
20342	781	Presser Foot for 12450 and 20348.....
20343	781	" " with guide on bottom to the right of needle hole.....
190D	782	Presser Foot Screw.....
688J	783	Pressure Regulating Thumb Screw.....
19131	5737	Shuttle Bobbin.....
20649	5737	" " Case Latch.....
2973	5737	" " " " Lever.....
2974	5737	" " " " Fulcrum Pin.....
2975	5737	Shuttle Bobbin Case Latch Spring.....
592E	5737	" " " " Stop Screw.....
20650	—	Shuttle Bobbin Case Hinge, Nos. 2973, 2974 and 20649.....
20755	5737	Shuttle Bobbin Case Position Finger.....
2523	5737	" " " " " Rivet.....
24323	2046	" " " " Plate.....
391D	1366	" " " " " Screw.....
20756	5737	Shuttle Bobbin Case complete, Nos. 591F, 592E, 2523, 2975, 20650, 20654 and 20755.....

NO.	PLATE	NAME
20757	5737	Shuttle Body.....
591F	5737	" Tension Regulating Screw.....
20654	5737	" " Spring.....
20758	5737	Shuttle, 1 $\frac{1}{8}$ in. diam., Nos. 19131, 20756 and 20757.....
19406	2012	Shuttle Driver with two 1266c.....
2049	773	" " Pin.....
1266c	5806	" " Set Screw.....
2419	2006	" Race Back.....
2532	772	" " " Position Pin.....
2533	767	" " " Spring.....
907D	782	" " " Screw.....
24324	—	" " Body.....
24998	—	" " " 24324 with 24009 and two 1053D.....
24009	2006	Shuttle Race Cap.....
1053D	2006	" " " Screw.....
24325	2046	Shuttle Race complete, Nos. 907D, 2419, 2533, 24323, 24998 and two each 391E and 2532.....
145D	782	Shuttle Race Screw.....
12431	—	" " Slide.....
12432	2004	Shuttle Race Slide complete, Nos. 4307, 12431 and two 725E.....
4307	772	Shuttle Race Slide Spring.....
725E	1387	" " " " Screw.....
20060	1311	Slack Thread Regulator.....
225F	1323	" " " Adjusting Screw.....
2102	5806	Tension Disc.....
1560c	783	" Regulating Thumb Nut.....
32572	5806	" Releasing Disc.....
43944	5806	" " Lever.....
12398	773	" " " Hinge Pin.....
12329	772	" " " Spring.....
32574	5806	" " Pin.....
50327c	5806	" Screw Stud.....
44141	—	" " 50327c with 1560c.....
43945	5806	" Spring.....
44118	—	Tension complete, Nos. 7530, 32572, 32574, 43945, 43946, 44141 and two 2102.....
52454	5842	Thread Retainer.....
50429c	—	" " Set Screw.....
12404	770	" Take-up Crank.....
3094	773	" " " Wedge.....
690E	782	" " " Screw.....
12408	770	" " Lever.....
775E	782	" " " Cap Screw.....

PARTS FOR MACHINE No. 44-13

NO.	PLATE	NAME
12166	773	Thread Take-up Lever Hinge Pin.....
12409	770	" " " Link.....
11204	770	" " " " Hinge Pin...
435c	5806	" " " " " " " Set Screw.....
12410	—	Thread Take-up Lever complete, Nos. 12166, 12408 and 12409.....
43946	5806	Thread Take-up Spring.....
7336	772	" " " Regulator.....
448c	783	" " " " Set Screw.....
12411	776	Throat Plate, large needle hole, for 12369 and 12457.....

NOTE: No. 12411 is sent with this Machine unless another Throat Plate is specified on order.

12449	—	Throat Plate, small needle hole, for 12369 and 12457.....
12412	778	Throat Plate, large needle hole, for 12370 and 43979.....
12466	—	Throat Plate, small needle hole, for 12425
12464	777	" " large needle hole, for 12450 and 20348.....
12451	—	Throat Plate, small needle hole, for 12450 and 20348.....
19497	1261	Throat Plate, large needle hole, for 20117
19405	—	" " small needle hole, for 20117
19409	—	" " large needle hole, for 20138 and 20162.....
19410	1263	Throat Plate, small needle hole, for 20138 and 20162.....
19412	1260	Throat Plate, large needle hole, for 20147 and 44177.....
19413	—	Throat Plate, small needle hole, for 20147 and 44177.....
19415	1262	Throat Plate, large needle hole, for 20151 and 44144.....
19416	—	Throat Plate, small needle hole, for 20151 and 44144.....
19418	1262	Throat Plate, large needle hole, for 20158 and 44156.....
19419	—	Throat Plate, small needle hole, for 20158 and 44156.....
20107	1259	Throat Plate, small needle hole, for 20106

PARTS FOR MACHINE No. 44-13

NO.	PLATE	NAME
20120	1259	Throat Plate, large oblong needle hole, for 20119.....
20187	—	Throat Plate, small oblong needle hole, for 20119.....
691F	782	Throat Plate Screw.....
24079	2644	Drip Pan with four 1 in. wire nails.....

SINGER Needles should be used
in SINGER Machines.
These Needles and their Containers
are marked with the
Company's Trade Mark "SIMANCO. **" 1

Needles in Containers marked
"FOR SINGER MACHINES"
are NOT **SINGER** made needles. 2

LIST OF PARTS COMPLETE FOR



MACHINE No. 44-17

FOR COLLARS AND CUFFS. THROAT PLATE FLUSH
WITH BED. DROP FEED.

NO.	PLATE	NAME
*16501	—	Arm with 11104.....
8582	773	" Dowel Pin.....
12453	773	" Oil Tube, for intermediate bearing..
12454	773	" " " with 29599, for oiling 12409
11119	773	" " " " " " " 12408
24131	2014	" " " " " " " 20283
29599	2014	" " " Packing (felt).....
748E	782	" Screw (back).....
868E	1366	" " (front).....
16511	1349	" Shaft.....
*11104	—	" Bushing (front).....
12357	767	" Flanged Bushing (back).....
448c	783	" " " " " Set Screw.....

PARTS FOR MACHINE No. 44-17

NO.	PLATE	NAME
144D	782	Arm Shaft Screw.....
12480	767	" Side Cap.....
219D	774	" " " Screw.....
12193	2004	" " Cover.....
286D	783	" " " Thumb Screw.....
12403	772	" Spool Pin and Thread Eyelet.....
11241	2003	" " " Washer (cloth).....
24296	1348	Balance Wheel (power) light rim, 2 1/8 in. pulley, with two 448c.....
24297	1340	Balance Wheel Oil Cover.....
210D	1343	" " " Screw.....
448c	783	" " Set Screw.....
*16503	—	Bed.....
20197	1350	Crank Connecting Rod with 20198 and two 896E.....
*20198	—	Crank Connecting Rod Cap.....
896E	773	" " " " Screw.....
908c	773	" " " " Hinge Screw.....
1619E	773	" " " " " Nut..
20057	—	Face Plate.....
20058	1340	Face Plate complete, Nos. 2827, 12150 and 20057.....
190D	782	Face Plate Screw.....
44181	—	Face Plate Thread Guard (lower).....
12150	773	" " " " " " 44181 with 12152.....
12152	773	Face Plate Thread Guard (lower) Rivet...
2827	773	" " " " (upper) with 8505
8505	773	" " " " " Rivet....
286D	783	" " Thumb Screw.....
12368	767	Feed Bar.....
313c	783	" " Screw Centre.....
56813	—	" " " " 313c with 1519r..
1519r	783	" " " " " Nut.....
3033	770	" Connecting Link.....
375c	782	" " " Hinge Screw.....
1518E	783	" " " " " Nut..
12460	775	" Dog.....

NOTE: No. 12460 is sent with this Machine unless
another Feed Dog is specified on order.

19488	775	Feed Dog.....
20041	1266	" " ".....
208E	782	" " Screw.....
20283	1315	" and Feed Lifting Eccentric with 446c
446c	783	" " " " " Set Screw
24036	1340	" " " " " Sleeve...

NO.	PLATE	NAME
20284	1350	Feed Forked Connection.....
375c	782	" " " Hinge Screw....
1518E	783	" " " " " Nut
24969	2551	" Lifting Rock Shaft.....
24970	—	Feed Lifting Rock Shaft complete, Nos. 12376 and 24969.....
12376	770	Feed Lifting Rock Shaft Crank with 157J and 1813.....
157J	782	Feed Lifting Rock Shaft Crank Clamping Screw.....
1813	783	Feed Lifting Rock Shaft Crank Roller and Stud.....
43976	2551	Feed Lifting Rock Shaft Crank Connect- ing Rod with 43977 and two 966E....
*43977	—	Feed Lifting Rock Shaft Crank Connect- ing Rod Cap.....
966E	5806	Feed Lifting Rock Shaft Crank Connect- ing Rod Cap Screw.....
375c	782	Feed Lifting Rock Shaft Crank Connect- ing Rod Hinge Screw.....
1518E	783	Feed Lifting Rock Shaft Crank Connect- ing Rod Hinge Screw Nut.....
307c	783	Feed Lifting Rock Shaft Screw Centre....
56814	—	" " " " " 307c with 1513J.....
1513J	783	Feed Lifting Rock Shaft Screw Centre Nut
3039	768	" Regulator.....
1128E	2009	" " Hinge Screw.....
818D	783	" " Thumb Screw.....
24585	8375	" " " " Stop.....
16506	766	" Rock Shaft.....
24376	—	Feed Rock Shaft complete, Nos. 16506 and 29633.....
29633	1354	Feed Rock Shaft Crank with 157J.....
157J	782	" " " " Clamping Screw
307c	783	" " " Screw Centre.....
56814	—	" " " " " 307c with 1513J.....
1513J	783	Feed Rock Shaft Screw Centre Nut.....
12381	767	Needle Bar (hollow).....
12382	770	" " Connecting Link with 794E..
794E	782	" " " " Adjusting Screw.....
*12383	—	Needle Bar Connecting Stud.....
1904	770	" " " " Roller (roller only).....

NO.	PLATE	NAME
453c	783	Needle Bar Connecting Stud Set Screw..
12384	770	Needle Bar Connecting Stud complete, Nos. 453c, 1904 and 12383.....
20188	767	Needle Bar Crank with 858c and 1065c..
1065c	1366	" " " Position Screw.....
858c	783	" " " Set Screw.....
936E	773	" " Screw Bushing.....
4302	773	" " Thread Guard.....
233D	782	" " " " Screw.....
4303	773	" Clamp with 808F.....
808F	782	" " Screw.....
24104	1350	Oscillating Rock Shaft.....
24105	—	Oscillating Rock Shaft complete, Nos. 4784, 12388 and 24104.....
12388	767	Oscillating Rock Shaft Hinge Pin.....
878J	783	" " " " " Oil Hole Stop Screw.....
12459	773	Oscillating Rock Shaft Hinge Pin Oil Hole Stop Screw Washer (leather).....
448c	783	Oscillating Rock Shaft Hinge Pin Set Screw.....
4784	1353	Oscillating Rock Shaft Oil Pad.....
16509	766	" Shaft.....
19496	—	" " Crank for 19447.....
44134	—	" " " " 44135.....
19447	1353	Oscillating Shaft Crank complete, Nos. 457c, 1518E, 19449 and 19496.....
44135	5806	Oscillating Shaft Crank complete, Nos. 1518E, 19449, 44134 and two 453c....
2049	773	Oscillating Shaft Crank Pin.....
457c	783	" " " Set Screw for 19447
453c	783	" " " " " " 44135
19448	1353	" " " Slide Block.....
229D	782	" " " " " Cap Screw.....
12424	773	Oscillating Shaft Crank Slide Block Cap Screw Washer.....
988c	1353	Oscillating Shaft Crank Slide Block Screw Stud.....
1518E	783	Oscillating Shaft Crank Slide Block Screw Stud Nut.....
19449	1353	Oscillating Shaft Crank Slide Block com- plete, Nos. 229D, 988c, 12424 and 19448

NO.	PLATE	NAME
12391	767	Presser Bar (hollow).....
20059	1341	" " Guide Bracket with 453c....
453c	783	" " " " Set Screw....
2062	771	" " Lifter.....
689c	782	" " " Screw.....
1520E	783	" " " " Nut.....
12327	770	" " Lifting and Releasing Lever Bracket.....
11167	767	Presser Bar Spring (light) .051 wire.....
NOTE: No. 11167 is sent with this Machine unless another Spring is specified on order.		
12139	2004	Presser Bar Spring (medium) .055 wire..
20023	2004	" " " (heavy) .063 wire....
11170	771	" " " Washer.....
12435	780	" Foot with 228D, for 12460, 19488, 20041 and 25967.....
NOTE: No. 12435 is sent with this Machine unless another Presser Foot is specified on order.		
12462	781	Presser Foot, $\frac{1}{8}$ in. to $\frac{1}{4}$ in. gauge.....
NOTE: When ordering No. 12462, give width of turned edge from seam.		
12463	781	Presser Foot with Strip Guide.....
26276	1394	" " Hinge Pin.....
20133	—	" " Plate.....
19223	—	" " Shank.....
20134	1308	Presser Foot (hinged) complete, $\frac{1}{8}$ in. to $\frac{1}{4}$ in. gauge, Nos. 19223, 20133 and 26276.....
NOTE: When ordering No. 20134, give width of turned edge from seam.		
2532	772	Presser Foot Hinge Pin.....
20155	—	" " Plate.....
20156	—	" " Shank.....
20157	1309	Presser Foot (hinged) complete for 12460, 19488, 20041 and 25967, Nos. 228D, 2532, 20155 and 20156.....
26276	1394	Presser Foot Hinge Pin.....
20360	—	" " Plate.....
19335	—	" " Shank.....
20361	781	Presser Foot (hinged) plain bottom, com- plete, Nos. 19335, 20360 and 26276....
26279	—	Presser Foot Extension, $\frac{1}{8}$ in., for 12435 and 20157.....

NO.	PLATE	NAME
26280	—	Presser Foot Extension, $\frac{1}{8}$ in., for 12435 and 20157.....
26281	1387	Presser Foot Extension, $\frac{1}{4}$ in., for 12435 and 20157.....
26282	—	Presser Foot Extension, $\frac{3}{8}$ in., for 12435 and 20157.....
26283	—	Presser Foot Extension, $\frac{1}{2}$ in., for 12435 and 20157.....
228D	2038	Presser Foot Extension Screw.....
190D	782	" " Screw.....
25967	1387	" " Strip Gauge.....
228D	2038	" " " " Screw.....
NOTE: Nos. 25967 and 26279 to 26283 are sent with this Machine unless otherwise specified on order		
688J	783	Pressure Regulating Thumb Screw.....
19131	5737	Shuttle Bobbin.....
20649	5737	" " Case Latch.....
2973	5737	" " " " Lever.....
2974	5737	" " " " " Fulcrum Pin.....
2975	5737	Shuttle Bobbin Case Latch Spring.....
592E	5737	" " " " Stop Screw.....
20650	—	Shuttle Bobbin Case Hinge, Nos. 2973 2974 and 20649.....
20755	5737	Shuttle Bobbin Case Position Finger.....
2523	5737	" " " " " Rivet.....
24323	2046	" " " " Plate.....
391D	1366	" " " " " Screw.....
20756	5737	Shuttle Bobbin Case complete, Nos. 591E 592E, 2523, 2975, 20650, 20654 and 20755.....
20757	5737	Shuttle Body.....
591F	5737	" Tension Regulating Screw.....
20654	5737	" " Spring.....
20758	5737	Shuttle, 1 $\frac{1}{8}$ in. diam., Nos. 19131, 20756 and 20757.....
19406	2012	Shuttle Driver with two 1266c.....
2049	773	" " Pin.....
1266c	5806	" " Set Screw.....
2419	2006	" Race Back.....
2532	772	" " " Position Pin.....
2533	767	" " " Spring.....
907D	782	" " " " Screw.....
24326	—	" " Body.....
62513	—	" " " 24326 with 24009 and two 1053D.....

NO.	PLATE	NAME
62522	—	Shuttle Race Body 62513 with two 2532
24009	2006	“ “ Cap.....
1053D	2006	“ “ Screw.....
24327	1359	Shuttle Race complete, Nos. 907D, 2419, 2533, 24323, 62522 and two 391D.....
145D	782	Shuttle Race Screw.....
12431	—	“ “ Slide.....
12432	2004	Shuttle Race Slide complete, Nos. 4307, 12431 and two 725E.....
4307	772	Shuttle Race Slide Spring.....
725E	1387	“ “ “ “ Screw.....
20060	1311	Slack Thread Regulator.....
225F	1323	“ “ “ “ Adjusting Screw.....
2102	5806	Tension Disc.....
1560C	783	“ Regulating Thumb Nut.....
32572	5806	“ Releasing Disc.....
43944	5806	“ “ Lever.....
12398	773	“ “ “ Hinge Pin.....
12329	772	“ “ “ Spring.....
32574	5806	“ “ Pin.....
50327C	5806	“ Screw Stud.....
44141	—	“ “ “ 50327C with 1560C.....
43945	5806	“ Spring.....
44118	—	Tension complete, Nos. 7336, 32572, 32574, 43945, 43946, 44141 and two 2102.....
52454	5842	Thread Retainer.....
50429C	—	“ “ Set Screw.....
12404	770	“ Take-up Crank.....
3094	773	“ “ “ Wedge.....
690E	782	“ “ “ “ Screw.....
12408	770	“ “ Lever.....
775E	782	“ “ “ Cap Screw.....
12166	773	“ “ “ Hinge Pin.....
12409	770	“ “ “ Link.....
11204	770	“ “ “ “ Hinge Pin.....
435C	5806	“ “ “ “ “ “ Set Screw.....
12410	—	Thread Take-up Lever complete, Nos. 12166, 12408 and 12409.....
43946	5806	Thread Take-up Spring.....
7336	772	“ “ “ Regulator.....
448C	783	“ “ “ “ Set Screw.....
12434	775	Throat Plate, small needle hole, for 19488

NOTE: Two No. 12434 are sent with this Machine unless other Throat Plates are specified on order.

NO.	PLATE	NAME
20042	1266	Throat Plate, large needle hole, for 20041
20043	—	“ “ small needle hole, for 20041
12461	775	“ “ “ “ “ 12460
691F	782	“ “ Screw.....
24079	2644	Drip Pan with four 1 in. wire nails.....

SPOOL HOLDER (Disc)

26763	1352	Bracket with 219F and 287D.....
219F	774	“ Screw.....
287D	2636	“ Thumb Screw.....
19066	1352	Spindle.....
19067	1352	“ Thread Guiding Disc.....
691F	782	“ “ “ “ Screw.....
26764	1352	Spool Holder (disc) complete, Nos. 691F, 19066, 19067 and 26763.....

LIST OF PARTS COMPLETE

FOR

MACHINE No. 44-20

FOR LIGHT WORK ONLY, WITH SHORT STITCH, IN CLOTH.
DROP FEED.

NO.	PLATE	NAME
*24025	—	Arm with 11104.....
8582	773	" Dowel Pin.....
12453	773	" Oil Tube, for intermediate bearing..
12454	773	" " " with 29599, for oiling 24099
11119	773	" " " " " " " 24068
24131	2014	" " " " " " " 24035
29599	2014	" " " Packing (felt).....
748E	782	" Screw (back).....
868E	1366	" " (front).....
24026	1339	" Shaft.....
*11104	—	" " Bushing (front).....
12357	767	" " Flanged Bushing (back).....
448C	783	" " " " " Set Screw.....
144D	782	Arm Shaft Screw.....
12480	767	" Side Cap.....
219D	774	" " " Screw.....
12193	2004	" " Cover.....
286D	783	" " " Thumb Screw.....
12403	772	" Spool Pin and Thread Eyelet.....
11241	2003	" " " Washer (cloth).....
24328	1339	Balance Wheel, light rim, 2 1/4 in. pulley, with two 448c.....
24297	1340	Balance Wheel Oil Cover.....
210D	1343	" " " " Screw.....
448C	783	" " " Set Screw.....
*24027	—	Bed.....
24028	1339	Crank Connecting Rod with 24085 and two 896E.....
*24085	—	Crank Connecting Rod Cap.....
896E	773	" " " " " Screw.....
908C	773	" " " " " Hinge Screw.....
1619E	773	" " " " " " Nut
20057	—	Face Plate.....

NO.	PLATE	NAME
20058	1340	Face Plate complete, Nos. 2827, 12150 and 20057.....
190D	782	Face Plate Screw.....
44181	—	" " Thread Guard (lower).....
12150	773	" " " " " " 44181 with 12152.....
12152	773	Face Plate Thread Guard (lower) Rivet...
2827	773	" " " " (upper) with 8505
8505	773	" " " " " Rivet....
286D	783	" " Thumb Screw.....
24034	1340	Feed Bar.....
313c	783	" " Screw Centre.....
56813	—	" " " " " 313c with 1519r..
1519r	783	" " " " " Nut.....
3033	770	" Connecting Link.....
375c	782	" " " " " Hinge Screw.....
1518E	783	" " " " " " Nut
12450	777	" Dog, for cloth, 11 teeth (18 teeth to the inch).....

NOTE: No. 12450 is sent with this Machine unless
another Feed Dog is specified on order.

20348	777	Feed Dog, 22 teeth (36 teeth to the inch for chiffon).....
20142	1260	Feed Dog, 13 teeth (16 teeth to the inch) for general work.....
20147	1260	Feed Dog, 12 teeth (14 teeth to the inch)
62529	1260	" " 18 teeth (22 teeth to the inch) for general work.....
20151	1262	Feed Dog, 13 teeth (14 teeth to the inch) for shirt work, beveled for hemmer....
44144	1262	Feed Dog, 22 teeth (24 teeth to the inch) beveled for hemmer.....
20159	1261	Feed Dog, for shirt work.....
20117	1261	" " 16 teeth (16 teeth to the inch) for shirt work, beveled for hemmer....
20132	1261	Feed Dog, 22 teeth (22 teeth to the inch) for shirt work, beveled for hemmer....
20138	1263	Feed Dog, 13 teeth (12 teeth to the inch) for shirt work, beveled for hemmer....
20162	1263	Feed Dog, 17 teeth (16 teeth to the inch) for shirt work, beveled for hemmer....
12369	776	Feed Dog, 12 teeth (12 teeth to the inch)
12457	776	" " 16 teeth (16 teeth to the inch)
20325	1264	" " 18 teeth (16 teeth to the inch) for shirt work.....

NO.	PLATE	NAME
20468	8375	Feed Dog, for tucking
44177	1260	" " 19 teeth (22 teeth to the inch)
208E	782	" " Screw
24035	1340	" and Feed Lifting Eccentric with 448c
448c	783	" " " " " Set Screw
24036	1340	" " " " " Sleeve
24037	1339	" Forked Connection
375c	782	" " " Hinge Screw
1518E	783	" " " " " Nut
16504	766	" Lifting Rock Shaft
16588	—	Feed Lifting Rock Shaft complete, Nos. 2049, 12376, 16504 and 16556
16556	2009	Feed Lifting Rock Shaft Crank (back) with 462c
2049	773	Feed Lifting Rock Shaft Crank (back) Pin
462c	773	Feed Lifting Rock Shaft Crank (back) Set Screw
12376	770	Feed Lifting Rock Shaft Crank (front) with 157J and 1813
157J	782	Feed Lifting Rock Shaft Crank (front) Clamping Screw
1813	783	Feed Lifting Rock Shaft Crank (front) Roller and Stud
12430	5764	Feed Lifting Rock Shaft Crank Connect- ing Rod with 12204 and two 966E
*12204	—	Feed Lifting Rock Shaft Crank Connect- ing Rod Cap
966E	5806	Feed Lifting Rock Shaft Crank Connect- ing Rod Cap Screw
375c	782	Feed Lifting Rock Shaft Crank Connect- ing Rod Hinge Screw
1518E	783	Feed Lifting Rock Shaft Crank Connect- ing Rod Hinge Screw Nut
307c	783	Feed Lifting Rock Shaft Screw Centre
56814	—	" " " " " " 307c with 1513J
1513J	783	Feed Lifting Rock Shaft Screw Centre Nut
3039	768	" Regulator
1128E	2009	" " Hinge Screw
818D	783	" " Thumb Screw
16506	766	" Rock Shaft
24376	—	Feed Rock Shaft complete, Nos. 16506 and 29633

NO.	PLATE	NAME
29633	1354	Feed Rock Shaft Crank with 157J
157J	782	" " " " Clamping Screw
307c	783	" " " " Screw Centre
56814	—	" " " " " " 307c with 1513J
1513J	783	Feed Rock Shaft Screw Centre Nut
24451	2647	Needle Bar
24442	2647	" " Bushing with 29532
1133E	8376	" " " Set Screw
24040	1341	" " Connecting Link with 794E
794E	782	" " " " Adjusting Screw
775E	782	Needle Bar Connecting Link Cap Screw
24041	1341	" " " Stud with 207E
207E	1341	" " " " Clamping Screw
24052	1340	Needle Bar Crank with 878c, 1036c, 1065c and 1065c
1065c	1366	Needle Bar Crank Position Screw
858c	783	" " " Set Screw
862D	1341	" " Hole Plug Screw
29532	1341	" " Oil Cup
24452	2647	" " Gib
24453	2647	" Clamp with 196F and 24452
196F	772	" " Screw
24043	1340	Oscillating Rock Shaft
24044	—	Oscillating Rock Shaft complete, Nos. 4784, 12388 and 24043
12388	767	Oscillating Rock Shaft Hinge Pin
878J	783	" " " " Oil Hole Stop Screw
12459	773	Oscillating Rock Shaft Hinge Pin Oil Hole Stop Screw Washer (leather)
448c	783	Oscillating Rock Shaft Hinge Pin Set Screw
4784	1353	Oscillating Rock Shaft Oil Pad
24045	1339	" Shaft
24046	1341	" " Bushing (back)
24047	1341	" " " (front)
24048	—	" " Crank
24049	1343	Oscillating Shaft Crank complete, Nos. 462c, 1636E, 24048 and 24050
2269	773	Oscillating Shaft Crank Pin
462c	773	" " " Set Screw
19448	1353	" " " Slide Block
229D	782	" " " " Cap Screw

NO.	PLATE	NAME
12424	773	Oscillating Shaft Crank Slide Block Cap Screw Washer.....
1035c	1343	Oscillating Shaft Crank Slide Block Screw Stud.....
1636E	1343	Oscillating Shaft Crank Slide Block Screw Stud Nut.....
24050	1343	Oscillating Shaft Crank Slide Block complete, Nos. 229D, 1035c, 12424 and 19448.....
12391	767	Presser Bar (hollow).....
20059	1341	" " Guide Bracket with 453c.....
453c	783	" " " " Set Screw.....
2062	771	" " Lifter.....
689c	782	" " " " Screw.....
1520E	783	" " " " Nut.....
12327	770	" " Lifting and Releasing Lever Bracket.....
11167	767	Presser Bar Spring (light) .051 wire.....
NOTE: No. 11167 is sent with this Machine unless another Spring is specified on order.		
12139	2004	Presser Bar Spring (medium) .055 wire.....
20023	2004	" " " (heavy) .063 wire.....
11170	771	" " " Washer.....
12143	780	" Foot for 12369 and 12457.....
12144	780	" " " 20117, 20132, 20138, 20151, 20159, 20162 and 44144.....
12260	780	Presser Foot for 12450, 20147, 20348 and 44177.....
2532	772	Presser Foot Hinge Pin.....
20344	—	" " Plate.....
20345	—	" " Shank.....
26231	1353	" " Spring.....
20346	781	Presser Foot (spring hinged) complete, Nos. 2532, 20344, 20345 and 26231.....
7298	2014	Presser Foot Hinge Pin.....
20268	—	" " Plate.....
20269	—	" " Shank.....
20270	1308	Presser Foot (hinged) complete for 12369 and 12457, Nos. 7298, 20268 and 20269.....
20118	1308	Presser Foot, for general work, for 12450.....
NOTE: No. 20118 is sent with this Machine unless another Presser Foot is specified on order.		
2532	772	Presser Foot Hinge Pin.....
20472	—	" " Plate.....
20473	—	" " Shank.....
26231	1353	" " Spring.....

NO.	PLATE	NAME
20474	8375	Presser Foot (spring hinged) complete, for fine silk, etc., Nos. 2532, 20472, 20473 and 26231.....
20150	1308	Presser Foot for 20142 and 62529.....
20342	781	" " " 12450 and 20348.....
190D	782	" " " Screw.....
688J	783	Pressure Regulating Thumb Screw.....
24051	1343	Shuttle Bobbin.....
15140	1353	" " Case Latch.....
2973	771	" " " " Lever.....
2974	771	" " " " " Fulcrum Pin.....
2975	771	Shuttle Bobbin Case Latch Spring.....
592E	782	" " " " Stop Screw.....
15141	—	Shuttle Bobbin Case Hinge, Nos. 2973, 2974 and 15140.....
24055	1343	Shuttle Bobbin Case Position Finger.....
2523	771	" " " " " Retentive Plate.....
24412	1391	" " " " " Screw.....
391D	1366	" " " " " Screw.....
24056	1343	Shuttle Bobbin Case complete, Nos. 591E, 592E, 2523, 2975, 15141, 24055 and 24058.....
24057	1343	Shuttle Body.....
591E	782	" Tension Regulating Screw.....
24058	1343	" " Spring.....
24059	1343	Shuttle, 1 1/8 in. diam., Nos. 24051, 24056 and 24057.....
*24060	—	Shuttle Driver.....
24061	1343	" " 24060 with two 462c.....
2269	773	" " Pin.....
462c	773	" " Set Screw.....
24062	1342	" Race Back.....
2532	772	" " " Position Pin.....
2533	767	" " " Spring.....
907D	782	" " " " Screw.....
24437	—	" " Body.....
62510	—	" " " 24437 with 24064 and two 1053D.....
62519	—	Shuttle Race Body 62510 with two 2532.....
24064	1342	" " Cap.....
1053D	2006	" " " Screw.....
24438	1364	Shuttle Race complete, Nos. 907D, 2533, 24062, 24412, 62519 and two 391D.....
145D	782	Shuttle Race Screw.....
12431	—	" " Slide.....

NO.	PLATE	NAME
12432	2004	Shuttle Race Slide complete, Nos. 4307, 12431 and two 725E.....
4307	772	Shuttle Race Slide Spring.....
725E	1387	" " " " Screw.....
20060	1311	Slack Thread Regulator.....
225F	1323	" " " Adjusting Screw.....
2102	5806	Tension Disc.....
1560c	783	" Regulating Thumb Nut.....
32572	5806	" Releasing Disc.....
43944	5806	" " Lever.....
12398	773	" " " Hinge Pin.....
12329	772	" " " Spring.....
32574	5806	" " Pin.....
50327c	5806	" Screw Stud.....
44141	—	" " " 50327c with 1560c.....
8238	1353	" Spring.....
24984	—	Tension complete, Nos. 7336, 8238, 24071, 32572, 32574, 44141 and two 2102.....
24078	1343	Thread Guard (side of arm).....
52454	5842	" Retainer.....
50429c	—	" " Set Screw.....
24097	1341	" Take-up Crank.....
1037c	1341	" " " Position Screw.....
1036c	1341	" " " Set Screw.....
24068	1341	" " Lever.....
12166	773	" " " Hinge Pin.....
24099	1341	" " " Link.....
11204	770	" " " " Hinge Pin.....
435c	5806	" " " " " " " Set Screw.....
24070	—	Thread Take-up Lever complete, Nos. 12166, 24068 and 24099.....
24071	1343	Thread Take-up Spring.....
7336	772	" " " Regulator.....
448c	783	" " " " Set Screw.....
20135	1264	Throat Plate, large needle hole, for 12450 and 20348.....
20136	—	Throat Plate, small needle hole, for 12450 and 20348.....
NOTE: No. 20136 is sent with this Machine unless another Throat Plate is specified on order.		
20124	1261	Throat Plate, large needle hole, for 20117 and 20132.....
20125	—	Throat Plate, small needle hole, for 20117 and 20132.....

NO.	PLATE	NAME
20139	1263	Throat Plate, large needle hole, for 20138 and 20162.....
20140	—	Throat Plate, small needle hole, for 20138 and 20162.....
20143	1260	Throat Plate, large needle hole, for 20142 and 62529.....
20144	—	Throat Plate, small needle hole, for 20142 and 62529.....
20148	1260	Throat Plate, large needle hole, for 20147 and 44177.....
20149	—	Throat Plate, small needle hole, for 20147 and 44177.....
20152	1262	Throat Plate, large needle hole, for 20151 and 44144.....
20153	—	Throat Plate, small needle hole, for 20151 and 44144.....
20160	1261	Throat Plate, large needle hole, for 20159.....
20161	—	" " small needle hole, for 20159.....
20190	1263	" " large needle hole, for 12369 and 12457.....
20191	—	Throat Plate, small needle hole, for 12369 and 12457.....
20326	1264	Throat Plate, large needle hole, for 20325.....
20327	—	" " small needle hole, for 20325.....
20469	8375	" " large needle hole, for 20468.....
20470	—	" " small needle hole, for 20468.....
691F	782	" " Screw.....
24079	2644	Drip Pan with four 1 in. wire nails.....

SINGER Needles should be used
in SINGER Machines.
These Needles and their Containers
are marked with the
Company's Trade Mark "SIMANCO.™" 1

Needles in Containers marked
"FOR SINGER MACHINES"
are NOT **SINGER** made needles. 2

**LIST OF PARTS COMPLETE
FOR
MACHINE No. 44-22**

**FOR RUFFLING AND STITCHING THICK OR THIN FABRICS,
APRONS, DRESSES, INFANTS' GARMENTS, SKIRTS, ETC.
ONE NEEDLE, POSITIVE RUFFLING MECHANISM, DROP
FEED.**

NO.	PLATE	NAME
*24302	—	Arm with 11104.....
8582	773	" Dowel Pin.....
12453	773	" Oil Tube, for intermediate bearing..
12454	773	" " " with 29599, for oiling 12400
11119	773	" " " " " " " " 12408 and 24207.....
24131	2014	Arm Oil Tube with 29599, for oiling 20283
29599	2014	" " " Packing (felt).....
748E	782	" Screw (back).....
868E	1366	" " (front).....
24195	1349	" Shaft.....
*11104	—	" " Bushing (front).....
12357	767	" " Flanged Bushing (back).....
448c	783	" " " " " " " " S e t Screw.....
144D	782	Arm Shaft Screw.....
12480	767	" Side Cap.....
219D	774	" " " Screw.....
12193	2004	" " Cover.....
286D	783	" " " Thumb Screw.....
12403	772	" Spool Pin and Thread Eyelet.....
11241	2003	" " " Washer (cloth).....
24296	1348	Balance Wheel (power) light rim, 2 1/8 in. pulley, with two 448c.....
24297	1340	Balance Wheel Oil Cover.....
210D	1343	" " " " Screw.....
448c	783	" " " Set Screw.....
*16503	—	Bed.....
20197	1350	Crank Connecting Rod with 20198 and two 896E.....
*20198	—	Crank Connecting Rod Cap.....
896E	773	" " " " Screw.....
908c	773	" " " " Hinge Screw.....
1619E	773	" " " " " " Nut

NO.	PLATE	NAME
20057	—	Face Plate.....
20058	1340	Face Plate complete, Nos. 2827, 12150 and 20057.....
190D	782	Face Plate Screw.....
44181	—	" " Thread Guard (lower).....
12150	773	" " " " " " 44181 with 12152.....
12152	773	Face Plate Thread Guard (lower) Rivet ..
2827	773	" " " " (upper) with 8505
8505	773	" " " " " Rivet ..
286D	783	" " Thumb Screw.....
12368	767	Feed Bar.....
313c	783	" " Screw Centre.....
56813	—	" " " " 313c with 1519J..
1519J	783	" " " " Nut.....
3033	770	" Connecting Link.....
375c	782	" " " Hinge Screw.....
1518E	783	" " " " " Nut..
24303	1344	" Dog.....
208E	782	" " Screw.....
20283	1315	" and Feed Lifting Eccentric with 446c
446c	783	" " " " " Set Screw
24036	1340	" " " " " Sleeve...
20284	1350	" Forked Connection.....
375c	782	" " " Hinge Screw....
1518E	783	" " " " " Nut
24969	2551	" Lifting Rock Shaft.....
24970	—	Feed Lifting Rock Shaft complete, Nos. 12376 and 24969.....
12376	770	Feed Lifting Rock Shaft Crank with 157J and 1813.....
157J	782	Feed Lifting Rock Shaft Crank Clamping Screw.....
1813	783	Feed Lifting Rock Shaft Crank Roller and Stud.....
43976	2551	Feed Lifting Rock Shaft Crank Connect- ing Rod with 43977 and two 966E....
*43977	—	Feed Lifting Rock Shaft Crank Connect- ing Rod Cap.....
966E	5806	Feed Lifting Rock Shaft Crank Connect- ing Rod Cap Screw.....
375c	782	Feed Lifting Rock Shaft Crank Connect- ing Rod Hinge Screw.....
1518E	783	Feed Lifting Rock Shaft Crank Connect- ing Rod Hinge Screw Nut.....

NO.	PLATE	NAME
307c	783	Feed Lifting Rock Shaft Screw Centre...
56814	—	“ “ “ “ “ “ 307c with 1513J.....
1513J	783	Feed Lifting Rock Shaft Screw Centre Nut
3039	768	“ Regulator.....
1128E	2009	“ “ Hinge Screw.....
818D	783	“ “ Thumb Screw.....
16506	766	“ Rock Shaft.....
24376	—	Feed Rock Shaft complete, Nos. 16506 and 29633.....
29633	1354	Feed Rock Shaft Crank with 157J.....
157J	782	“ “ “ “ Clamping Screw.
307c	783	“ “ “ Screw Centre.....
56814	—	“ “ “ “ “ “ 307c with 1513J.....
1513J	783	Feed Rock Shaft Screw Centre Nut.....
12381	767	Needle Bar (hollow).....
12382	770	“ “ Connecting Link with 794E...
794E	782	“ “ “ “ Adjusting Screw.....
*12383	—	Needle Bar Connecting Stud.....
1904	770	“ “ “ “ Roller (roller only).....
453c	783	Needle Bar Connecting Stud Set Screw...
12384	770	Needle Bar Connecting Stud complete, Nos. 453c, 1904 and 12383.....
20188	767	Needle Bar Crank with 858c and 1065c...
1065c	1366	“ “ “ Position Screw.....
858c	783	“ “ “ Set Screw.....
936E	773	“ “ Screw Bushing.....
4302	773	“ “ Thread Guard.....
233D	782	“ “ “ “ Screw.....
4303	773	“ Clamp with 808F.....
808F	782	“ “ Screw.....
24104	1350	Oscillating Rock Shaft.....
24105	—	Oscillating Rock Shaft complete, Nos. 4784, 12388 and 24104.....
12388	767	Oscillating Rock Shaft Hinge Pin.....
878J	783	“ “ “ “ “ Oil Hole Stop Screw.....
12459	773	Oscillating Rock Shaft Hinge Pin Oil Hole Stop Screw Washer (leather).....
448c	783	Oscillating Rock Shaft Hinge Pin Set Screw.....

NO.	PLATE	NAME
4784	1353	Oscillating Rock Shaft Oil Pad.....
16509	766	“ Shaft.....
19496	—	“ “ Crank for 19447.....
44134	—	“ “ “ “ 44135.....
19447	1353	Oscillating Shaft Crank complete, Nos. 457c, 1518E, 19449 and 19496.....
44135	5806	Oscillating Shaft Crank complete, Nos. 1518E, 19449, 44134 and two 453c.....
2049	773	Oscillating Shaft Crank Pin.....
457c	783	“ “ “ Set Screw for 19447
453c	783	“ “ “ “ “ “ 44135
19448	1253	“ “ “ Slide Block.....
229D	782	“ “ “ “ “ Cap Screw.....
12424	773	Oscillating Shaft Crank Slide Block Cap Screw Washer.....
988c	1353	Oscillating Shaft Crank Slide Block Screw Stud.....
1518E	783	Oscillating Shaft Crank Slide Block Screw Stud Nut.....
19449	1353	Oscillating Shaft Crank Slide Block com- plete, Nos. 229D, 988c, 12424 and 19448
12391	767	Presser Bar (hollow).....
20059	1341	“ “ Guide Bracket with 453c.....
453c	783	“ “ “ “ Set Screw.....
2062	771	“ “ Lifter.....
689c	782	“ “ “ Screw.....
1520E	783	“ “ “ “ Nut.....
12327	770	“ “ Lifting and Releasing Lever Bracket.....
11167	767	Presser Bar Spring (light) .051 wire.....
NOTE: No. 11167 is sent with this Machine unless another Spring is specified on order.		
12139	2004	Presser Bar Spring (medium) .055 wire...
20023	2004	“ “ “ (heavy) .063 wire.....
11170	771	“ “ “ Washer.....
24304	1344	“ Foot.....
190D	782	“ “ Screw.....
688J	783	Pressure Regulating Thumb Screw.....
26888	1344	Ruffling Arm (lower).....
26889	1344	“ “ (upper) with 190D and 219F
207F	1344	“ “ Adjusting Screw.....
2291	1344	“ “ “ “ Washer...
190D	782	“ “ Clamping Screw.....
26890	1344	Ruffling Arm (adjustable) Nos. 2291, 26888, 26889 and two 207F.....

NO.	PLATE	NAME
28845	—	Ruffling Arm (adjustable) complete, Nos. 226D, 1550J, 24203 to 24206, 26890 and two 665D
24199	1323	Ruffling Arm Shaft
24200	1324	" " " Bracket (right)
145D	1324	" " " " " Screw
24201	1324	" " " " (left)
159D	1324	" " " " " Screw
6533	1323	" " " Collar with 460C
460C	1323	" " " Set Screw
219F	774	" " Set Screw
24305	1344	" Blade
24203	1344	" " Holder
226D	1344	" " " Cap Screw
24204	1344	" " " Spring
24205	1344	" " " " Stop
24206	1344	" " " Stud
1550J	1344	" " " " Nut
665D	1344	" " " Screw
24207	1323	" Eccentric with two 453C
24208	1323	" " Collar with 453C
453C	1323	" " " Set Screw
24219	1323	" " Connection with 24220 and two 742E
24220	—	Ruffling Eccentric Connection Cap
742E	1323	" " " " Screw
24210	1324	" " " Washer
453C	1323	" " Set Screw
24211	1323	" Regulator with 225F
225F	1323	" " Set Screw
181D	1323	" " Stop Screw
1641E	1323	" " " " Nut
1108F	1323	" " Thumb Screw
1641E	1323	" " " " Nut
24718	1352	" Separating Blade
4604	1385	" " " Rivet
43919	1352	" " " Shank
24410	1352	Ruffling Separating Blade on Shank complete, Nos. 24718, 43919 and two 4604
1423D	5742	Ruffling Separating Blade Screw
19131	5737	Shuttle Bobbin
20649	5737	" " Case Latch
2973	5737	" " " " Lever
2974	5737	" " " " " Fulerum Pin
2975	5737	Shuttle Bobbin Case Latch Spring
592E	5737	" " " " Stop Screw

NO.	PLATE	NAME
20650	—	Shuttle Bobbin Case Hinge, Nos. 2973, 2974 and 20649
20755	5737	Shuttle Bobbin Case Position Finger
2523	5737	" " " " " Rivet
24323	2046	" " " " " Plate
391D	1366	" " " " " Screw
20756	5737	Shuttle Bobbin Case complete, Nos. 591E, 592E, 2523, 2975, 20650, 20654 and 20755
20757	5737	Shuttle Body
591F	5737	" Tension Regulating Screw
20654	5737	" " Spring
20758	5737	Shuttle, 1 1/8 in. diam., Nos. 19131, 20756 and 20757
19106	2012	Shuttle Driver with two 1236C
2049	773	" " Pin
1266C	5806	" " Set Screw
2419	2006	" Race Back
2532	772	" " " Position Pin
2533	767	" " " Spring
907D	782	" " " " Screw
24324	—	" " Body
24998	—	" " " 24324 with 24009 and two 1053D
24009	2006	Shuttle Race Cap
1053D	2006	" " " Screw
24325	2046	Shuttle Race complete, Nos. 907D, 2419, 2533, 24323, 24998 and two each 391D and 2532
145D	782	Shuttle Race Screw
12431	—	" " Slide
12432	2004	Shuttle Race Slide complete, Nos. 4307, 12431 and two 725E
4307	772	Shuttle Race Slide Spring
725E	1387	" " " " Screw
44009	8315	Slack Thread Regulator
225F	1323	" " " Adjusting Screw
2102	5806	Tension Disc
1560C	783	" Regulating Thumb Nut
32572	5806	" Releasing Disc
43944	5806	" " Lever
12398	773	" " " Hinge Pin
12329	772	" " " Spring
32574	5806	" " Pin
50327C	5806	" Screw Stud
44141	—	" " " 50327C with 1560C
43945	5806	" Spring

NO.	PLATE	NAME
44118	—	Tension complete, Nos. 7336, 32572, 32574, 43945, 43946, 44141 and two 2102
52454	5842	Thread Retainer
50429c	—	" " Set Screw
12404	770	" Take-up Crank
3094	773	" " " Wedge
690E	782	" " " " Screw
12408	770	" " " Lever
775E	782	" " " Cap Screw
12166	773	" " " Hinge Pin
12409	770	" " " Link
11204	770	" " " " Hinge Pin
435c	5806	" " " " " " " Set Screw
12410	—	Thread Take-up Lever complete, Nos. 12166, 12408 and 12409
43946	5806	Thread Take-up Spring
7336	772	" " " Regulator
448c	783	" " " " Set Screw
24306	1344	Throat Plate for 24303
691F	782	" " Screw
24079	2644	Drip Pan with four 1 in. wire nails

LIST OF PARTS COMPLETE FOR MACHINE No. 44-23

UPPER AND LOWER POSITIVE FEEDING MECHANISM, ALTER- NATING PRESSERS. FOR GENERAL WORK.

NO.	PLATE	NAME
*24340	—	Arm with 11104
8582	773	" Dowel Pin
12453	773	" Oil Tube for intermediate bearing
11119	773	" " " with 29599, for oiling 12408 and 19365
12454	773	Arm Oil Tube with 29599, for oiling 12409
24131	2014	" " " " " " " 20283
29599	2014	" " " Packing (felt)
748E	782	" Screw (back)
868E	1366	" " (front)
16511	1349	" Shaft
*11104	—	" " Bushing (front)
12357	767	" " Flanged Bushing (back)
448c	783	" " " " " " " Set Screw
144D	782	Arm Shaft Screw
12193	2004	" Side Cover
286D	783	" " " Thumb Screw
12403	772	" Spool Pin and Thread Eyelet
11241	2003	" " " Washer (cloth)
24296	1348	Balance Wheel (power) light rim, 2 $\frac{3}{8}$ in. pulley, with two 448c
24297	1340	Balance Wheel Oil Cover
210D	1343	" " " " Screw
448c	783	" " " Set Screw
*24341	—	Bed
20197	1350	Crank Connecting Rod with 20198 and two 896E
*20198	—	Crank Connecting Rod Cap
896E	773	" " " " Screw
908C	773	" " " Hinge Screw
1619E	773	" " " " " Nut
19354	—	Face Plate
19355	1311	Face Plate complete, Nos. 2827, 12150 and 19354

NO.	PLATE	NAME
219D	774	Face Plate Screw.....
44181	—	“ “ Thread Guard (lower).....
12150	773	“ “ “ “ “ 44181 with 12152.....
12152	773	Face Plate Thread Guard (lower) Rivet... ..
2827	773	“ “ “ “ (upper) with 8505
8505	773	“ “ “ “ “ Rivet.....
24342	1311	Feed Bar (lower).....
4653	1354	“ “ “ Hinge Pin.....
1517E	1366	“ “ “ “ “ Nut.....
711c	1366	“ “ “ “ “ Screw Bear- ing.....
1517E	1366	Feed Bar (lower) Hinge Pin Screw Bear- ing Nut.....
24343	1354	Feed Bar (upper) with 620c.....
3033	770	“ Connecting Link.....
375c	782	“ “ “ Hinge Screw.....
1518E	783	“ “ “ “ “ Nut.....
24344	1267	Feed Dog (lower).....
208E	782	“ “ “ Screw.....
24345	1354	“ “ (upper).....
330D	1366	“ “ “ Screw.....
20283	1315	“ and Feed Lifting Eccentric with 446c
446c	783	“ “ “ “ “ Set Screw
24036	1340	“ “ “ “ “ Sleeve...
20284	1350	“ Forked Connection.....
375c	782	“ “ “ Hinge Screw....
1518E	783	“ “ “ “ “ Nut
24349	1354	“ (upper) Lifting Bar.....
24350	1354	“ “ “ “ “ Hinge Pin....
620c	782	“ “ “ “ “ “ Set Screw.....
24969	2551	Feed Lifting Rock Shaft.....
24970	—	Feed Lifting Rock Shaft complete, Nos. 12376 and 24969.....
12376	770	Feed Lifting Rock Shaft Crank with 157J and 1813.....
157J	782	Feed Lifting Rock Shaft Crank Clamping Screw.....
1813	783	Feed Lifting Rock Shaft Crank Roller and Stud.....
43976	2551	Feed Lifting Rock Shaft Crank Connect- ing Rod with 43977 and two 966E.....
*43977	—	Feed Lifting Rock Shaft Crank Connect- ing Rod Cap.....
966E	5806	Feed Lifting Rock Shaft Crank Connect- ing Rod Cap Screw.....

NO.	PLATE	NAME
375c	782	Feed Lifting Rock Shaft Crank Connect- Rod Hinge Screw.....
1518E	783	Feed Lifting Rock Shaft Crank Connect- ing Rod Hinge Screw Nut.....
307c	783	Feed Lifting Rock Shaft Screw Centre... ..
56814	—	“ “ “ “ “ “ 307c with 1513J.....
1513J	783	Feed Lifting Rock Shaft Screw Centre Nut.....
24348	1354	“ Pressure Spring.....
207F	1341	“ “ “ Screw.....
3039	768	“ Regulator.....
1128E	2009	“ “ Hinge Screw.....
818D	783	“ “ Thumb Screw.....
24346	1349	“ Rock Shaft.....
24377	—	Feed Rock Shaft complete, Nos. 24346 and 29633.....
29633	1354	Feed Rock Shaft Crank with 157J.....
157J	782	“ “ “ “ Clamping Screw
307c	783	“ “ “ “ Screw Centre.....
56814	—	“ “ “ “ “ “ 307c with 1513J.....
1513J	783	Feed Rock Shaft Screw Centre Nut.....
12391	767	Lifting Presser Bar (hollow).....
19356	1312	“ “ “ “ Bell Crank.....
199D	1312	“ “ “ “ “ Cap Screw
19357	1312	“ “ “ “ “ Connecting Link.....
199D	1312	Lifting Presser Bar Bell Crank Connecting Link Cap Screw.....
24351	1354	Lifting Presser Bar Bell Crank Driving Arm.....
2049	773	Lifting Presser Bar Bell Crank Driving Arm Pin.....
19359	1312	Lifting Presser Bar Bell Crank Driving Arm Shaft.....
19360	1311	Lifting Presser Bar Bell Crank Driving Arm Shaft Bracket.....
24352	—	Lifting Presser Bar Bell Crank Driving Arm Shaft Bracket complete, Nos. 2049, 19359, 19360 and 24351.....
965D	1312	Lifting Presser Bar Bell Crank Driving Arm Shaft Bracket Screw.....
19362	1313	Lifting Presser Bar Bell Crank Driving Arm Eccentric Connection.....
375c	782	Lifting Presser Bar Bell Crank Driving Arm Eccentric Connection Hinge Screw

NO.	PLATE	NAME
1518E	783	Lifting Presser Bar Bell Crank Driving Arm Eccentric Connection Hinge Screw Nut.....
19363	1312	Lifting Presser Bar Guide Bracket with 453c.....
453c	783	Lifting Presser Bar Guide Bracket Set Screw.....
4855	1312	Lifting Presser Bar Lifter.....
689c	782	" " " " Screw.....
1520E	783	" " " " " Nut.....
12327	770	" " " Lifting and Releasing Lever Bracket.....
11167	767	Lifting Presser Bar Spring (light) .051 wire
NOTE: No. 11167 is sent with this Machine unless another Spring is specified on order.		
12139	2004	Lifting Presser Bar Spring (medium) .055 wire.....
20023	2004	Lifting Presser Bar Spring (heavy) .063 wire.....
11170	771	Lifting Presser Bar Spring Washer.....
19364	1312	" " Foot.....
193D	1312	" " " Screw.....
19229	2004	Needle Bar (hollow) for high lift.....
12382	770	" " Connecting Link with 794E.....
794E	782	" " " " Adjusting Screw.....
12383	—	Needle Bar Connecting Stud.....
1904	770	" " " " Roller (roller only).....
453c	783	Needle Bar Connecting Stud Set Screw.....
12384	770	Needle Bar Connecting Stud complete, Nos. 453c, 1904 and 12383.....
19365	1311	Needle Bar Crank and Lifting Eccentric with 448c and 743c.....
448c	783	Needle Bar Crank and Lifting Eccentric Set Screw.....
743c	1313	Needle Bar Crank and Lifting Eccentric Position Screw.....
936E	773	Needle Bar Screw Bushing.....
24101	—	" Clamp Body.....
808F	782	" " Screw.....
24102	1353	" " Thread Guide.....
651D	1353	" " " " Screw.....
24103	1353	Needle Clamp (high lift) complete, Nos. 651D, 808F, 24101 and 24102.....
24104	1350	Oscillating Rock Shaft.....

NO.	PLATE	NAME
24105	—	Oscillating Rock Shaft complete, Nos. 4784, 12388 and 24104.....
12388	767	Oscillating Rock Shaft Hinge Pin.....
878J	783	" " " " " Oil Hole Stop Screw.....
12459	773	Oscillating Rock Shaft Hinge Pin Oil Hole Stop Screw Washer (leather).....
448c	783	Oscillating Rock Shaft Hinge Pin Set Screw.....
4784	1353	Oscillating Rock Shaft Oil Pad.....
16509	766	" Shaft.....
19496	—	" " Crank for 19447.....
44134	—	" " " " 44135.....
19447	1353	Oscillating Shaft Crank complete, Nos. 457c, 1518E, 19449 and 19496.....
44135	5806	Oscillating Shaft Crank complete, Nos. 1518E, 19449, 44134 and two 453c.....
2049	773	Oscillating Shaft Crank Pin.....
457c	783	" " " " Set Screw for 19447.....
453c	783	" " " " " 44135.....
19448	1353	" " " Slide Block.....
229D	782	" " " " " Cap Screw.....
12424	773	Oscillating Shaft Crank Slide Block Cap Screw Washer.....
988c	1353	Oscillating Shaft Crank Slide Block Screw Stud.....
1518E	783	Oscillating Shaft Crank Slide Block Screw Stud Nut.....
19449	1353	Oscillating Shaft Crank Slide Block complete, Nos. 229D, 988c, 12424 and 19448.....
688J	783	Pressure Regulating Thumb Screw.....
2996	771	Shuttle Bobbin.....
15140	1353	" " Case Latch.....
2973	771	" " " " Lever.....
2974	771	" " " " " Fulcrum Pin.....
2975	771	Shuttle Bobbin Case Latch Spring.....
592E	782	" " " " Stop Screw.....
15141	—	Shuttle Bobbin Case Hinge, Nos. 2973, 2974 and 15140.....
7553	771	Shuttle Bobbin Case Position Finger.....
2523	771	" " " " " Rivet.....
24412	1361	" " " " " Plate.....
391D	1366	" " " " " Screw.....
24074	771	Shuttle Bobbin Case complete, Nos. 591E, 592E, 2523, 2975, 7553, 15098 and 15141.....

NO.	PLATE	NAME
12393	771	Shuttle Body
591F	782	" Tension Regulating Screw
15098	771	" " Spring
19292	771	Shuttle, 1 $\frac{1}{4}$ in. diam., Nos. 2996, 12393 and 24074
*12394	—	Shuttle Driver
12444	771	" " 12394 with two 1266c
2049	773	" " Pin
1266c	5806	" " Set Screw
2531	767	" Race Back
2532	772	" " " Position Pin
2533	767	" " " Spring
907D	782	" " " " Screw
24413	—	" " Body
25000	—	" " " 24413 with 24414 and two 1053D
24414	1362	Shuttle Race Cap
1053D	2006	" " " Screw
24415	1361	Shuttle Race complete, Nos. 907D, 2531, 2533, 24412, 25000 and two each 391D and 2532
145D	782	Shuttle Race Screw
12431	—	" " Slide
12432	2004	Shuttle Race Slide complete, Nos. 4307, 12431 and two 725E
4307	772	Shuttle Race Slide Spring
725E	1387	" " " " Screw
2921	771	Tension Disc
1560c	783	" Regulating Thumb Nut
20037	2009	" Releaser
12397	772	" Releasing Lever
12398	773	" " " Hinge Pin
12329	772	" " " Spring
413c	783	" Screw Stud
33892	—	" " " 413c with 1560c
2923	771	" Spring
12149	2014	" Thread Guard
44147	—	Tension complete, Nos. 2923, 7336, 8511, 20037, 33892 and two 2921
52454	5842	Thread Retainer
50429c	—	" " Set Screw
12404	770	" Take-up Crank
3094	773	" " " Wedge
690E	782	" " " " Screw
12408	770	" " Lever
775E	782	" " Cap Screw
12166	773	" " " Hinge Pin

NO.	PLATE	NAME
12409	770	Thread Take-up Lever Link
11204	770	" " " " Hinge Pin
435c	5806	" " " " " " Set Screw
12410	—	Thread Take-up Lever complete, Nos. 12166, 12408 and 12409
8511	773	Thread Take-up Spring
7336	772	" " " Regulator
448c	783	" " " " Set Screw
24353	1267	Throat Plate, large needle hole, for 24344
NOTE: No. 24353 is sent with this Machine unless another Throat Plate is specified on order.		
24354	—	Throat Plate, small needle hole, for 24344
691F	782	" " Screw
24079	2644	Drip Pan with four 1 in. wire nails

**LIST OF PARTS COMPLETE
FOR
MACHINE No. 44-24**

**DROP FEED, FOR TUCKING, WITH TUCK FOLDING ATTACHMENT,
WHICH CAN BE READILY ADJUSTED TO MAKE TUCKS OF
ANY WIDTH FROM 1/4 INCH TO 1 1/4 INCHES FROM THE
RIGHT OR LEFT HAND SIDE OF THE GOODS.**

NO.	PLATE	NAME
*24335	—	Arm with 11104.....
8582	773	" Dowel Pin.....
12453	773	" Oil Tube for intermediate bearing... ..
12454	773	" " " with 29599, for oiling 12409.....
11119	773	" " " " " " " 12408.....
24131	2014	" " " " " " " 20283.....
29599	2014	" " " Packing (felt).....
748E	782	" Screw (back).....
868E	1366	" " (front).....
16511	1349	" Shaft.....
*11104	—	" " Bushing (front).....
12357	767	" " Flanged Bushing (back).....
448C	783	" " " " " Set Screw.....
144D	782	Arm Shaft Screw.....
12480	767	" Side Cap.....
219D	774	" " " Screw.....
12193	2004	" " Cover.....
286D	783	" " " Thumb Screw.....
12403	772	" Spool Pin and Thread Eyelet.....
11241	2003	" " " Washer (cloth).....
24296	1348	Balance Wheel (power) light rim, 2 1/8 in. pulley, with two 448C.....
24297	1340	Balance Wheel Oil Cover.....
210D	1343	" " " " Screw.....
448C	783	" " Set Screw.....
*16503	—	Bed.....
20197	1350	Crank Connecting Rod with 20198 and two 896E.....
*20198	—	Crank Connecting Rod Cap.....
896E	773	" " " " Screw.....
908C	773	" " " Hinge Screw.....
1619E	773	" " " " " Nut

NO.	PLATE	NAME
20057	—	Face Plate.....
20058	1340	Face Plate complete, Nos. 2827, 12150 and 20057.....
190D	782	Face Plate Screw.....
44181	—	" " Thread Guard (lower).....
12150	773	" " " " " 44181 with 12152.....
12152	773	Face Plate Thread Guard (lower) Rivet... ..
2827	773	" " " " (upper) with 8505.....
8505	773	" " " " " Rivet... ..
286D	783	" " Thumb Screw.....
12368	767	Feed Bar.....
313C	783	" " Screw Centre.....
56813	—	" " " " 313c with 1519J... ..
1519J	783	" " " " Nut.....
3033	770	" Connecting Link.....
375C	782	" " " " Hinge Screw.....
1518E	783	" " " " " Nut.....
20138	1263	" Dog, 13 teeth (12 teeth to the inch) for shirt work, beveled for hemmer... ..
208E	782	Feed Dog Screw.....
20283	1315	" and Feed Lifting Eccentric with 446C.....
446C	783	" " " " " Set Screw.....
24036	1340	" " " " " Sleeve.....
20284	1350	" Forked Connection.....
375C	782	" " " Hinge Screw.....
1518E	783	" " " " " Nut.....
24969	2551	" Lifting Rock Shaft.....
24970	—	Feed Lifting Rock Shaft complete, Nos. 12376 and 24969.....
12376	770	Feed Lifting Rock Shaft Crank with 157J and 1813.....
157J	782	Feed Lifting Rock Shaft Crank Clamping Screw.....
1813	783	Feed Lifting Rock Shaft Crank Roller and Stud.....
43976	2551	Feed Lifting Rock Shaft Crank Connect- ing Rod with 43977 and two 966E.....
*43977	—	Feed Lifting Rock Shaft Crank Connect- ing Rod Cap.....
966E	5806	Feed Lifting Rock Shaft Crank Connect- ing Rod Cap Screw.....
375C	782	Feed Lifting Rock Shaft Crank Connect- ing Rod Hinge Screw.....
1518E	783	Feed Lifting Rock Shaft Crank Connect- ing Rod Hinge Screw Nut.....

NO.	PLATE	NAME
307c	783	Feed Lifting Rock Shaft Screw Centre...
56814	—	“ “ “ “ “ “ 307c with 1513J.....
1513J	783	Feed Lifting Rock Shaft Screw Centre Nut
3039	768	“ Regulator.....
1128E	2009	“ “ Hinge Screw.....
818D	783	“ “ Thumb Screw.....
16506	766	“ Rock Shaft.....
24376	—	Feed Rock Shaft complete, Nos. 16506 and 29633.....
29633	1354	Feed Rock Shaft Crank with 157J.....
157J	782	“ “ “ “ Clamping Screw.
307c	783	“ “ “ Screw Centre.....
56814	—	“ “ “ “ “ 307c with 1513J.....
1513J	783	Feed Rock Shaft Screw Centre Nut.....
12381	767	Needle Bar (hollow).....
12382	770	“ “ Connecting Link with 794E..
794E	782	“ “ “ “ Adjusting Screw.....
*12383	—	Needle Bar Connecting Stud.....
1904	770	“ “ “ “ Roller (roller only).....
453c	783	Needle Bar Connecting Stud Set Screw.
12384	770	Needle Bar Connecting Stud complete, Nos. 453c, 1904 and 12383.....
20188	767	Needle Bar Crank with 858c and 1065c..
1065c	1366	“ “ “ Position Screw.....
858c	783	“ “ “ Set Screw.....
936E	773	“ “ Screw Bushing.....
4302	773	“ “ Thread Guard.....
233D	782	“ “ “ “ Screw.....
4303	773	“ Clamp with 808F.....
808F	782	“ “ Screw.....
24104	1350	Oscillating Rock Shaft.....
24105	—	Oscillating Rock Shaft complete, Nos. 4784, 12388 and 24104.....
12388	767	Oscillating Rock Shaft Hinge Pin.....
878J	783	“ “ “ “ Oil Hole Stop Screw.....
12459	773	Oscillating Rock Shaft Hinge Pin Oil Hole Stop Screw Washer (leather).....
448c	783	Oscillating Rock Shaft Hinge Pin Set Screw.....

NO.	PLATE	NAME
4784	1353	Oscillating Rock Shaft Oil Pad.....
16509	766	“ Shaft.....
19496	—	“ “ Crank for 19447.....
44134	—	“ “ “ “ 44135.....
19447	1353	Oscillating Shaft Crank complete, Nos. 457c, 1518E, 19449 and 19496.....
44135	5806	Oscillating Shaft Crank complete, Nos. 1518E, 19449, 44134 and two 453c.....
2049	773	Oscillating Shaft Crank Pin.....
457c	783	“ “ “ Set Screw for 19447
453c	783	“ “ “ “ “ 44135
19448	1353	“ “ “ Slide Block.....
229D	782	“ “ “ “ “ Cap Screw.....
12424	773	Oscillating Shaft Crank Slide Block Cap Screw Washer.....
988c	1353	Oscillating Shaft Crank Slide Block Screw Stud.....
1518E	783	Oscillating Shaft Crank Slide Block Screw Stud Nut.....
19449	1353	Oscillating Shaft Crank Slide Block com- plete, Nos. 229D, 988c, 12424 and 19448
12391	767	Presser Bar (hollow).....
20059	1341	“ “ Guide Bracket with 453c....
453c	783	“ “ “ Set Screw....
2062	771	“ “ Lifter.....
689c	782	“ “ “ Screw.....
1520E	783	“ “ “ “ Nut.....
12327	770	“ “ Lifting and Releasing Lever Bracket.....
11167	767	Presser Bar Spring (light) .051 wire.....
NOTE: No. 11167 is sent with this Machine unless another Spring is specified on order.		
12139	2004	Presser Bar Spring (medium) .055 wire....
20023	2004	“ “ “ (heavy) .063 wire.....
11170	771	“ “ “ Washer.....
12144	780	“ Foot for 20138.....
190D	782	“ “ Screw.....
688J	783	Pressure Regulating Thumb Screw.....
19131	5737	Shuttle Bobbin.....
20649	5737	“ “ Case Latch.....
2973	5737	“ “ “ “ Lever.....
2974	5737	“ “ “ “ Fulcrum Pin.....
2975	5737	Shuttle Bobbin Case Latch Spring.....
592E	5737	“ “ “ “ Stop Screw...

NO.	PLATE	NAME
20650	—	Shuttle Bobbin Case Hinge, Nos. 2973, 2974 and 20649.....
20755	5737	Shuttle Bobbin Case Position Finger.....
2523	5737	" " " " " Rivet.....
24323	2046	" " " " " Plate.....
391D	1366	" " " " " Screw.....
20756	5737	Shuttle Bobbin Case complete, Nos. 591E, 592E, 2523, 2975, 20650, 20654 and 20755.....
20757	5737	Shuttle Body.....
591F	5737	" " Tension Regulating Screw.....
20654	5737	" " Spring.....
20758	5737	Shuttle, 1 1/4 in. diam., Nos. 19131, 20756 and 20757.....
19406	2012	Shuttle Driver with two 1266c.....
2049	773	" " Pin.....
1266c	5806	" " Set Screw.....
2419	2006	" Race Back.....
2532	772	" " " Position Pin.....
2533	767	" " " Spring.....
907D	782	" " " Screw.....
24324	—	" " Body.....
24998	—	" " " 24324 with 24009 and two 1053D.....
24009	2006	Shuttle Race Cap.....
1053D	2006	" " " Screw.....
24325	2046	Shuttle Race complete, Nos. 907D, 2419, 2533, 24323, 24998 and two each 391D and 2532.....
145D	782	Shuttle Race Screw.....
12431	—	" " Slide.....
12432	2004	Shuttle Race Slide complete, Nos. 4307, 12431 and two 725E.....
4307	772	Shuttle Race Slide Spring.....
725E	1387	" " " " Screw.....
20060	1311	Slack Thread Regulator.....
225F	1323	" " " Adjusting Screw..
2102	5806	Tension Disc.....
1560c	783	" Regulating Thumb Nut.....
32572	5806	" Releasing Disc.....
43944	5806	" " Lever.....
12398	773	" " " Hinge Pin.....
12329	772	" " " Spring.....
32574	5806	" " Pin.....
50327c	5806	" Screw Stud.....
44141	—	" " " 50327c with 1560c...
43945	5806	" Spring.....

NO.	PLATE	NAME
44118	—	Tension complete, Nos. 7336, 32572, 32574, 43945, 43946, 44141 and two 2102
52454	5842	Thread Retainer.....
50429c	—	" " Set Screw.....
12404	770	" Take-up Crank.....
3094	773	" " " Wedge.....
690E	782	" " " " Screw.....
12408	770	" " Lever.....
775E	782	" " " Cap Screw.....
12166	773	" " " Hinge Pin.....
12409	770	" " " Link.....
11204	770	" " " " Hinge Pin...
435c	5806	" " " " " Set Screw.....
12410	—	Thread Take-up Lever complete, Nos. 12166, 12408 and 12409.....
43946	5806	Thread Take-up Spring.....
7336	772	" " " Regulator.....
448c	783	" " " " Set Screw.....
26891	2631	Throat Plate, small needle hole, for 20138
691F	782	" " Screw.....
26892	2629	Tuck Folder (under, right) for 26895.....
26896	2630	" " " " " 26899.....
401E	2442	" " " " Screw for 26895
756E	2442	" " " " " " 26899
26502	2629	" " (upper, left) for 26895.....
26897	2630	" " " " " 26899.....
4621	2442	" " " " Guide Pin.....
337D	2442	" " " " Screw.....
26893	2629	" " Arm with 2301.....
691F	2442	" " " Screw.....
26894	2629	" " Guide (under, left) with 4621, for 26895.....
26898	2630	Tuck Folder Guide (under, left) with 4621, for 26899.....
4621	2442	Tuck Folder Guide (under, left) Rivet...
401E	2442	" " " " " Screw...
26437	2629	" " Sliding Bracket with 2301, for 26895.....
26449	2630	Tuck Folder Sliding Bracket with 2301, for 26899.....
26438	2629	Tuck Folder Sliding Bracket Cap.....
233D	2442	" " " " " Screw..
514c	2442	" " " " " Locking Pin
26439	2442	" " " " " Bushing with 468c.....

NO.	PLATE	NAME
1564D	2442	Tuck Folder Sliding Bracket Locking Pin Head
2297	2442	Tuck Folder Sliding Bracket Locking Pin Spring
2296	2442	Tuck Folder Sliding Bracket Locking Pin Spring Bushing
468c	2442	Tuck Folder Sliding Bracket Locking Pin Spring Bushing Set Screw
2301	2442	Tuck Folder Sliding Bracket Stop Pin
233D	2442	" " " " Screw
26592	2629	" Guide
2301	2442	" " Guide Pin
26450	2630	" " (under)
26451	2630	" " (upper)
26636	2630	" " Division Block
7476	2442	" " Rivet
26637	—	Tuck Guide complete, Nos. 26450, 26451, 26636 and three 7476
658D	2442	Tuck Guide Thumb Screw
26895	—	Tuck Folding Attachment complete, for folding the tuck to the right, beginning at the left hand side of the goods, Nos. 514c, 1564D, 2296, 2297, 4621, 26437 to 26439, 26502, 26 92, 26891 to 26894, two each 337D, 658D, three 233D and four 401E
26899	—	Tuck Folding Attachment complete, for folding the tuck to the right, beginning at the right hand side of the goods, Nos. 514c, 1564D, 2296, 2297, 4621, 26438, 26439, 26449, 26637, 26891, 26893, 26896 to 26898, two each 337D, 401E, 658D, 756E and three 233D
24079	2641	Drip Pan with four 1 in. wire nails

LIST OF PARTS COMPLETE

FOR

MACHINE No. 44-28

DROP FEED, SINGLE NEEDLE, POSITIVE ADJUSTABLE RUFFLING MECHANISM, WITH TRIMMING ATTACHMENT. FOR CLOTH.

NO.	PLATE	NAME
*24407	—	Arm with 11104
8582	773	" Dowel Pin
12453	773	" Oil Tube, for intermediate bearing ..
12454	773	" " " with 29599, for oiling 12409
11119	773	" " " " " " 12408, 16569 and 24207
24131	2014	Arm Oil Tube with 29599, for oiling 20283
29599	2014	" " " Packing (felt)
748E	782	" Screw (back)
868E	1366	" " (front)
24195	1349	" Shaft
*11104	—	" " Bushing (front)
12357	767	" " Flanged Bushing (back)
448c	783	" " " " " Set Screw
144D	782	Arm Shaft Screw
12193	2004	" Side Cover
286D	783	" " " Thumb Screw
12403	772	" Spool Pin and Thread Eyelet
11241	2003	" " " Washer (cloth)
24296	1348	Balance Wheel (power) light rim, 2 $\frac{3}{8}$ in. pulley, with two 448c
24297	1340	Balance Wheel Oil Cover
210D	1343	" " " " Screw
448c	783	" " Set Screw
*16596	—	Bed
20197	1350	Crank Connecting Rod with 20198 and two 896E
*20198	—	Crank Connecting Rod Cap
896E	773	" " " " Screw
908c	773	" " " " Hinge Screw
1619E	773	" " " " " Nut
16558	—	Face Plate

NO.	PLATE	NAME
16559	1351	Face Plate complete, Nos. 2827, 12150 and 16558.....
217D	1312	Face Plate Screw.....
44181	—	“ “ Thread Guard (lower).....
12150	773	“ “ “ “ “ 44181 with 12152.....
12152	773	Face Plate Thread Guard (lower) Rivet. . .
2827	773	“ “ “ “ (upper) with 8505
8505	773	“ “ “ “ “ Rivet.
12368	767	Feed Bar.....
313C	783	“ “ Screw Centre.....
56813	—	“ “ “ “ 313c with 1519J..
1519J	783	“ “ “ “ Nut.....
3033	770	“ Connecting Link.....
375C	782	“ “ “ Hinge Screw.....
1518E	783	“ “ “ “ “ Nut.
24408	1271	“ Dog.....
208E	782	“ “ Screw.....
20283	1315	“ and Feed Lifting Eccentric with 446C
446C	783	“ “ “ “ “ Set Screw
24036	1340	“ “ “ “ “ Sleeve. . .
20284	1350	“ Forked Connection.....
375C	782	“ “ “ Hinge Screw. . .
1518E	783	“ “ “ “ “ Nut
24969	2551	“ Lifting Rock Shaft.....
24970	—	Feed Lifting Rock Shaft complete, Nos. 12376 and 24969.....
12376	770	Feed Lifting Rock Shaft Crank with 157J and 1813.....
157J	782	Feed Lifting Rock Shaft Crank Clamping Screw.....
1813	783	Feed Lifting Rock Shaft Crank Roller and Stud.....
43976	2551	Feed Lifting Rock Shaft Crank Connecting Rod with 43977 and two 966E. . . .
*43977	—	Feed Lifting Rock Shaft Crank Connecting Rod Cap.....
966E	5806	Feed Lifting Rock Shaft Crank Connecting Rod Cap Screw.....
375C	782	Feed Lifting Rock Shaft Crank Connecting Rod Hinge Screw.....
1518E	783	Feed Lifting Rock Shaft Crank Connecting Rod Hinge Screw Nut.....
307C	783	Feed Lifting Rock Shaft Screw Centre. . .
56814	—	“ “ “ “ “ “ 307c with 1513J.....

NO.	PLATE	NAME
1513J	783	Feed Lifting Rock Shaft Screw Centre Nut
3039	768	“ Regulator.....
1128E	2009	“ “ Hinge Screw.....
818D	783	“ “ Thumb Screw.....
16506	766	“ Rock Shaft.....
24376	—	Feed Rock Shaft complete, Nos. 16506 and 29633.....
29633	1354	Feed Rock Shaft Crank with 157J.....
157J	782	“ “ “ “ Clamping Screw.
307C	783	“ “ “ Screw Centre.....
56814	—	“ “ “ “ “ 307c with 1513J.....
1513J	783	Feed Rock Shaft Screw Centre Nut.....
5726	1271	Knife.....
NOTE: Two No. 5726 are sent with this Machine		
620F	782	Knife Adjusting Screw.....
19297	1315	“ Bar with 2301.....
24431	1352	“ “ Crank with 191c.....
1162C	1366	“ “ “ Coupling Pin.....
1564D	2442	“ “ “ “ “ Head. . .
2297	2442	“ “ “ “ “ Spring. . .
2022	773	“ “ “ Pin.....
191C	1366	“ “ “ Set Screw.....
24432	—	Knife Bar Crank complete, Nos. 1162c, 1564D, 2297 and 24431.....
16563	1315	Knife Bar Driving Crank (forked).....
16564	1315	“ “ “ “ Bracket.....
24433	—	Knife Bar Driving Crank Bracket complete, Nos. 2022, 16563, 16564 and 24432
647C	774	Knife Bar Driving Crank Bracket Screw.
24122	1317	“ “ Lifting Spring.....
24123	1317	“ “ “ “ Case.....
24124	1317	“ “ “ “ Guide.....
*24906	—	“ “ “ “ “ 24124 with 2523 and 24125.....
24125	1317	Knife Bar Lifting Spring Guide Bracket. . .
621D	1317	“ “ “ “ “ “ Screw
2523	1317	“ “ “ “ “ Pin.....
2301	1317	“ “ Stop Pin.....
24128	—	Knife Bar complete, Nos. 621D, 19297, 19391, 24109, 24906 and three 335H. . . .
19391	8376	Knife Holder with 620F, 2291 and two 223F
24109	8376	“ “ Handle.....
335H	1317	“ “ “ Screw.....
335H	1317	“ “ Screw.....
223F	1317	“ Screw.....

NO.	PLATE	NAME
2291	1317	Knife Screw Washer.....
16568	1352	Needle Bar with 620F, 1072F and 24391...
12382	770	" " Connecting Link with 794E...
794E	782	" " " " Adjusting Screw.....
*12383	—	Needle Bar Connecting Stud.....
1904	770	" " " " Roller (roller only).....
453c	783	Needle Bar Connecting Stud Set Screw...
12384	770	Needle Bar Connecting Stud complete, Nos. 453c, 1904 and 12383.....
16569	1315	Needle Bar Crank (eccentric) with 448c and 743c.....
743c	1317	Needle Bar Crank Position Screw.....
448c	783	" " " Set Screw.....
24391	8376	" " Thread Guard.....
620F	782	" " " " Set Screw.....
1072F	1317	" Set Screw.....
24104	1350	Oscillating Rock Shaft.....
24105	—	Oscillating Rock Shaft complete, Nos. 4784, 12388 and 24104.....
12388	767	Oscillating Rock Shaft Hinge Pin.....
878J	783	" " " " " Oil Hole Stop Screw.....
12459	773	Oscillating Rock Shaft Hinge Pin Oil Hole Stop Screw Washer (leather).....
448c	783	Oscillating Rock Shaft Hinge Pin Set Screw.....
4784	1353	Oscillating Rock Shaft Oil Pad.....
16509	766	" Shaft.....
19496	—	" " Crank for 19447.....
44134	—	" " " " 44135.....
19447	1353	Oscillating Shaft Crank complete, Nos. 457c, 1518E, 19449 and 19496.....
44135	5806	Oscillating Shaft Crank complete, Nos. 1518E, 19449, 44134 and two 453c.....
2049	773	Oscillating Shaft Crank Pin.....
457c	783	" " " Set Screw for 19447
453c	783	" " " " " 44135
19448	1353	" " " Slide Block.....
229D	782	" " " " " Cap Screw.....
12424	773	Oscillating Shaft Crank Slide Block Cap Screw Washer.....
988c	1353	Oscillating Shaft Crank Slide Block Screw Stud.....

NO.	PLATE	NAME
1518E	783	Oscillating Shaft Crank Slide Block Screw Stud Nut.....
19449	1353	Oscillating Shaft Crank Slide Block com- plete, Nos. 229D, 988c, 12424 and 19448
12391	767	Presser Bar (hollow).....
12326	770	" " Guide Bracket with 453c....
453c	783	" " " " Set Screw....
2062	771	" " Lifter.....
689c	782	" " " Screw.....
1520E	783	" " " Nut.....
12327	770	" " Lifting and Releasing Lever Bracket.....
11167	767	Presser Bar Spring (light) .051 wire.....
NOTE: No. 11167 is sent with this Machine unless another Spring is specified on order.		
12139	2004	Presser Bar Spring (medium) .055 wire...
20023	2004	" " " (heavy) .063 wire....
11170	771	" " " Washer.....
24411	1344	" Foot for 24408.....
NOTE: When ordering No. 24411 state required distance of trimmed edge from seam.		
NOTE: No. 24411, $\frac{3}{8}$ in gauge, is sent with this Ma- chine unless otherwise specified on order.		
190D	782	Presser Foot Screw.....
688J	783	Pressure Regulating Thumb Screw.....
26888	1344	Ruffling Arm (lower).....
26889	1344	" " (upper) with 190D and 219F
207F	1344	" " Adjusting Screw.....
2291	1344	" " " " Washer...
190D	782	" " Clamping Screw.....
26890	1344	Ruffling Arm (adjustable) Nos. 2291, 26888, 26889 and two 207F.....
28845	—	Ruffling Arm (adjustable) complete, Nos. 226D, 1550J, 24203 to 24206, 26890 and two 665D.....
24199	1323	Ruffling Arm Shaft.....
24200	1324	" " " Bracket (right).....
145D	1324	" " " " " Screw
24201	1324	" " " " (left).....
159D	1324	" " " " " Screw...
6533	1323	" " " Collar with 460c.....
460c	1323	" " " " Set Screw....
219F	774	" " Set Screw.....
24409	1344	" Blade.....
24203	1344	" " Holder.....

NO.	PLATE	NAME
226D	1344	Ruffling Blade Holder Cap Screw.....
24204	1344	" " " Spring.....
24205	1344	" " " " Stop.....
24206	1344	" " " Stud.....
1550J	1344	" " " Nut.....
665D	1344	" " Screw.....
24207	1323	" Eccentric with two 453c.....
24208	1323	" " Collar with 453c.....
453c	1323	" " " Set Screw.....
24219	1323	" " Connection with 24220 and two 742E.....
*24220	—	Ruffling Eccentric Connection Cap.....
742E	1323	" " " " Screw
24210	1324	" " " Washer ..
453c	1323	" " Set Screw.....
24211	1323	" Regulator with 225F.....
225F	1323	" " Set Screw.....
181D	1323	" " Stop Screw.....
1641E	1323	" " " " Nut.....
1108F	1323	" " Thumb Screw.....
1641E	1323	" " " " Nut...
24718	1352	" Separating Blade.....
4604	1385	" " " Rivet.....
43919	1352	" " " Shank.....
24410	1352	Ruffling Separating Blade on Shank com- plete, Nos. 24718, 43919 and two 4604
1423D	5742	Ruffling Separating Blade Screw.....
2996	771	Shuttle Bobbin.....
15140	1353	" " Case Latch.....
2973	771	" " " " Lever.....
2974	771	" " " " " Fulerum Pin.....
2975	771	Shuttle Bobbin Case Latch Spring.....
592E	782	" " " " Stop Screw...
15141	—	Shuttle Bobbin Case Hinge, Nos. 2973, 2974 and 15140.....
7553	771	Shuttle Bobbin Case Position Finger.....
2523	771	" " " " " Rivet
24412	1361	" " " " Plate.....
391D	1366	" " " " " Screw
24074	771	Shuttle Bobbin Case complete, Nos. 591F, 592E, 2523, 2975, 7553, 15098 and 15141
12393	771	Shuttle Body.....
591F	782	" Tension Regulating Screw.....
15098	771	" " Spring.....
19292	771	Shuttle, 1 1/8 in. diam., Nos. 2996, 12393 and 24074.....

NO.	PLATE	NAME
*12394	—	Shuttle Driver.....
12444	771	" " 12394 with two 1266c....
2049	773	" " Pin.....
1266c	5806	" " Set Screw.....
2531	767	" Race Back.....
2532	772	" " " Position Pin.....
2533	767	" " " Spring.....
907D	782	" " " " Screw.....
24413	—	" " Body.....
25000	—	" " " 24413 with 24414 and two 1053D.....
24414	1362	Shuttle Race Cap.....
1053D	2006	" " " Screw.....
24415	1361	Shuttle Race complete, Nos. 907D, 2531, 2533, 24412, 25000 and two each 391D and 2532.....
145D	782	Shuttle Race Serew.....
12431	—	" " Slide.....
12432	2004	Shuttle Race Slide complete, Nos. 4307, 12431 and two 725E.....
4307	772	Shuttle Race Slide Spring.....
725E	1387	" " " Screw.....
2921	771	Tension Disc.....
1560c	783	" Regulating Thumb Nut.....
20037	2009	" Releaser.....
12397	772	" Releasing Lever.....
12398	773	" " " Hinge Pin.....
12329	772	" " " Spring.....
413c	783	" Screw Stud.....
33892	—	" " " 413c with 1560c....
2923	771	" Spring.....
12149	2014	" Thread Guard.....
44147	—	Tension complete, Nos. 2923, 7336, 8511, 20037, 33892 and two 2921.....
52454	5842	Thread Retainer.....
50429c	—	" " Set Screw.....
12404	770	" Take-up Crank.....
3094	773	" " " Wedge.....
690E	782	" " " " Screw....
12408	770	" " Lever.....
775E	782	" " " Cap Screw.....
12166	773	" " " Hinge Pin.....
12409	770	" " " Link.....
11204	770	" " " " Hinge Pin...
435c	5806	" " " " " Set Screw.....

NO.	PLATE	NAME
12410	—	Thread Take-up Lever complete, Nos. 12166, 12408 and 12409.....
8511	773	Thread Take-up Spring.....
7336	772	" " " Regulator.....
448c	783	" " " " Set Screw.....
5730	1271	Throat Plate Cutting Bar.....

NOTE: When ordering No. 5730, state required distance of trimmed edge from seam.

NOTE: No. 5730, $\frac{1}{8}$ in. gauge, is sent with this Machine unless otherwise specified on order.

578D	8376	Throat Plate Cutting Bar Screw.....
5731	1271	" " Slide.....
236F	773	" " " Adjusting Screw.....
24429	1271	Throat Plate complete for 24408, Nos. 236F, 5730, 5731 and two 578D.....

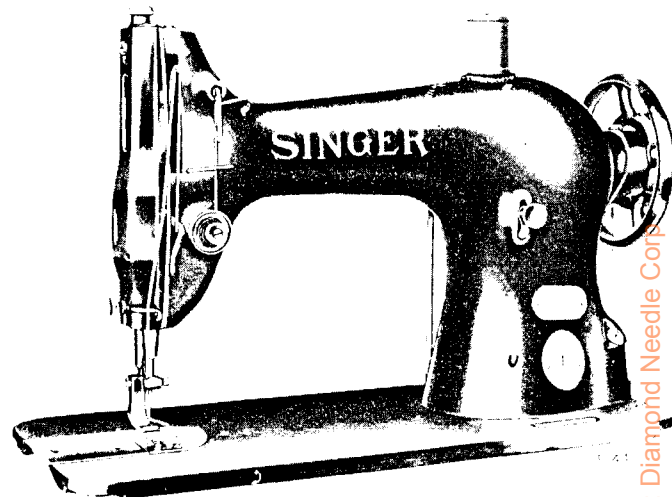
NOTE: When ordering No. 24429, state required distance of trimmed edge from seam.

NOTE: No. 24429, $\frac{1}{8}$ in. gauge, is sent with this Machine unless otherwise specified on order.

691F	782	Throat Plate Screw.....
24079	2644	Drip Pan with four 1 in. wire nails.....

LIST OF PARTS COMPLETE

FOR



MACHINE No. 44-29

FOR COLLARS AND CUFFS. DROP FEED.

NO.	PLATE	NAME
*24025	—	Arm with 11104.....
8582	773	" Dowel Pin.....
12453	773	" Oil Tube for intermediate bearing...
12454	773	" " " with 29599, for oiling 24099
11119	773	" " " " " " " 24068
24131	2014	" " " " " " " 24035
29599	2014	" " " Packing (felt).....
748E	782	" Screw (back).....
868E	1366	" " (front).....
24026	1339	" Shaft.....
*11104	—	" " Bushing (front).....
12357	767	" " Flanged Bushing (back).....
448c	783	" " " " " Set Screw.....

NO.	PLATE	NAME
144D	782	Arm Shaft Screw.....
12480	767	" Side Cap.....
219D	774	" " " Screw.....
12193	2004	" " Cover.....
286D	783	" " " Thumb Screw.....
12403	772	" Spool Pin and Thread Eyelet.....
11241	2003	" " " Washer (cloth).....
24328	1339	Balance Wheel, light rim, 2¼ in. pulley, with two 448c.....
24297	1340	Balance Wheel Oil Cover.....
210D	1343	" " " " Screw.....
448c	783	" " " Set Screw.....
*24027	—	Bed.....
24028	1339	Crank Connecting Rod with 24085 and two 896E.....
*24085	—	Crank Connecting Rod Cap.....
896E	773	" " " " Screw.....
908c	773	" " " " Hinge Screw.....
1619E	773	" " " " " Nut.....
20057	—	Face Plate.....
20C58	1340	Face Plate complete, Nos. 2827, 12150 and 20057.....
190D	782	Face Plate Screw.....
44181	—	" " Thread Guard (lower).....
12150	773	" " " " " 44181 with 12152.....
12152	773	Face Plate Thread Guard (lower) Rivet..
2827	773	" " " " (upper) with 8505
8505	773	" " " " " Rivet...
286D	783	" " Thumb Screw.....
24034	1340	Feed Bar.....
313c	783	" " Screw Centre.....
56813	—	" " " " 313c with 1519J.
1519J	783	" " " " Nut.....
3033	770	" Connecting Link.....
375c	782	" " " Hinge Screw.....
1518E	783	" " " " Nut.....
20115	1266	" Dog, 1/8 in. stitch (7 teeth front and 5 teeth back of needle).....
20163	1266	Feed Dog, 1/8 in. stitch, 1/4 in. higher (otherwise same as 20115).....
20116	1266	Feed Dog, 1/8 in. stitch, 16 teeth to the inch (6 teeth front and 5 teeth back of needle).....
20164	1266	Feed Dog, 1/8 in. stitch, 1/4 in. higher (otherwise same as 20116).....

NO.	PLATE	NAME
20137	1266	Feed Dog, 1/8 in. stitch, 22 teeth to the inch (8 teeth front and 5 teeth back of needle).....
NOTE: Nos. 20163 and 20164 are sent with this Ma- chine unless other Feed Dogs are specified on order.		
208E	782	Feed Dog Screw.....
24035	1340	" and Feed Lifting Eccentric with 448c
448c	783	" " " " " Set Screw
24036	1340	" " " " " Sleeve...
24037	1339	" Forked Connection.....
375c	782	" " " " Hinge Screw...
1518E	783	" " " " " Nut
16504	766	" Lifting Rock Shaft.....
16588	—	Feed Lifting Rock Shaft complete, Nos. 2049, 12376, 16504 and 16556.....
16556	2009	Feed Lifting Rock Shaft Crank (back) with 462c.....
2049	773	Feed Lifting Rock Shaft Crank (back) Pin.....
462c	773	Feed Lifting Rock Shaft Crank (back) Set Screw.....
12376	770	Feed Lifting Rock Shaft Crank (front) with 157J and 1813.....
157J	782	Feed Lifting Rock Shaft Crank (front) Clamping Screw.....
1813	783	Feed Lifting Rock Shaft Crank (front) Roller and Stud.....
12430	5764	Feed Lifting Rock Shaft Crank Connect- ing Rod with 12204 and two 966E.....
*12204	—	Feed Lifting Rock Shaft Crank Connect- ing Rod Cap.....
966E	5806	Feed Lifting Rock Shaft Crank Connect- ing Rod Cap Screw.....
375c	782	Feed Lifting Rock Shaft Crank Connect- ing Rod Hinge Screw.....
1518E	783	Feed Lifting Rock Shaft Crank Connect- ing Rod Hinge Screw Nut.....
307c	783	Feed Lifting Rock Shaft Screw Centre...
56814	—	" " " " " 307c with 1513J.....
1513J	783	Feed Lifting Rock Shaft Screw Centre Nut
3039	768	" Regulator.....
1128E	2009	" " Hinge Screw.....
818D	783	" " Thumb Screw.....
24585	8375	" " " " Stop.....
16506	766	" Rock Shaft.....

NO.	PLATE	NAME
24376	—	Feed Rock Shaft complete, Nos. 16506 and 29633.....
29633	1354	Feed Rock Shaft Crank with 157J.....
	157J 782	“ “ “ “ Clamping Screw
	307c 783	“ “ “ “ Screw Centre.....
56814	—	“ “ “ “ “ 307c with 1513J.....
	1513J 783	Feed Rock Shaft Screw Centre Nut.....
24451	2647	Needle Bar.....
24442	2647	“ “ Bushing with 29532.....
	1133E 8376	“ “ “ “ Set Screw.....
24040	1341	“ “ Connecting Link with 794E..
	794E 782	“ “ “ “ Adjusting Screw.....
	775E 782	Needle Bar Connecting Link Cap Screw..
24041	1341	“ “ “ “ Stud with 207E..
	207E 1341	“ “ “ “ Clamping Screw.....
24052	1340	Needle Bar Crank with 858c, 1036c, 1037c and 1065c.....
	1065c 1366	Needle Bar Crank Position Screw.....
	858c 783	“ “ “ “ Set Screw.....
	862D 1341	“ “ “ “ Hole Plug Screw.....
29532	1341	“ “ “ “ Oil Cup.....
24452	2647	“ “ “ “ Gib.....
24453	2647	“ “ Clamp with 196F and 24452.....
	196F 772	“ “ “ “ Screw.....
24043	1340	Oscillating Rock Shaft.....
24044	—	Oscillating Rock Shaft complete, Nos. 4784, 12388 and 24043.....
12388	767	Oscillating Rock Shaft Hinge Pin.....
	878J 783	“ “ “ “ “ Oil Hole Stop Screw.....
12459	773	Oscillating Rock Shaft Hinge Pin Oil Hole Stop Screw Washer (leather).....
	448c 783	Oscillating Rock Shaft Hinge Pin Set Screw.....
	4784 1353	Oscillating Rock Shaft Oil Pad.....
24045	1339	“ “ Shaft.....
24046	1341	“ “ Bushing (back).....
24047	1341	“ “ “ “ (front).....
24048	—	“ “ “ “ Crank.....
24049	1343	Oscillating Shaft Crank complete, Nos. 462c, 1636E, 24048 and 24050.....
	2269 773	Oscillating Shaft Crank Pin.....
	462c 773	“ “ “ “ Set Screw.....
19448	1353	“ “ “ “ Slide Block.....

NO.	PLATE	NAME
	229D 782	Oscillating Shaft Crank Slide Block Cap Screw.....
12424	773	Oscillating Shaft Crank Slide Block Cap Screw Washer.....
	1035c 1343	Oscillating Shaft Crank Slide Block Screw Stud.....
	1636E 1343	Oscillating Shaft Crank Slide Block Screw Stud Nut.....
24050	1343	Oscillating Shaft Crank Slide Block complete, Nos. 229D, 1035c, 12424 and 19448
12391	767	Presser Bar (hollow).....
20059	1341	“ “ Guide Bracket with 453c....
	453c 783	“ “ “ “ Set Screw....
	2062 771	“ “ Lifter.....
	689c 782	“ “ “ “ Screw.....
	1520E 783	“ “ “ “ Nut.....
	12327 770	“ “ Lifting and Releasing Lever Bracket.....
11167	767	Presser Bar Spring (light) .051 wire.....
NOTE: No. 11167 is sent with this Machine unless another Spring is specified on order		
12139	2004	Presser Bar Spring (medium) .055 wire...
20023	2004	“ “ “ (heavy) .063 wire....
11170	771	“ “ “ Washer.....
12435	780	“ Foot with 228D, for 20115, 20116, 20137, 20163 and 20164.....
NOTE: No. 12435 is sent with this Machine unless another Presser Foot is specified on order.		
12462	781	Presser Foot, $\frac{3}{8}$ in. to $\frac{1}{4}$ in. gauge.....
NOTE: When ordering No. 12462, give width of turned edge from seam.		
12463	781	Presser Foot with Strip Guide.....
12335	1308	“ “ (narrow) for 20115, 20116, 20137, 20163 and 20164.....
26276	1394	Presser Foot Hinge Pin.....
20133	—	“ “ Plate.....
19223	—	“ “ Shank.....
20134	1308	Presser Foot (hinged) complete, $\frac{3}{8}$ in. to $\frac{1}{4}$ in. gauge, Nos. 19223, 20133 and 26276.....
NOTE: When ordering No. 20134, give width of turned edge from seam.		
	2532 772	Presser Foot Hinge Pin.....
20155	—	“ “ Plate.....
20156	—	“ “ Shank.....

NO.	PLATE	NAME
20157	1309	Presser Foot (hinged) complete for 20115, 20116, 20137, 20163 and 20164, Nos. 228D, 2532, 20155 and 20156.....
20343	781	Presser Foot with guide on bottom to the right of needle hole.....
26276	1394	Presser Foot Hinge Pin.....
20360	—	“ “ Plate.....
19335	—	“ “ Shank.....
20361	781	Presser Foot (hinged) plain bottom, complete, Nos. 19335, 20360 and 26276....
26279	—	Presser Foot Extension, $\frac{1}{4}$ in., for 12435 and 20157.....
26280	—	Presser Foot Extension, $\frac{1}{8}$ in., for 12435 and 20157.....
26281	1387	Presser Foot Extension, $\frac{1}{4}$ in., for 12435 and 20157.....
26282	—	Presser Foot Extension, $\frac{3}{8}$ in., for 12435 and 20157.....
26283	—	Presser Foot Extension, $\frac{1}{2}$ in., for 12435 and 20157.....
228D	2038	Presser Foot Extension Screw.....
25967	1387	“ “ Strip Gauge for 12435 and 20157.....
228D	2038	Presser Foot Strip Gauge Screw.....
NOTE: Nos. 25967 and 26279 to 26283 are sent with this Machine unless otherwise specified on order.		
190D	782	Presser Foot Screw.....
688J	783	Pressure Regulating Thumb Screw.....
24051	1343	Shuttle Bobbin.....
15140	1353	“ “ Case Latch.....
2973	771	“ “ “ “ Lever.....
2974	771	“ “ “ “ “ Fulcrum Pin.....
2975	771	Shuttle Bobbin Case Latch Spring.....
592E	782	“ “ “ “ Stop Screw....
15141	—	Shuttle Bobbin Case Hinge, Nos. 2973, 2974 and 15140.....
24055	1343	Shuttle Bobbin Case Position Finger.....
2523	771	“ “ “ “ “ Rivet
24412	1361	“ “ “ “ Plate.....
391D	1366	“ “ “ “ “ Screw
24056	1343	Shuttle Bobbin Case complete, Nos. 591F, 592E, 2523, 2975, 15141, 24055 and 24058

NO.	PLATE	NAME
24057	1343	Shuttle Body.....
591F	782	“ Tension Regulating Screw.....
24058	1343	“ “ Spring.....
24059	1343	Shuttle, $1\frac{1}{8}$ in. diam., Nos. 24051, 24056 and 24057.....
*24060	—	Shuttle Driver.....
24061	1343	“ “ 24060 with two 462c.....
2269	773	“ “ Pin.....
462C	773	“ “ Set Screw.....
24062	1342	“ Race Back.....
2532	772	“ “ “ Position Pin.....
2533	767	“ “ “ Spring.....
907D	782	“ “ “ “ Screw.....
24437	—	“ “ Body.....
62510	—	“ “ “ 24437 with 24064 and two 1053D.....
62519	—	Shuttle Race Body 62510 with two 2532
24064	1342	“ “ Cap.....
1053D	2006	“ “ “ Screw.....
24438	1364	Shuttle Race complete, Nos. 907D, 2533, 24062, 24412, 62519 and two 391D....
145D	782	Shuttle Race Screw.....
12431	—	“ “ Slide.....
12432	2004	Shuttle Race Slide complete, Nos. 4307, 12431 and two 725E.....
4307	772	Shuttle Race Slide Spring.....
725E	1387	“ “ “ “ Screw.....
20060	1311	Slack Thread Regulator.....
225F	1323	“ “ “ Adjusting Screw
2102	5806	Tension Disc.....
1560C	783	“ Regulating Thumb Nut.....
32572	5806	“ Releasing Disc.....
43944	5806	“ “ Lever.....
12398	773	“ “ “ Hinge Pin.....
12329	772	“ “ “ Spring.....
32574	5806	“ “ Pin.....
50327C	5806	“ Screw Stud.....
44141	—	“ “ “ 50327c with 1560c... 8238 1353 “ Spring.....
24984	—	Tension complete, Nos. 7336, 8238, 24071, 32572, 32574, 44141 and two 2102....
24078	1343	Thread Guard (side of arm).....
52454	5842	“ Retainer.....
50429C	—	“ Set Screw.....
24097	1341	“ Take-up Crank.....
1037C	1341	“ “ “ Position Screw...
1036C	1341	“ “ “ Set Screw.....

NO.	PLATE	NAME
24068	1341	Thread Take-up Lever.....
12166	773	" " " Hinge Pin.....
24099	1341	" " " Link.....
11204	770	" " " " Hinge Pin...
435c	5806	" " " " " " Set Screw.....
24070	—	Thread Take-up Lever complete, Nos. 12166, 24068 and 24099.....
24071	1343	Thread Take-up Spring.....
7336	772	" " " Regulator.....
448c	783	" " " " Set Screw
20123	1266	Throat Plate for 20115, 20116, 20137, 20163 and 20164.....

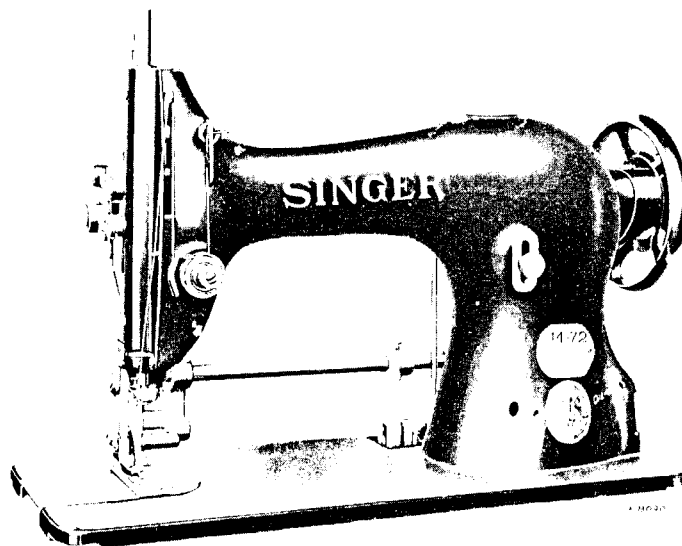
NOTE: No. 20123 is sent with this Machine unless another Throat Plate is specified on order.

691F	782	Throat Plate Screw.....
24079	2644	Drip Pan with four 1 in. wire nails.....

SPOOL HOLDER (Disc)

26763	1352	Bracket with 219F and 287D.....
219F	774	" Screw.....
287D	2636	" Thumb Screw.....
19066	1352	Spindle.....
19067	1352	" Thread Guiding Disc.....
691F	782	" " " " Screw.....
26764	1352	Spool Holder (disc) complete, Nos. 691F, 19066, 19067 and 26763.....

LIST OF PARTS COMPLETE FOR



MACHINE No. 44-72

FOR BINDING CORSETS AND OTHER ARTICLES; ALSO FOR
STITCHING WORK OF UNEVEN THICKNESS OR HAVING
ADHESIVE SURFACES. HAS POSITIVE UPPER AND UNDER
FEEDING MECHANISM AND ALTERNATING PRESSERS.

NO.	PLATE	NAME
*24469	—	Arm with 11104.....
8582	773	" Dowel Pin.....
12453	773	" Oil Tube, for intermediate bearing..
12454	773	" " " with 29599, for oiling 12409
11119	773	" " " " " " " 12408 and 19365.....
24131	2014	Arm Oil Tube with 29599, for oiling 20283
29599	2014	" " " Packing (felt).....
748E	782	" Screw (back).....
868E	1366	" " (front).....
16511	1349	" Shaft.....
*11104	—	" " Bushing (front).....
12357	767	" " Flanged Bushing (back).....

NO.	PLATE	NAME
448c	783	Arm Shaft Flanged Bushing (back) Set Screw.....
144D	782	Arm Shaft Screw.....
12193	2004	" Side Cover.....
286D	783	" " " Thumb Screw.....
12403	772	" Spool Pin and Thread Eyelet.....
11241	2003	" " " Washer (cloth).....
24296	1348	Balance Wheel (power) light rim, 2 $\frac{3}{8}$ in. pulley, with two 448c.....
24297	1340	Balance Wheel Oil Cover.....
210D	1343	" " " " Screw.....
448c	783	" " " Set Screw.....
*24470	—	Bed.....
20197	1350	Crank Connecting Rod with 20198 and two 896E.....
*20198	—	Crank Connecting Rod Cap.....
896E	773	" " " " Screw.....
908c	773	" " " Hinge Screw.....
1619E	773	" " " " " Nut.
19354	—	Face Plate.....
19355	1311	Face Plate complete, Nos. 2827, 12150 and 19354.....
219D	774	Face Plate Screw.....
44181	—	" " Thread Guard (lower).....
12150	773	" " " " " 44181 with 12152.....
12152	773	Face Plate Thread Guard (lower) Rivet....
2827	773	" " " " (upper) with 8505
8505	773	" " " " " Rivet....
12368	767	Feed Bar (lower).....
313c	783	" " " Screw Centre.....
56813	—	" " " " " 313c with 1519J.....
1519J	783	Feed Bar (lower) Screw Centre Nut.....
24471	2688	" " (upper).....
19367	1313	" " " Cap.....
199D	1312	" " " " Screw for 24901....
219D	774	" " " " " 19367....
3033	770	" Connecting Link.....
375c	782	" " " Hinge Screw.....
1518E	783	" " " " " Nut.
24344	1267	" Dog.....
208E	782	" " Screw.....
20283	1315	" and Feed Lifting Eccentric with 446c
446c	783	" " " " " Set Screw
24036	1340	" " " " " Sleeve...
20284	1350	" Forked Connection.....

NO.	PLATE	NAME
375c	782	Feed Forked Connection Hinge Screw...
1518E	783	" " " " " Nut
24969	2551	" Lifting Rock Shaft.....
24970	—	Feed Lifting Rock Shaft complete, Nos. 12376 and 24969.....
12376	770	Feed Lifting Rock Shaft Crank with 157J and 1813.....
157J	782	Feed Lifting Rock Shaft Crank Clamping Screw.....
1813	783	Feed Lifting Rock Shaft Crank Roller and Stud.....
43976	2551	Feed Lifting Rock Shaft Crank Connecting Rod with 43977 and two 966E.....
*43977	—	Feed Lifting Rock Shaft Crank Connecting Rod Cap.....
966E	5806	Feed Lifting Rock Shaft Crank Connecting Rod Cap Screw.....
375c	782	Feed Lifting Rock Shaft Crank Connecting Rod Hinge Screw.....
1518E	783	Feed Lifting Rock Shaft Crank Connecting Rod Hinge Screw Nut.....
307c	783	Feed Lifting Rock Shaft Screw Centre...
56814	—	" " " " " 307c with 1513J.....
1513J	783	Feed Lifting Rock Shaft Screw Centre Nut
3039	768	" Regulator.....
1128E	2009	" " Hinge Screw.....
818D	783	" " Thumb Screw.....
24472	2687	" Rock Shaft.....
24473	—	Feed Rock Shaft complete, Nos. 20247, 24472 and 29633.....
29633	1354	Feed Rock Shaft Crank with 157J.....
157J	782	" " " " Clamping Screw.
307c	783	" " " Screw Centre.....
56814	—	" " " " " 307c with 1513J.....
1513J	783	Feed Rock Shaft Screw Centre Nut.....
24549	8379	" (upper) Shaft.....
20249	2687	" " " Bracket (back).....
134D	2688	" " " " " Screw
24475	2687	" " " " (front).....
171D	2688	" " " " " Screw
20251	2688	" " " Collar with 456c.....
456c	2688	" " " " Set Screw.....
20254	2687	Feed (upper) Shaft Crank (back) with 191c.....

NO.	PLATE	NAME
2049	773	Feed (upper) Shaft Crank (back) Pin . . .
191c	1366	" " " " " Set Screw
24476	2687	" " " " (front) with two 460c and four 454c
62674	—	Feed (upper) Shaft Crank (front) 24476 with 24477 and 24479
24477	2687	Feed (upper) Shaft Crank (front) Con- nection
24550	8375	Feed (upper) Shaft Crank (front) Con- nection Hinge Pin
1019F	2688	Feed (upper) Shaft Crank (front) Con- nection Hinge Pin Set Screw
24479	2688	Feed (upper) Shaft Crank (front) Hinge Pin
460c	2688	Feed (upper) Shaft Crank (front) Hinge Pin Set Screw
454c	2688	Feed (upper) Shaft Crank (front) Set Screw
20247	2687	Feed (upper) Shaft Regulator Crank with 1518E, 1942 and two 190D
190D	2688	Feed (upper) Shaft Regulator Crank Clamping Screw
1904	770	Feed (upper) Shaft Regulator Crank Roller (roller only)
1942	2688	Feed (upper) Shaft Regulator Crank Roller and Screw Stud with 229D, 1904 and 12424
1518E	2688	Feed (upper) Shaft Regulator Crank Roller and Screw Stud Nut
229D	2688	Feed (upper) Shaft Regulator Crank Roller Cap Screw
12424	2688	Feed (upper) Shaft Regulator Crank Roller Cap Screw Washer
24480	2688	Feeding Foot, 16 teeth to the inch, with two 1019F
24725	8375	Feeding Foot, 36 teeth to the inch, with two 1019F
217D	2688	Feeding Foot Screw
12391	767	Lifting Presser Bar (hollow)
19356	1312	" " " Bell Crank
199D	1312	" " " " " Cap Screw
19357	1312	" " " " " Connecting Link
199D	1312	Lifting Presser Bar Bell Crank Connecting Link Cap Screw
24351	1354	Lifting Presser Bar Bell Crank Driving Arm

NO.	PLATE	NAME
19362	1313	Lifting Presser Bar Bell Crank Driving Arm Eccentric Connection
375c	782	Lifting Presser Bar Bell Crank Driving Arm Eccentric Connection Hinge Screw
1518E	783	Lifting Presser Bar Bell Crank Driving Arm Eccentric Connection Hinge Screw Nut
2049	773	Lifting Presser Bar Bell Crank Driving Arm Pin
19359	1312	Lifting Presser Bar Bell Crank Driving Arm Shaft
19360	1311	Lifting Presser Bar Bell Crank Driving Arm Shaft Bracket
24352	—	Lifting Presser Bar Bell Crank Driving Arm Shaft Bracket complete, Nos. 2049, 19359, 19360 and 24351
965D	1312	Lifting Presser Bar Bell Crank Driving Arm Shaft Bracket Screw
24589	5736	Lifting Presser Bar Guide Bracket with 453c
24901	—	Lifting Presser Bar Guide Bracket 24589 with 19356, 19357, 24471 and three 199D
453c	783	Lifting Presser Bar Guide Bracket Set Screw
24590	5736	Lifting Presser Bar Guide Bracket Support
175D	5736	" " " " " " " Screw
20240	8375	Lifting Presser Bar Lifter
689c	782	" " " " " Screw
1520E	783	" " " " " Nut
12327	770	" " " " " Lifting and Releasing Lever Bracket
11167	767	Lifting Presser Bar Spring (light) .051 wire
NOTE: No. 11167 is sent with this Machine unless another Spring is specified on order.		
12139	2004	Lifting Presser Bar Spring (medium) .055 wire
20023	2004	Lifting Presser Bar Spring (heavy) .063 wire
11170	771	Lifting Presser Bar Spring Washer
24481	2688	" " " Foot
193D	2688	" " " " " Screw
19229	2004	Needle Bar (hollow) for high lift
12382	770	" " " Connecting Link with 794E

NO.	PLATE	NAME
794E	782	Needle Bar Connecting Link Adjusting Screw.....
*12383	—	Needle Bar Connecting Stud.....
1904	770	“ “ “ “ Roller (roller only).....
453C	783	Needle Bar Connecting Stud Set Screw...
12384	770	Needle Bar Connecting Stud complete, Nos. 453c, 1904 and 12383.....
19365	1311	Needle Bar Crank and Lifting Eccentric with 448c and 743c.....
743c	1313	Needle Bar Crank and Lifting Eccentric Position Screw.....
448c	783	Needle Bar Crank and Lifting Eccentric Set Screw.....
936E	773	Needle Bar Screw Bushing.....
24101	—	“ Clamp Body.....
808F	782	“ “ Screw.....
24102	1353	“ “ Thread Guide.....
651D	1353	“ “ “ “ Screw.....
24103	1353	Needle Clamp (high lift) complete, Nos. 651D, 808F, 24101 and 24102.....
24104	1350	Oscillating Rock Shaft.....
24105	—	Oscillating Rock Shaft complete, Nos. 4784, 12388 and 24104.....
12388	767	Oscillating Rock Shaft Hinge Pin.....
878J	783	“ “ “ “ “ Oil Hole Stop Screw.....
12459	773	Oscillating Rock Shaft Hinge Pin Oil Hole Stop Screw Washer (leather).....
448c	783	Oscillating Rock Shaft Hinge Pin Set Screw.....
4784	1353	Oscillating Rock Shaft Oil Pad.....
16509	766	“ Shaft.....
19496	—	“ “ Crank for 19447.....
44134	—	“ “ “ “ 44135.....
19447	1353	Oscillating Shaft Crank complete, Nos. 457c, 1518E, 19449 and 19496.....
44135	5806	Oscillating Shaft Crank complete, Nos. 1518E, 19449, 44134 and two 453c....
2049	773	Oscillating Shaft Crank Pin.....
457c	783	“ “ “ Set Screw for 19447.....
453c	783	“ “ “ “ “ 44135.....
19448	1353	“ “ “ “ Slide Block.....
229D	782	“ “ “ “ “ Cap Screw.....
12424	773	Oscillating Shaft Crank Slide Block Cap Screw Washer.....

NO.	PLATE	NAME
988c	1353	Oscillating Shaft Crank Slide Block Screw Stud.....
1518E	783	Oscillating Shaft Crank Slide Block Screw Stud Nut.....
19449	1353	Oscillating Shaft Crank Slide Block complete, Nos. 229D, 988c, 12424 and 19448.....
688J	783	Pressure Regulating Thumb Screw.....
2996	771	Shuttle Bobbin.....
15140	1353	“ “ Case Latch.....
2973	771	“ “ “ “ Lever.....
2974	771	“ “ “ “ “ Fulcrum Pin.....
2975	771	Shuttle Bobbin Case Latch Spring.....
592E	782	“ “ “ “ Stop Screw...
15141	—	Shuttle Bobbin Case Hinge, Nos. 2973, 2974 and 15140.....
7553	771	Shuttle Bobbin Case Position Finger.....
2523	771	“ “ “ “ “ Rivet.....
24412	1361	“ “ “ “ “ Plate.....
391D	1366	“ “ “ “ “ Screw.....
24074	771	Shuttle Bobbin Case complete, Nos. 591F, 592E, 2523, 2975, 7553, 15098 and 15141.....
12393	771	Shuttle Body.....
591F	782	“ Tension Regulating Screw.....
15098	771	“ “ Spring.....
19292	771	Shuttle, 1 $\frac{1}{16}$ in. diam., Nos. 2996, 12393 and 24074.....
*12394	—	Shuttle Driver.....
12444	771	“ “ 12394 with two 1266c....
2049	773	“ “ Pin.....
1266c	5806	“ “ Set Screw.....
2531	767	“ Race Back.....
2532	772	“ “ “ Position Pin.....
2533	767	“ “ “ Spring.....
907D	782	“ “ “ “ Screw.....
24413	—	“ “ Body.....
25000	—	“ “ “ 24413 with 24414 and two 1053D.....
24414	1362	Shuttle Race Cap.....
1053D	2006	“ “ “ Screw.....
24415	1361	Shuttle Race complete, Nos. 907D, 2531, 2533, 24412, 25000 and two each 391D and 2532.....
145D	782	Shuttle Race Screw.....
12431	—	“ “ Slide.....
12432	2004	Shuttle Race Slide complete, Nos. 4307, 12431 and two 725E.....

NO.	PLATE	NAME
4307	772	Shuttle Race Slide Spring
725E	1387	" " " " Screw
2102	5806	Tension Disc
1560c	783	" Regulating Thumb Nut
32572	5806	" Releasing Disc
43944	5806	" " Lever
12398	773	" " " Hinge Pin
12329	772	" " " Spring
32574	5806	" " Pin
50327c	5806	" Screw Stud
44141	—	" " " 50327c with 1560c
43945	5806	" Spring
12149	2014	" Thread Guard
44118	—	Tension complete, Nos. 7336, 32572, 32574, 43945, 43946, 44141 and two 2102
52454	5842	Thread Retainer
50429c	—	" " Set Screw
12404	770	" Take-up Crank
3094	773	" " " Wedge
690E	782	" " " " Screw
12408	770	" " Lever
775E	782	" " " Cap Screw
12166	773	" " " Hinge Pin
12409	770	" " " Link
11204	770	" " " " Hinge Pin
435c	5806	" " " " " " Set Screw
12410	—	Thread Take-up Lever complete, Nos. 12166, 12408 and 12409
43946	5806	Thread Take-up Spring
7336	772	" " " Regulator
448c	783	" " " " Set Screw
24353	1267	Throat Plate, large needle hole, for 24344
24354	—	" " small needle hole, for 24344
691F	782	" " Screw
24079	2644	Drip Pan with four 1 in. wire nails

LIST OF PARTS COMPLETE

FOR

MACHINE No. 44-74

FOR REPAIRING BELTS IN COTTON MILLS, ETC. HAS HAND
DRIVING ATTACHMENT, DROP FEED.

NO.	PLATE	NAME
*16501	—	Arm with 11104
8582	773	" Dowel Pin
12453	773	" Oil Tube for intermediate bearing
12454	773	" " " with 29599, for oiling 12409
11119	773	" " " " " " " 12108
24131	2014	" " " " " " " 20283
29599	2014	" " " Packing (felt)
748E	782	" Screw (back)
868E	1366	" " (front)
16511	1349	" Shaft
*11104	—	" " Bushing (front)
12357	767	" " Flanged Bushing (back)
448c	783	" " " " " " Set Screw
144D	782	Arm Shaft Screw
12480	767	" Side Cap
219D	774	" " " Screw
12193	2001	" " Cover
286D	783	" " " Thumb Screw
12403	772	" Spool Pin and Thread Eyelet
11241	2003	" " " Washer (cloth)
4370	1348	Balance Wheel (power) heavy rim, 2 $\frac{3}{4}$ in. pulley, with two 448c
24297	1340	Balance Wheel Oil Cover
210D	1343	" " " " Screw
448c	783	" " " Set Screw
*16503	—	Bed
20197	1350	Crank Connecting Rod with 20198 and two 896E
*20198	—	Crank Connecting Rod Cap
896E	773	" " " " Screw
908c	773	" " " " Hinge Screw
1619E	773	" " " " " Nut
20057	—	Face Plate
20058	1340	Face Plate complete, Nos. 2827, 12150 and 20057

NO.	PLATE	NAME
190D	782	Face Plate Screw.....
44181	—	“ “ Thread Guard (lower).....
12150	773	“ “ “ “ “ 44181 with 12152.....
12152	773	Face Plate Thread Guard (lower) Rivet... 2827 773 “ “ “ “ (upper) with 8505 8505 773 “ “ “ “ “ Rivet....
286D	783	“ “ Thumb Screw.....
12368	767	Feed Bar.....
313C	783	“ “ Screw Centre.....
56813	—	“ “ “ “ 313c with 1519J..
1519J	783	“ “ “ “ Nut.....
3033	770	“ Connecting Link.....
375C	782	“ “ “ Hinge Screw.....
1518E	783	“ “ “ “ “ Nut..
12369	776	“ Dog, 12 teeth (12 teeth to the inch)
208E	782	“ “ Screw.....
20283	1315	“ and Feed Lifting Eccentric with 446C
446C	783	“ “ “ “ “ Set Screw
24036	1340	“ “ “ “ “ Sleeve...
20284	1350	“ Forked Connection.....
375C	782	“ “ “ Hinge Screw...
1518E	783	“ “ “ “ “ Nut
24969	2551	“ Lifting Rock Shaft.....
24970	—	Feed Lifting Rock Shaft complete, Nos. 12376 and 24969.....
12376	770	Feed Lifting Rock Shaft Crank with 157J and 1813.....
157J	782	Feed Lifting Rock Shaft Crank Clamping Screw.....
1813	783	Feed Lifting Rock Shaft Crank Roller and Stud.....
43976	2551	Feed Lifting Rock Shaft Crank Connect- ing Rod with 43977 and two 966E.....
*43977	—	Feed Lifting Rock Shaft Crank Connect- ing Rod Cap.....
966E	5806	Feed Lifting Rock Shaft Crank Connect- ing Rod Cap Screw.....
375C	782	Feed Lifting Rock Shaft Crank Connect- ing Rod Hinge Screw.....
1518E	783	Feed Lifting Rock Shaft Crank Connect- ing Rod Hinge Screw Nut.....
307C	783	Feed Lifting Rock Shaft Screw Centre... 56814 — “ “ “ “ “ “ 307c with 1513J.....
1513J	783	Feed Lifting Rock Shaft Screw Centre Nut
3039	768	“ Regulator.....

NO.	PLATE	NAME
1128E	2009	Feed Regulator Hinge Screw.....
818D	783	“ “ Thumb Screw.....
16506	766	“ Rock Shaft.....
24376	—	Feed Rock Shaft complete, Nos. 16506 and 29633.....
29633	1354	Feed Rock Shaft Crank with 157J.....
157J	782	“ “ “ “ Clamping Screw
307C	783	“ “ “ Screw Centre.....
56814	—	“ “ “ “ “ 307c with 1513J.....
1513J	783	Feed Rock Shaft Screw Centre Nut.....
94002	8377	Hand Attachment Body.....
24797	8377	“ “ “ Bracket with 453c
183D	8378	“ “ “ “ Screw...
80023	8377	“ “ Crank Handle (wood)
94012	8377	“ “ “ “ Spindle
8280	8378	“ “ “ Hinge Pin.....
8435	8377	“ “ “ Lever.....
94005	—	Hand Attachment Crank complete, Nos. 8435, 80023 and 94012.....
8281	8378	Hand Attachment Crank Lock Pin.....
8282	8378	“ “ “ “ Spring
8313	8377	“ “ Driver.....
62632	—	Hand Attachment Driver 8313 with 240B, 8285, 8286 and 24798.....
62676	—	Hand Attachment Driver 62632 with 2532 and 8394.....
24798	8378	Hand Attachment Driver Finger.....
8285	8378	“ “ “ “ Hinge Pin
8286	8378	“ “ “ “ Lock Spring.....
240B	8378	Hand Attachment Driver Finger Lock Spring Screw.....
8392	8377	Hand Attachment Gear with 8281 and 8282.....
94011	8377	Hand Attachment Gear Cover.....
211A	8378	“ “ “ “ Screw....
659D	8378	“ “ “ Screw Stud.....
8394	8378	“ “ Pinion.....
2532	8378	“ “ “ Dowel Pin....
660D	8378	“ “ “ Screw Stud....
15072	2014	Bobbin Winder Bobbin Position Pin.....
24799	8377	“ “ Frame.....
24800	—	Bobbin Winder Frame complete, Nos. 333D, 5960, 5961, 5963, 24799 and 24802

NO.	PLATE	NAME
24801	8378	Bobbin Winder Frame Hinge Stud
453c	8378	" " " " " Set Screw
5960	768	Bobbin Winder Friction Wheel (leather) . .
5961	768	" " " " Washer
333D	8378	" " " " Screw
24802	8378	" " Spindle with 15072
5963	768	" " " Flange
24803	8377	" " Stop Latch
24804	8377	" " " " Arm with 453c
453c	8378	" " " " " Set Screw
1317D	8378	" " " " " Thumb Screw
32D	8378	Bobbin Winder Stop Latch Hinge Screw . .
24805	8378	" " Tension Bracket
2455	8378	" " " Disc
15367	8378	" " " " Spring
2457	8378	" " " " Stud
24806	8378	Bobbin Winder Tension Bracket complete, Nos. 2455, 2457, 15367 and 24805
205D	8378	Bobbin Winder Tension Bracket Screw . .
*62587	---	Hand Attachment complete with Bobbin Winder, Nos. 32D, 659D, 660D, 1317D, 8280, 8392, 24797, 24800, 24801, 24803, 24804, 62676, 94002, 94005, 94011 and two each 183D and 211A
24807	---	Hand Attachment complete with Bobbin Winder, Nos. 205D, 692D, 24806 and 62587
692D	783	Hand Attachment Screw
12381	767	Needle Bar (hollow)
12382	770	" " Connecting Link with 794E
794E	782	" " " " Adjusting Screw
*12383	---	Needle Bar Connecting Stud
1904	770	" " " " Roller (roller only)
453c	783	Needle Bar Connecting Stud Set Screw . .
12384	770	Needle Bar Connecting Stud complete, Nos. 453c, 1904 and 12383
20188	767	Needle Bar Crank with 858c and 1065c . .
1065c	1366	" " " Position Screw
858c	783	" " " Set Screw
936E	773	" " Screw Bushing
4302	773	" " Thread Guard
233D	782	" " " " Screw
4303	773	" Clamp with 808F

NO.	PLATE	NAME
808F	782	Needle Clamp Screw
24104	1350	Oscillating Rock Shaft
24105	---	Oscillating Rock Shaft complete, Nos. 4784, 12388 and 24104
12388	767	Oscillating Rock Shaft Hinge Pin
878J	783	" " " " Oil Hole Stop Screw
12459	773	Oscillating Rock Shaft Hinge Pin Oil Hole Stop Screw Washer (leather)
448c	783	Oscillating Rock Shaft Hinge Pin Set Screw
4784	1353	Oscillating Rock Shaft Oil Pad
16509	766	" Shaft
19496	---	" " Crank for 19447
44134	---	" " " " 44135
19447	1353	Oscillating Shaft Crank complete, Nos. 457c, 1518E, 19449 and 19496
44135	5806	Oscillating Shaft Crank complete, Nos. 1518E, 19449, 44134 and two 453c
2049	773	Oscillating Shaft Crank Pin
457c	783	" " " Set Screw for 19447
453c	783	" " " " " 44135
19448	1353	" " " Slide Block
229D	782	" " " " Cap Screw
12424	773	Oscillating Shaft Crank Slide Block Cap Screw Washer
988c	1353	Oscillating Shaft Crank Slide Block Screw Stud
1518E	783	Oscillating Shaft Crank Slide Block Screw Stud Nut
19449	1353	Oscillating Shaft Crank Slide Block complete, Nos. 229D, 988c, 12424 and 19448
12391	767	Presser Bar (hollow)
20059	1341	" " Guide Bracket with 453c
453c	783	" " " " Set Screw
2062	771	" " Lifter
689c	782	" " " Screw
1520E	783	" " " Nut
12327	770	" " Lifting and Releasing Lever Bracket
11167	767	Presser Bar Spring (light) .051 wire

NOTE: No. 11167 is sent with this Machine unless another Spring is specified on order.

12139	2004	Presser Bar Spring (medium) .055 wire . . .
20023	2004	" " " (heavy) .063 wire
11170	771	" " " Washer

NO.	PLATE	NAME
12143	780	Presser Foot for 12369.....
190D	782	“ “ Screw.....
688J	783	Pressure Regulating Thumb Screw.....
19131	5737	Shuttle Bobbin.....
20649	5737	“ “ Case Latch.....
2973	5737	“ “ “ “ Lever.....
2974	5737	“ “ “ “ “ Fulcrum Pin.....
2975	5737	Shuttle Bobbin Case Latch Spring.....
592E	5737	“ “ “ “ Stop Screw....
20650	—	Shuttle Bobbin Case Hinge, Nos. 2973, 2974 and 20649.....
20755	5737	Shuttle Bobbin Case Position Finger.....
2523	5737	“ “ “ “ “ Rivet
24323	2046	“ “ “ “ Plate.....
391D	1366	“ “ “ “ “ Screw
20756	5737	Shuttle Bobbin Case complete, Nos. 591F, 592E, 2523, 2975, 20650, 20654 and 20755.....
20757	5737	Shuttle Body.....
591F	5737	“ Tension Regulating Screw.....
20654	5737	“ “ Spring.....
20758	5737	Shuttle, 1 $\frac{1}{8}$ in. diam., Nos. 19131, 20756 and 20757.....
19406	2012	Shuttle Driver with two 1266c.....
2049	773	“ “ Pin.....
1266c	5806	“ “ Set Screw.....
2419	2006	“ Race Back.....
2532	772	“ “ “ Position Pin.....
2533	767	“ “ “ Spring.....
907D	782	“ “ “ “ Screw.....
24324	—	“ “ Body.....
24998	—	“ “ “ 24324 with 24009 and two 1053D.....
24009	2006	Shuttle Race Cap.....
1053D	2006	“ “ “ Screw.....
24325	2046	Shuttle Race complete, Nos. 907D, 2419, 2533, 24323, 24998 and two each 391D and 2532.....
145D	782	Shuttle Race Screw.....
12431	—	“ “ Slide.....
12432	2004	Shuttle Race Slide complete, Nos. 4307, 12431 and two 725E.....
4307	772	Shuttle Race Slide Spring.....
725E	1387	“ “ “ “ Screw.....
20060	1311	Slack Thread Regulator.....
225F	1323	“ “ “ Adjusting Screw

NO.	PLATE	NAME
2102	5806	Tension Disc.....
1560c	783	“ Regulating Thumb Nut.....
32572	5806	“ Releasing Disc.....
43944	5806	“ “ Lever.....
12398	773	“ “ “ Hinge Pin.....
12329	772	“ “ “ Spring.....
32574	5806	“ “ Pin.....
50327c	5806	“ Screw Stud.....
44141	—	“ “ “ 50327c with 1560c..
43945	5806	“ Spring.....
44118	—	Tension complete, Nos. 7336, 32572, 32574, 43945, 43946, 44141 and two 2102
52454	5842	Thread Retainer.....
50429c	—	“ “ Set Screw.....
12404	770	“ Take-up Crank.....
3094	773	“ “ “ Wedge.....
690E	782	“ “ “ “ Screw....
12408	770	“ “ Lever.....
775E	782	“ “ “ Cap Screw.....
12166	773	“ “ “ Hinge Pin.....
12409	770	“ “ “ Link.....
11204	770	“ “ “ “ Hinge Pin....
435c	5806	“ “ “ “ “ “ Set Screw.....
12410	—	Thread Take-up Lever complete, Nos. 12166, 12408 and 12409.....
43946	5806	Thread Take-up Spring.....
7336	772	“ “ “ Regulator.....
448c	783	“ “ “ “ Set Screw
12411	776	Throat Plate, large needle hole, for 12369
NOTE: No. 12411 is sent with this Machine unless another Throat Plate is specified on order.		
12449	—	Throat Plate, small needle hole, for 12369
691F	782	“ “ Screw.....
24079	2644	Drip Pan with four 1 in. wire nails.....

**LIST OF PARTS COMPLETE
FOR
MACHINE No. 44-75**

**FOR BANDING APRONS, ETC. HAS POSITIVE RUFFLING
MECHANISM AND FOLDER. FOR FOLDING THE BAND,
INSERTING AND FULLING IN THE BODY OF THE GARMENT
IN ONE OPERATION. DROP FEED.**

NO.	PLATE	NAME
*62548	—	Arm with 11104.....
8582	773	" Dowel Pin.....
12453	773	" Oil Tube for intermediate bearing...
12454	773	" " " with 29599, for oiling 12409
11119	773	" " " " " " " 12408
24131	2014	" " " " " " " 20283
29599	2014	" " " Packing (felt).....
748E	782	" Screw (back).....
868E	1366	" " (front).....
16511	1349	" Shaft.....
*11104	—	" " Bushing (front).....
12357	767	" " Flanged Bushing (back).....
448C	783	" " " " " " S e t Screw.....
144D	782	Arm Shaft Screw.....
12193	2004	" Side Cover.....
286D	783	" " " Thumb Screw.....
12403	772	" Spool Pin and Thread Eyelet.....
11241	2003	" " " Washer (cloth).....
24296	1348	Balance Wheel (power) light rim, 2 $\frac{3}{8}$ in. pulley, with two 448c.....
24297	1340	Balance Wheel Oil Cover.....
210D	1343	" " " " Screw.....
448C	783	" " Set Screw.....
*24470	—	Bed.....
20197	1350	Crank Connecting Rod with 20198 and two 896E.....
*20198	—	Crank Connecting Rod Cap.....
896E	773	" " " " Screw.....
908C	773	" " " Hinge Screw.....
1619E	773	" " " " " Nut
19354	—	Face Plate.....
19355	1311	Face Plate complete, Nos. 2827, 12150 and 19354.....

NO.	PLATE	NAME
219D	774	Face Plate Screw.....
44181	—	" " Thread Guard (lower).....
12150	773	" " " " " 44181 with 12152.....
12152	773	Face Plate Thread Guard (lower) Rivet...
2827	773	" " " " (upper) with 8505
8505	773	" " " " " Rivet....
12368	767	Feed Bar (lower).....
313C	783	" " " Screw Centre.....
56813	—	" " " " " 313c with 1519r.....
1519r	783	Feed Bar (lower) Screw Centre Nut.....
1519j	783	Feed Bar (lower) Screw Centre Nut.....
24471	2688	" " (upper).....
19367	1313	" " " Cap.....
199D	1312	" " " " Screw for 24901...
219D	774	" " " " " 19367...
3033	770	" Connecting Link.....
375c	782	" " " Hinge Screw.....
1518E	783	" " " " " Nut...
62549	8376	" Dog.....
208E	782	" " Screw.....
20283	1315	" and Feed Lifting Eccentric with 446c
446c	783	" " " " " Set Screw
24036	1340	" " " " " Sleeve...
20284	1350	" Forked Connection.....
375c	782	" " " Hinge Screw...
1518E	783	" " " " " Nut
24969	2551	" Lifting Rock Shaft.....
24970	—	Feed Lifting Rock Shaft complete, Nos. 12376 and 24969.....
12376	770	Feed Lifting Rock Shaft Crank with 157j and 1813.....
157j	782	Feed Lifting Rock Shaft Crank Clamping Screw.....
1813	783	Feed Lifting Rock Shaft Crank Roller and Stud.....
43976	2551	Feed Lifting Rock Shaft Crank Connect- ing Rod with 43977 and two 966E.....
*43977	—	Feed Lifting Rock Shaft Crank Connect- Rod Cap.....
966E	5806	Feed Lifting Rock Shaft Crank Connect- Rod Cap Screw.....
375c	782	Feed Lifting Rock Shaft Crank Connect- ing Rod Hinge Screw.....
1518E	783	Feed Lifting Rock Shaft Crank Connect- ing Rod Hinge Screw Nut.....

NO.	PLATE	NAME
307c	783	Feed Lifting Rock Shaft Screw Centre...
56814	—	“ “ “ “ “ “ 307c with 1513j.....
1513j	783	Feed Lifting Rock Shaft Screw Centre Nut
3039	768	“ Regulator.....
1128E	2009	“ “ Hinge Screw.....
818D	783	“ “ Thumb Screw.....
24472	2687	“ Rock Shaft.....
24473	—	Feed Rock Shaft complete, Nos. 20247, 24472 and 29633.....
29633	1354	Feed Rock Shaft Crank with 157j.....
157j	782	“ “ “ “ Clamping Screw.
307c	783	“ “ “ Screw Centre.....
56814	—	“ “ “ “ “ “ 307c with 1513j.....
1513j	783	Feed Rock Shaft Screw Centre Nut.....
62599	8379	“ (upper) Shaft.....
20249	2687	“ “ “ Bracket.....
134D	2688	“ “ “ “ Screw.....
20251	2688	“ “ “ Collar with 456c.....
456c	2688	“ “ “ “ Set Screw.....
20254	2687	“ “ “ Crank (back) with 191c
2049	773	“ “ “ “ Pin.....
191c	1366	“ “ “ “ “ Set Screw
62615	8379	“ “ “ “ (front) with four 454c.....
62550	8379	Feed (upper) Shaft Crank (front) Conne- ction with two 452c.....
62551	8380	Feed (upper) Shaft Crank (front) Conne- ction Hinge Pin.....
460c	2688	Feed (upper) Shaft Crank (front) Conne- ction Hinge Pin Set Screw.....
452c	8380	Feed (upper) Shaft Crank (front) Conne- ction Set Screw.....
24479	2688	Feed (upper) Shaft Crank (front) Hinge Pin.....
454c	2688	Feed (upper) Shaft Crank (front) Set Screw.....
20247	2687	Feed (upper) Shaft Regulator Crank with 1518E, 1942 and two 190D.....
190D	2688	Feed (upper) Shaft Regulator Crank Clamping Screw.....
1904	770	Feed (upper) Shaft Regulator Crank Roller (roller only).....
1942	2688	Feed (upper) Shaft Regulator Crank Roller and Screw Stud with 229D, 1904 and 12424.....

NO.	PLATE	NAME
1518E	2688	Feed (upper) Shaft Regulator Crank Roller and Screw Stud Nut.....
229D	2688	Feed (upper) Shaft Regulator Crank Roller Cap Screw.....
12424	2688	Feed (upper) Shaft Regulator Crank Roller Cap Screw Washer.....
62552	8380	Feeding Foot (upper) with two 460c.....
217D	2688	“ “ Screw.....
12391	767	Lifting Presser Bar (hollow).....
19356	1312	“ “ “ Bell Crank.....
199D	1312	“ “ “ “ “ Cap Screw.
19357	1312	“ “ “ “ “ Connecting Link.....
199D	1312	Lifting Presser Bar Bell Crank Connecting Link Cap Screw.....
24351	1354	Lifting Presser Bar Bell Crank Driving Arm.....
62553	8379	Lifting Presser Bar Bell Crank Driving Arm Eccentric Connection.....
375c	782	Lifting Presser Bar Bell Crank Driving Arm Eccentric Connection Hinge Screw
1518E	783	Lifting Presser Bar Bell Crank Driving Arm Eccentric Connection Hinge Screw Nut.....
2049	773	Lifting Presser Bar Bell Crank Driving Arm Pin.....
19359	1312	Lifting Presser Bar Bell Crank Driving Arm Shaft.....
62554	8379	Lifting Presser Bar Bell Crank Driving Arm Shaft Bracket.....
62555	—	Lifting Presser Bar Bell Crank Driving Arm Shaft Bracket complete, Nos. 2049, 19359, 24351 and 62554.....
965D	1312	Lifting Presser Bar Bell Crank Driving Arm Shaft Bracket Screw.....
24589	5736	Lifting Presser Bar Guide Bracket with 453c.....
24901	—	Lifting Presser Bar Guide Bracket 24589 with 19356, 19357, 24471 and three 199D
453c	783	Lifting Presser Bar Guide Bracket Set Screw.....
62600	8379	Lifting Presser Bar Guide Bracket Support
175D	5736	“ “ “ “ “ “ “ Screw.....
62556	8376	Lifting Presser Bar Lifter.....
689C	782	“ “ “ “ “ Screw.....
1520E	783	“ “ “ “ “ Nut.....

NO.	PLATE	NAME
12327	770	Lifting Presser Bar Lifting and Releasing Lever Bracket.....
11167	767	Lifting Presser Bar Spring (light) .051 wire
NOTE: No. 11167 is sent with this Machine unless another Spring is specified on order.		
12139	2004	Lifting Presser Bar Spring (medium) .055 wire.....
20023	2004	Lifting Presser Bar Spring (heavy) .063 wire.....
11170	771	Lifting Presser Bar Spring Washer.....
62557	8380	" " Foot.....
190D	782	" " " Screw.....
19229	2004	Needle Bar (hollow) for high lift.....
12382	770	" " Connecting Link with 794E..
794E	782	" " " " Adjusting Screw.....
*12383	—	Needle Bar Connecting Stud.....
1904	770	" " " " Roller (roller only).....
453c	783	Needle Bar Connecting Stud Set Screw...
12384	770	Needle Bar Connecting Stud complete, Nos. 453c, 1904 and 12383.....
62558	8379	Needle Bar Crank and Lifting Eccentric with 448c and 743c.....
743c	1313	Needle Bar Crank and Lifting Eccentric Position Screw.....
448c	783	Needle Bar Crank and Lifting Eccentric Set Screw.....
936E	773	Needle Bar Screw Bushing.....
24101	—	" Clamp Body.....
808F	782	" " Screw.....
24102	1353	" " Thread Guide.....
651D	1353	" " " " Screw.....
24103	1353	Needle Clamp (high lift) complete, Nos. 651D, 808F, 24101 and 24102.....
24104	1350	Oscillating Rock Shaft.....
24105	—	Oscillating Rock Shaft complete, Nos. 4784, 12388 and 24104.....
12388	767	Oscillating Rock Shaft Hinge Pin.....
878J	783	" " " " " Oil Hole Stop Screw.....
12459	773	Oscillating Rock Shaft Hinge Pin Oil Hole Stop Screw Washer (leather).....
448c	783	Oscillating Rock Shaft Hinge Pin Set Screw.....

NO.	PLATE	NAME
4784	1353	Oscillating Rock Shaft Oil Pad.....
16509	766	" Shaft.....
19496	—	" " Crank for 19447.....
44134	—	" " " " 44135.....
19447	1353	Oscillating Shaft Crank complete, Nos. 457c, 1518E, 19449 and 19496.....
44135	5806	Oscillating Shaft Crank complete, Nos. 1518E, 19449, 44134 and two 453c.....
2049	773	Oscillating Shaft Crank Pin.....
457c	783	" " " Set Screw for 19447
453c	783	" " " " " " 44135
19448	1353	" " " Slide Block.....
229D	782	" " " " " Cap Screw.....
12424	773	Oscillating Shaft Crank Slide Block Cap Screw Washer.....
988c	1353	Oscillating Shaft Crank Slide Block Screw Stud.....
1518E	783	Oscillating Shaft Crank Slide Block Screw Stud Nut.....
19449	1353	Oscillating Shaft Crank Slide Block complete, Nos. 229D, 988c, 12424 and 19448
688J	783	Pressure Regulating Thumb Screw.....
62559	8380	Ruffling Blade.....
22356	8380	" " Holder.....
226D	1344	" " " Cap Screw.....
22357	8380	" " " Hinge Stud.....
1550r	1344	" " " " " Nut...
24204	1344	" " " Spring.....
22361	8380	" " " Stop.....
62560	8379	" Lever.....
62561	8380	" " Stud (eccentric).....
62562	8380	" " " Collar with two 465c
465c	783	" " " " Set Screw....
1701c	8380	" " " Nut.....
62563	8379	" Regulator.....
62564	8379	" " Bracket.....
171D	8380	" " " Screw (long)
971D	8380	" " " " (short)
62565	8379	" " Crank with two 453c
62566	8379	" " " Connecting Rod
61F	8380	" " " " " "
		Hinge Screw (lower).....
1520E	783	Ruffling Regulator Crank Connecting Rod Hinge Screw (lower) Nut.....
50402c	8380	Ruffling Regulator Crank Connecting Rod Hinge Screw (upper).....

NO.	PLATE	NAME
1520E	783	Ruffling Regulator Crank Connecting Rod Hinge Screw (upper) Nut.....
453c	783	Ruffling Regulator Crank Set Screw.....
50403b	8380	" " Thumb Screw.....
1749c	8380	" " " " Nut.....
62567	8380	" " " " Sleeve.....
62568	8380	" " " " Washer.....
62569	8380	" Smoothing Blade.....
665d	1344	" " " " Screw.....
2996	771	Shuttle Bobbin.....
15140	1353	" " Case Latch.....
2973	771	" " " " Lever.....
2974	771	" " " " " Fulcrum Pin.....
2975	771	Shuttle Bobbin Case Latch Spring.....
592E	782	" " " " Stop Screw.....
15141	—	Shuttle Bobbin Case Hinge, Nos. 2973, 2974 and 15140.....
7553	771	Shuttle Bobbin Case Position Finger.....
2523	771	" " " " " Rivet.....
24412	1361	" " " " " Plate.....
391d	1366	" " " " " Screw.....
24074	771	Shuttle Bobbin Case complete, Nos. 591F, 592E, 2523, 2975, 7553, 15098 and 15141.....
12393	771	Shuttle Body.....
591F	782	" Tension Regulating Screw.....
15098	771	" " Spring.....
19292	771	Shuttle, 1 1/8 in. diam., Nos. 2996, 12393 and 24074.....
*12394	—	Shuttle Driver.....
12444	771	" " 12394 with two 1266c.....
2049	773	" " Pin.....
1266c	5806	" " Set Screw.....
2531	767	" Race Back.....
2532	772	" " " Position Pin.....
2533	767	" " " Spring.....
907d	782	" " " " Screw.....
24413	—	" " Body.....
25000	—	" " " 24413 with 24414 and two 1053d.....
24414	1362	Shuttle Race Cap.....
1053d	2006	" " " Screw.....
24415	1361	Shuttle Race complete, Nos. 907d, 2531, 2533, 24412, 25000 and two each 391d and 2532.....
145d	782	Shuttle Race Screw.....
12431	—	" " Slide.....

NO.	PLATE	NAME
12432	2004	Shuttle Race Slide complete, Nos. 4307, 12431 and two 725E.....
4307	772	Shuttle Race Slide Spring.....
725E	1387	" " " " Screw.....
2102	5806	Tension Disc.....
1560c	783	" Regulating Thumb Nut.....
32572	5806	" Releasing Disc.....
43944	5806	" " Lever.....
12398	773	" " " Hinge Pin.....
12329	772	" " " Spring.....
32574	5806	" " Pin.....
50327c	5806	" Screw Stud.....
44141	—	" " " 50327c with 1560c.....
43945	5806	" Spring.....
12149	2014	" Thread Guard.....
44118	—	Tension complete, Nos. 7336, 32572, 32574, 43945, 43946, 44141 and two 2102.....
52454	5842	Thread Retainer.....
50429c	—	" " Set Screw.....
12404	770	" Take-up Crank.....
3094	773	" " " Wedge.....
690E	782	" " " " Screw.....
12408	770	" " Lever.....
775E	782	" " " Cap Screw.....
12166	773	" " " Hinge Pin.....
12409	770	" " " Link.....
11204	770	" " " " Hinge Pin.....
435c	5806	" " " " " Set Screw.....
12410	—	Thread Take-up Lever complete, Nos. 12166, 12408 and 12409.....
43946	5806	Thread Take-up Spring.....
7336	772	" " " Regulator.....
448c	783	" " " " Set Screw.....
62570	8376	Throat Plate with 62571 and two 1053d, for 62549.....
691F	782	Throat Plate Screw.....
62571	8376	" " Separating Blade.....
1053d	2006	" " " " Screw.....
24079	2644	Drip Pan with four 1 in. wire nails.....

IRON BASE

NO.	PLATE	NAME
24106	4761	Bed Frame Cushion (felt).....
158E	1206	" " " Screw.....
24107	4761	" " Hinge Connection.....

NO.	PLATE	NAME
9261	4761	Bed Frame Hinge Connection Pin.....
970D	4761	" " Thumb Screw.....
24108	3538	Bed Frame with 970D, two each 9261, 24107, four each 158E, 24106 and six wood screws 1¼ in. No. 12.....
24908	8383	Drip Pan with two wood screws ½ in. No. 5 R. H. B.....

ATTACHMENTS AND ACCESSORIES

NO.	PLATE	NAME
687E	5843	Machine Hinge Bolt with 1524E.....
1524E	5843	" " " Nut.....
6055	5843	" " " Washer.....
12361	772	" " Connection.....
44139	772	" " Plate.....
44140	—	Machine Hinge complete, Nos. 12361, 44139 and wood screw 1¼ in. No. 14.
44180	—	Machine Hinge complete, Nos. 687E, 6055, 12361 and 44139.....
12405	774	Machine Rest (felt).....
28084	—	" " Pin.....
41400	8381	" " " (wood) 3½ in. long....
36578	2045	Oiler (copper plated) with 36579.....
36579	2045	" Spout, 3½ in. long, with 120117....
120117	8381	" " Washer (leather).....
26026	2045	Screw Driver (machine).....
26485	2045	" " (shuttle tension).....
35018	2045	Tape Delivery Wire.....
8909	2045	Wrench for 1513, 1517, 1518 and 1524....
4822	2045	" " 1521 and 1528.....
8908	2045	" " 1519, 1520 and 1620.....
19221	2045	" " 936, 1516 and 1619.....
22003	2045	" " 1550 and 1749.....
20461	2045	" " 1582 and 1701.....

BELT GUARD

NO.	PLATE	NAME
41929	8383	Belt Guard.....
8418	5842	" " Button.....
8419	5842	" " " Washer (leather)....
8420	—	" " " 8418 with 8419 and wood screw 1¼ in. No. 9 R. H. B....
41930	5842	Belt Guard Hinge.....

NO.	PLATE	NAME
41931	—	Belt Guard complete, Nos. 8420, 41929, two 41930 and four wood screws ¾ in. No. 9.....

BINDERS

When ordering Binders, send sample of the binding and the material to be bound.

BINDER (Adjustable)

SIZE 1

NO.	PLATE	NAME
25644	2024	Bed with 25645.....
25645	2024	Folder.....
25646	—	" Guide (lower) with 25855.....
25855	2038	" " " Screw Stud.....
25647	2024	" " (upper).....
1577D	2024	" " " Thumb Nut.....
25648	2024	Pressure Spring.....
334D	2038	" " Screw.....
7071	2021	" " " Washer.....
25650	2024	Binder (adjustable) complete, Nos. 334D, 1577D, 7071, 25644 and 25646 to 25648
190D	782	Binder Screw.....

BINDER (Adjustable)

SIZE 2

This Binder is the same as 25650 with the following exceptions:

NO.	PLATE	NAME
25651	—	Bed with 25652, in place of 25644.....
25652	—	Folder, in place of 25645.....
25653	—	Binder (adjustable) complete, Nos. 334D, 1577D, 7071, 25646 to 25648 and 25651

BINDER (Adjustable)

SIZE 3

This Binder is the same as 25650 with the following exceptions:

NO.	PLATE	NAME
25654	—	Bed with 25655, in place of 25644.....
25655	—	Folder, in place of 25645.....
25656	—	Binder (adjustable) complete, Nos. 334D, 1577D, 7071, 25646 to 25648 and 25654

BINDER (Adjustable)**FOR SOFT HATS**

NO.	PLATE	NAME
36456	6254	Bed
36457	6254	Folder with 25669, 36458 and two 7476..
36458	6254	" " Guide Block.....
7476	2038	" " " Rivet.....
25669	—	" Slide with 25670 and 25671.....
25670	2038	" " Block.....
25671	2038	" " " Rivet.....
25672	6254	" " Carrier with 656E.....
656E	2038	" " " Adjusting Screw....
1536D	6254	" " " " " Thumb Nut
25673	6254	" " " " " " "
		Guide.....
401E	2038	Folder Slide Carrier Adjusting Thumb Nut
		Guide Screw.....
334D	2038	Folder Slide Carrier Screw.....
36459	6254	Guide (back, lower).....
36460	6254	" (back, upper).....
233D	782	" (back) Screw.....
36461	6254	" (front, lower).....
36462	6254	" (front, upper).....
233D	782	" (front) Screw.....
25677	6254	Pressure Spring.....
334D	2038	" " Screw.....
36463	6254	Binder (adjustable) complete, Nos. 401E, 1536D, 25672, 25673, 25677, 36456, 36457, 36459 to 36462, two 233D and three 334D.....
190D	782	Binder Screw.....
28713	1391	Presser Foot, for soft hat binding.....

NOTE: Presser Foot No. 28713 is used with,
but not included in, No. 36463.

BINDER (Adjustable)**FOR LEATHER BINDING, CANVAS BAGS, LEGGINGS, ETC.**

NO.	PLATE	NAME
36340	5807	Bed with two each 1036c and 1266c.....
36341	5807	Edge Guide.....
671D	5807	" " Thumb Screw.....
36342	5807	Guide (lower).....
36343	5807	" (upper).....
286D	5807	" Thumb Screw.....
1036c	5806	Leveling Screw (back).....

NO.	PLATE	NAME
1266c	5806	Leveling Screw (front).....
36344	5807	Binder (adjustable) complete, Nos. 286D, 671D and 36340 to 36343.....

BINDER (Adjustable)**FOR 44-9 AND 44-23 MACHINES**

NO.	PLATE	NAME
24344	1267	Feed Dog.....
*26951	—	Folder (lower).....
*26952	—	" (upper).....
26953	1379	Folder with Ribbon Tension complete, Nos. 26951, 26952, two each 193F, 7071 and nine 26486.....
193F	1379	Folder Screw.....
7071	1379	" " Washer.....
26954	1378	Lifting Presser Foot.....
26486	2022	Ribbon Tension Pin.....
26955	1378	Throat Plate with Extension for 24344...
19376	1378	Vibrating Presser Foot.....
26956	—	Binder (adjustable) complete, Nos. 283D, 19376, 24344 and 26953 to 26955.....
283D	1379	Binder Thumb Screw.....

BINDER (Adjustable)**FOR CAP FRONTS****FOR 44-13 MACHINE**

NO.	PLATE	NAME
26695	2024	Bed with 9558.....
25698	2024	Folder.....
9558	2038	" Steady Pin.....
26696	2024	Guide (lower) with 1141D and 9780.....
1141D	5806	" " Screw Stud.....
9780	2038	" " Stud.....
1566D	2024	" " Thumb Nut.....
26697	2024	" (upper).....
152F	2038	" " Screw.....
7071	2021	" " " Washer.....
25703	2024	Pressure Spring with 26698.....
26698	2024	" " Lifting Button.....
334D	2038	" " Screw.....
7071	2021	" " " Washer.....
26694	2024	Binder (adjustable) complete, Nos. 334D, 1566D, 25698, 25703, 26695 to 26697, two 152F and three 7071.....

NO.	PLATE	NAME
190D	782	Ribbon Tension Screw
7071	2021	" " " Washer
26249	2021	Throat Plate for 12425
26250	—	Binder complete, Nos. 190D, 207F, 12425, 25721, 25722, 25983, 26249 and two 7071

BINDER (English)

(LARGE "D" FEED)

This Binder is the same as 26250 with the following exceptions:

NO.	PLATE	NAME
12370	2023	Feed Dog, 15 teeth (16 teeth to the inch) in place of 12425
26465	2023	Throat Plate, large needle hole, for 12370, in place of 26249
35741	—	Throat Plate, small needle hole, for 12370, in place of 26249
26466	—	Binder complete, Nos. 190D, 207F, 12370, 25721, 25722, 25983, 26465 or 35741 and two 7071

BINDER (English)

This Binder is the same as 26250 with the following exceptions:

NO.	PLATE	NAME
12369	1382	Feed Dog, 12 teeth (12 teeth to the inch) in place of 12425
12457	1382	Feed Dog, 16 teeth (16 teeth to the inch) in place of 12425
28655	1382	Throat Plate, small needle hole, for 12369 or 12457, in place of 26249
28656	—	Throat Plate, large needle hole, for 12369 or 12457, in place of 26249
28657	—	Binder complete, Nos. 190D, 207F, 12369 or 12457, 25721, 25722, 25983, 28655 or 28656 and two 7071

BINDER (English)

FOR CUT CLOTH

NO.	PLATE	NAME
19474	2022	Feed Dog
25733	2022	Folder, for 1/2 in. binding
207F	2021	" Screw
7071	2021	" " Washer

NO.	PLATE	NAME
26400	2022	Presser Foot
26617	2022	Ribbon Tension Pin (bent)
26486	2022	" " " (straight)
26618	2022	" " Plate
25734	2022	Ribbon Tension complete, Nos. 26617, 26618 and seven 26486
190D	782	Ribbon Tension Screw
7071	2021	" " " Washer
26401	2022	Throat Plate for 19474
26402	—	Binder complete, Nos. 207F, 19474, 25733, 25734, 26400, 26401, two 190D and three 7071

BINDER (English)

NO.	PLATE	NAME
26603	1381	Feed Dog
120001	1381	" " (spiked teeth)
28334	1380	Folder
193F	1379	" Screw
7071	1379	" " Washer
28676	1381	Presser Foot
26617	2022	Ribbon Tension Pin (bent)
26486	2022	" " " (straight)
28336	—	" " Plate
28337	1380	Ribbon Tension complete, Nos. 26617, 28336 and eight 26486
233D	1380	Ribbon Tension Screw
28677	1381	Throat Plate for 26603 and 120001
28678	—	Binder complete, Nos. 193F, 7071, 26603 or 120001, 28334, 28337, 28676, 28677 and two 233D

BINDER (English)

(LARGE "D" FEED)

FOR CARPETS

This Binder is the same as 28678 with the following exceptions:

NO.	PLATE	NAME
12370	1382	Feed Dog, 15 teeth (16 teeth to the inch) in place of 26603
28775	1382	Throat Plate for 12370, in place of 28677
28776	—	Binder complete, Nos. 193F, 7071, 12370, 28334, 28337, 28676, 28775 and two 233D

BINDER (English)**FOR 44-9 MACHINE**

NO.	PLATE	NAME
26699	1314	Feed Dog.....
25744	1314	Folder and Ribbon Tension with nine 26486, for ½ in. binding.....
25745	—	Folder and Ribbon Tension with nine 26486, for ⅛ in. binding.....
671D	1314	Folder and Ribbon Tension Thumb Screw
26702	1314	Lifting Presser Foot.....
26486	2022	Ribbon Tension Pin (straight).....
26700	1314	Throat Plate with Extension for 26699...
26703	1314	Vibrating Presser Foot.....
26701	—	Binder complete, Nos. 671D, 25744, 25745, 26699, 26700, 26702 and 26703.....

BINDER (English)**FOR 44-9 MACHINE**

This Binder is the same as 26250 with the following exceptions:

NO.	PLATE	NAME
20106	1382	Feed Dog, in place of 12425.....
26702	1314	Lifting Presser Foot, in place of 25983... ..
28783	1382	Throat Plate for 20106, in place of 26249
26703	1314	Vibrating Presser Foot.....
28784	—	Binder complete, Nos. 190D, 207F, 20106, 25721, 25722, 26702, 26703, 28783 and two 7071.....

BINDER FOR CIRCULAR BINDING**FOR SANDALS, SLIPPERS, SHOE TONGUES, ETC.
FOR 44-9 MACHINE**

NO.	PLATE	NAME
28790	2645	Feed Dog.....
28366	2645	Folder.....
207F	2021	“ Screw.....
7071	2021	“ “ Washer.....
28791	2645	Lifting Presser Foot.....
36620	2645	Ribbon Guide.....
337D	2645	“ “ Screw.....
7806	2645	“ “ Washer.....
28792	2645	Throat Plate for 28790.....
28793	2645	Vibrating Presser Foot.....
28794	—	Binder complete, Nos. 207F, 337D, 7071, 7806, 28366, 28790 to 28793 and 36620

BINDER FOR CIRCULAR BINDING**(BIAS BINDING)****FOR SUSPENDER ENDS AND TABS, WITH MOVABLE
FOLDER FOR FINISHING OFF
FOR 44-9 MACHINE**

NO.	PLATE	NAME
28823	2646	Binder on Shank.....
207F	2021	“ Screw.....
7071	2021	“ “ Washer.....
28824	2646	Feed Dog.....
28825	2646	Lifting Presser Foot.....
28826	2646	Throat Plate for 28824.....
28827	2646	Vibrating Presser Foot.....
28828	—	Binder complete, Nos. 207F, 7071 and 28823 to 28827.....

BINDER FOR CIRCULAR BINDING**(BIAS FOLDED STRIPS)****FOR LADIES' LAWN TIES, ETC.
FOR 44-13 MACHINE**

NO.	PLATE	NAME
28790	2645	Feed Dog.....
28857	2645	Folder.....
207F	2021	“ Screw.....
7071	2021	“ “ Washer.....
28858	2645	Presser Foot with 242D, 23219 and 28859
28859	2645	“ “ Edge Guide.....
23219	2645	“ “ “ “ Position Pin... ..
242D	2645	“ “ “ “ Screw.....
28860	2645	Strip Guide.....
207F	2645	“ “ Screw.....
7071	2645	“ “ Washer.....
28792	2645	Throat Plate for 28790.....
28861	—	Binder complete, Nos. 28790, 28792, 28857, 28858, 28860 and two each 207F and 7071.....

**BINDER FOR BINDING SANDALS
AND PUMPS****FOR 44-9 MACHINE**

NO.	PLATE	NAME
36761	5660	Binder.....
228D	2038	“ Screw.....
36762	5660	Feed Dog, for narrow binding.....
120072	5660	“ “ “ wide binding.....

NO.	PLATE	NAME
36763	5660	Lifting Presser Foot.....
36764	5660	Throat Plate for 36762.....
36765	5660	Vibrating Presser Bar.....
36766	5660	" " Foot.....
36767	—	Binder complete, Nos. 36761, 36762 or 120072, 36763 to 36766 and two 228D

BINDER FOR BINDING SLIPPER AND SANDAL STRAPS

FOR 44-9 MACHINE

NO.	PLATE	NAME
36704	5659	Binder.....
228D	2038	" Screw.....
36705	5659	Feed Dog.....
36706	5659	Lifting Presser Foot.....
36707	5659	Throat Plate for 36705.....
36708	5659	Vibrating Presser Foot.....
36709	—	Binder complete, Nos. 36704 to 36708 and two 228D.....

BINDERS (Foot)

NO.	PLATE	NAME
28665	2606	Binder (foot).....
28666	2606	" " right hand.....
28667	2606	" " left hand.....
36700	5808	" " left.....
28717	1388	" " right.....
35069	2666	" " for strip, to turn the upper edge in, for skirt facings, etc.....
28769	1390	Binder (foot) to turn top only.....

BINDERS ON SHANK

NO.	PLATE	NAME
25705	—	Binder on Shank, for $\frac{3}{8}$ in. tape.....
25706	—	" " " " $\frac{1}{8}$ in. tape.....
25707	2605	" " " " $\frac{1}{2}$ in. tape.....
25708	—	" " " " $\frac{1}{16}$ in. tape.....
25709	—	" " " " $\frac{5}{8}$ in. tape.....
25710	—	" " " " $\frac{11}{16}$ in. tape.....
25711	—	" " " " $\frac{3}{4}$ in. tape.....
25712	—	" " " " $\frac{13}{16}$ in. tape.....
25713	—	" " " " $\frac{7}{8}$ in. tape.....
25714	—	" " " " $\frac{15}{16}$ in. tape.....
25715	—	" " " " 1 in. tape.....
28611	1396	" " " " suspender webs....
28612	1396	Presser Foot for 28611.....

NO.	PLATE	NAME
28631	2602	Binder on Shank.....
28632	2602	" " " to turn edges under....
28633	1399	" " " " " top edge only, for binding coats.....
28634	2602	Binder on Shank, to turn top edge only, for raw edge binding.....
28635	1398	Binder on Shank, for $\frac{7}{8}$ in. binding.....
28636	2601	" " " to turn top edge only, for bottoms of men's trousers.....
28637	2626	Binder on Shank, for bias binding, to turn top edge only, with guide for inserting canvas strip.....
28638	2600	Binder on Shank, for dress shields.....
28639	2603	" " " to turn top edge only, for suspenders.....
28640	2627	Binder on Shank, for $1\frac{1}{4}$ in. binding, for soft blankets.....
28641	2603	Binder on Shank, for $\frac{1}{8}$ in. binding.....
28643	2603	" " " with guide (wire) for mattress work.....
28693	2607	Binder on Shank, for binding the arm holes in cotton garments.....
28692	2607	Presser Foot for 28693.....
28704	2610	Binder on Shank.....
28724	2614	" " " for binding the neck of knit underwear.....
28938	2658	Presser Foot for 28724.....
28730	2615	Binder on Shank.....
28731	2616	" " " to turn under both edges of binding $\frac{1}{8}$ in.....
28732	2627	Binder on Shank, to turn under both edges of binding.....
28733	2614	Binder on Shank, for binding corset covers
28734	2615	" " " with ribbon guide, for dress shields.....
28765	2622	Binder and Folder on Shank, for folding and binding sleeves.....
28766	2622	Presser Foot for 28765.....
28910	2659	Binder on Shank.....
28804	2619	" " " for binding dress shields
35040	2658	Presser Foot for 28804.....
28751	2618	Binder and Guide on Shank, for binding upper edge of button hole strip and guiding strip and body, for shirt waists
28752	2618	Presser Foot for 28751.....
28851	2648	Binder on Shank, for 3 in. strip of bobbin- ette material, to bind $\frac{3}{4}$ in. wide.....

NO.	PLATE	NAME
28970	2659	Binder on Shank, for bias binding, to turn both edges under.....
35065	2677	Binder on Shank, for strip, to turn in upper edge only, for skirt facings, etc..
19474	1258	Feed Dog for 35208.....
19475	1258	Throat Plate for 19474.....
35208	1971	Binder on Shank, to turn in both edges of bias or straight binding, for skirts, wrappers, shirt waists, etc.....
35066	2682	Presser Foot for 35065 and 35208.....
7298	2014	" " Hinge Pin.....
120143	—	" " Plate.....
19335	—	" " Shank.....
120144	5847	Presser Foot (hinged) complete for 35065 and 35208, Nos. 7298, 19335 and 120143.....
35082	2680	Binder on Shank, for raw edge bias binding, for wrappers, etc.....
25182	2684	Binder on Shank, for cut strip, with heavy cord stitch in centre of strip, for ladies' dressing saques, etc.....
35183	2683	Presser Foot for 35182.....
26603	2033	Feed Dog for 28731.....
120001	1381	" " " ".....
35454	2616	Presser Foot for 28731.....
26605	2033	Throat Plate, large needle hole, for 26603.....
28731	2616	Binder on Shank, to turn under both edges of binding $\frac{1}{8}$ in.....
26603	2033	Feed Dog for 35226.....
120001	1381	" " " ".....
35231	2683	Presser Foot for 35226.....
26605	2033	Throat Plate, large needle hole, for 26603.....
35226	1972	Binder on Shank, for mattress work.....
19474	2067	Feed Dog for 35325.....
35066	2067	Presser Foot for 35325.....
7298	2014	" " Hinge Pin.....
120143	—	" " Plate.....
19335	—	" " Shank.....
120144	5847	Presser Foot (hinged) complete for 35325, Nos. 7298, 19335 and 120143.....
35325	2067	Binder on Shank, to turn top edge only, for shirt bosoms, skirt trimmings, etc.....
26603	2033	Feed Dog for 35354.....
120001	1381	" " " ".....
35444	—	Presser Foot Body.....
35445	—	" " Tension Plate with 35446.....
35446	2669	" " " " Guide Pin....
93F	2669	" " " " Screw.....

NO.	PLATE	NAME
2656	2669	Presser Foot Tension Plate Spring.....
35447	2669	Presser Foot (tension plate) complete for 35354, Nos. 93F, 2656, 35444 and 35445.....
26605	2033	Throat Plate, large needle hole, for 26603.....
35352	970	Binder Folder on Shank.....
35353	970	" " Hinge Plate.....
1425B	5742	" " " Screw.....
2749	5742	" " " " Friction Washer.....
35354	970	Binder on Shank (hinged) complete, for mattress work, Nos. 1425B, 2749, 35352 and 35353.....
120257	5847	Binder with tension slots on Shank, for turning in both edges of bias cut binding, for light or medium weight material..
26603	2033	Feed Dog for 35226.....
35232	2674	Lifting Presser Foot for 35226.....
26605	2033	Throat Plate, large needle hole, for 26603.....
35233	2674	Vibrating Presser Foot for 35226.....
35226	1972	Binder on Shank, for mattress work.....
35716	1253	Binder on Shank, to turn in both edges of binding, for blankets, for 44-72 Machine.....

FOR 44-9 MACHINE

19474	1258	Feed Dog, for corset work, for 35209.....
35210	2683	Lifting Presser Foot for 35209.....
19475	1258	Throat Plate, large needle hole, for 19474.....
35211	2683	Vibrating Presser Foot for 35209.....
35209	1972	Binder on Shank, to turn in both edges, for bias binding, for binding the inside of small circles, corsets, etc.....
36995	5659	Binder on Shank, for $\frac{3}{8}$ in. binding.....
36996	—	" " " " $\frac{7}{16}$ in. binding.....
36997	—	" " " " $\frac{5}{16}$ in. binding.....

BINDERS (Horn) ON SHANK

NO.	PLATE	NAME
28619	1399	Binder (horn) on Shank.....
28620	1399	Presser Foot for 28619.....
35067	2678	Binder (horn) on Shank, for strip, to turn both edges in, for ladies' collars, etc.....
35066	2682	Presser Foot for 35067.....
7298	2C14	" " Hinge Pin.....
120143	—	" " Plate.....
19335	—	" " Shank.....
120144	5847	Presser Foot (hinged) complete for 35067, Nos. 7298, 19335 and 120143.....

ORDER FOR TOP AND BOTTOM CORDING

This Corder is the same as No. 26328 with the following exceptions:

NO.	PLATE	NAME
26166	2025	Feed Dog, in place of 12372
26167	2025	Presser Foot, in place of 25984
26168	2025	Throat Plate for 26166, in place of 12442
26169	—	Corder complete, Nos. 25792, 26166 to 26168 and two 135D

ORDER FOR TOP AND BOTTOM CORDING

FOR 44-20 MACHINE

This Corder is the same as 26328 with the following exceptions:

NO.	PLATE	NAME
28748	1384	Feed Dog, in place of 12372
26167	2025	Presser Foot, in place of 25984
28749	1384	Throat Plate for 28748, in place of 12442
28750	—	Corder complete, Nos. 25792, 26167, 28748 and two 135D

ORDER FOR TOP AND BOTTOM CORDING

This Corder is the same as 26328, with the following exceptions:

NO.	PLATE	NAME
28629	1384	Feed Dog, in place of 12372
26167	2025	Presser Foot, in place of 25984
28630	1384	Throat Plate for 28629, in place of 12442
28788	—	Corder complete, Nos. 25792, 26167, 28629, 28630 and two 135D

ORDER (Bow) FOR TOP CORDING

NO.	PLATE	NAME
26937	1385	Corder Bow
4604	1385	" " Rivet
25789	1385	" " Tip
26648	1385	Presser Foot
26938	1385	Corder (bow) complete, Nos. 4604, 25789, 26648 and 26937

ORDER FOR EDGE CORDING

NO.	PLATE	NAME
35026	2673	Corder on Shank
35027	2674	Feed Dog
35028	2674	Presser Foot
35029	2674	Throat Plate for 35027
35030	—	Corder complete, for edge cording plush, Nos. 35026 to 35029

FELLER

NO.	PLATE	NAME
26403	2029	Feller (foot)

FINGER GUARD

NO.	PLATE	NAME
36818	5809	Finger Guard
36819	5809	" " Friction Washer
50316J	5809	" " Hinge Screw
36820	5809	" " Holder with 196J
196J	5809	" " " Clamping Screw
36821	5809	Finger Guard complete, Nos. 36818 to 36820 and 50316J

EDGE FOLDERS ON SHANK

NO.	PLATE	NAME
28615	1397	Edge Folder with Cord Guide on Shank, to insert and sew on insertion in one operation
28616	1397	Presser Foot (grooved) for 28615
28903	2782	Edge Folder (left hand) with right hand upper guide on shank, to turn up the body of hobbinette curtains and sew on insertion in one operation
28625	2627	Edge Folder (double) with Strip Folder and Cord Tube on Shank, for inserting cord, folding strip and stitching between the two folded edges of goods
28626	1391	Presser Foot with groove on bottom to the right of needle hole, for 28625
28646	2604	Edge Folder (double) on Shank, for men's skeleton coat seams, to turn to outside
28649	2604	Edge Folder on Shank
28702	2609	" " " " with Understrip Edge Folder, for strip when stitched to project over edge of goods

NO.	PLATE	NAME
28703	2609	Presser Foot for 28702.....
28709	2628	Edge Folder (double) on Shank, for canvas
28735	2616	“ “ on Shank, for seaming umbrellas.....
28767	2620	Edge Folder (double) on Shank, the underfold to extend $\frac{1}{8}$ in. beyond edge of upper fold.....
26948	2601	Edge Folder on Shank, to turn edge of yoke and insert body of shirt.....
28753	2618	Edge Folder and Guide on Shank, for top fold only.....
12450	2690	Feed Dog, 11 teeth (18 teeth to the inch) for 35175.....
35176	2690	Presser Foot for 35175.....
12464	2690	Throat Plate, large needle hole, for 12450
12451	—	“ “ small needle hole, for 12450
35175	2690	Edge Folder on Shank.....
35255	2693	Feed Dog for 35253.....
35254	2693	Presser Foot for 35253.....
35256	2693	Throat Plate for 35255.....
35253	2693	Edge Folder (double) on Shank, for joining yokes to the back of shirts.....
28958	2668	Edge Folder and Binder (combination) for seaming ladies' skirts and making imitation plait.....
36292	5810	Edge Folder (double) on Shank 28971 for 36293.....
28972	5810	Edge Folder Holder.....
35610	2669	“ “ “ Friction Washer.....
940F	1366	“ “ “ Hinge Screw.....
28973	5810	“ “ “ Shank.....
28971	2669	“ “ Shank.....
286D	783	“ “ Thumb Screw.....
7071	1379	“ “ “ “ Washer.....
36293	5810	Edge Folder (double) hinged, adjustable, complete, Nos. 286D, 940F, 7071, 28972, 28973, 35610 and 36292.....
12369	2699	Feed Dog, 12 teeth (12 teeth to the inch) for 36293.....
36294	5810	Presser Foot for 36293.....
12411	2699	Throat Plate, large needle hole, for 12369
120135	5846	Edge Folder (double) for turning in two edges and inserting loops in one operation.....
120136	5846	Presser Foot for 120135.....
120197	5848	Edge Folder (upper) with lower right hand guide on shank, for military uniforms..

FOR 44-22 MACHINE

NO.	PLATE	NAME
28811	2625	Edge Folder (suspended) right hand, complete, for turning edge and ruffling folded edge on skirts.....
28833	2649	Edge Folder (left hand) on Shank with right hand upper folder and separating blade.....
28862	2649	Edge Folder (double) on Shank, right hand upper, left hand lower, with separating blade, for wrappers.....
28358	2624	Edge Folder (suspended) left hand, to turn edge under.....
28359	1395	Edge Folder (double) with Separating Blade on Shank, lower folder, to turn the edge of the goods under.....
28549	1395	Edge Folder (double) with Separating Blade on Shank, lower folder, to turn the edge of the goods up.....
28756	2619	Edge Folder (left hand) on Shank with right hand lower guide.....
35922	2619	Ruffling Blade for 28756.....
28755	2621	Edge Folder (left hand) on Shank with right hand upper guide and separating blade.....
28758	2620	Edge Folder (double) with Separating Blade on Shank, lower folder, to turn the edges of the goods up.....
28760	2627	Edge Folder (right hand) on Shank with left hand lower guide.....
28763	2621	Edge Folder (left hand) on Shank with right hand lower guide.....

FOR 44-9 MACHINE

35178	2692	Feed Dog.....
35179	2692	Lifting Presser Foot.....
35180	2692	Throat Plate for 35178.....
35181	2692	Vibrating Presser Foot.....
35177	2691	Edge Folder (double) on Shank, for oil cloth and leather.....

STRIP FOLDERS

NO.	PLATE	NAME
28613	1396	Strip Folder on Shank, for overall shoulder straps.....
28614	1396	Presser Foot for 28613.....

NO.	PLATE	NAME
28617	1398	Strip Folder on Shank, for inserting folded strip, for trimming mantles
28618	1398	Presser Foot (grooved) for strip, for 28617
28647	2626	Strip Folder on Shank
28648	2626	" " " " for making straps
28698	2608	" " " " with cord tube.
28699	2608	Presser Foot, grooved to the right of needle hole, for 28698
28708	2611	Strip Folder on Shank, for folding strip and stitching down centre.
28764	2622	Strip Folder on Shank with left hand upper guide
28848	2648	Strip Folder on Shank, for folding overall straps
28849	1387	Presser Foot with guide on bottom to the left of needle hole, for 28848.
19474	2067	Feed Dog for 35345
35346	2669	Presser Foot for 35345
24572	2067	Throat Plate, small needle hole, for 19474
35345	953	Strip Folder on Shank, for making straps
35347	970	" " (double) hinged, for turning in the right hand edges of strips, for making strip, for 35348
35348	970	Strip Folder, for turning in the upper and lower edges of strip made on 35347.
35349	970	Strip Folder Holder and Guide
190 ^D	782	" " " " " Screw
7071	2021	" " " " " Washer
19474	946	Feed Dog for 35351
35350	946	Presser Foot for 35351
24572	2067	Throat Plate, small needle hole, for 19474
35351	—	Attachment complete, for making two-piece apron straps, cloth suspenders, etc., Nos. 19474, 24572, 35347 to 35350 and two each 190 ^D and 7071.
35855	1253	Strip Folder on Shank, for collar bands.
26603	2033	Feed Dog for 35855
35856	2669	Presser Foot for 35855
26605	2033	Throat Plate, large needle hole, for 26603
28728	2628	Strip Folder on Shank, to turn in the raw edge on lower fold
120191	5845	Strip Folder on Shank, to turn in both edges
28754	2628	Strip Folder on Shank, for suspender straps, to turn both edges
28945	2666	Strip Folder on Shank, for making overall straps

FOR 44-9 MACHINE

NO.	PLATE	NAME
19474	2067	Feed Dog
35322	2697	Lifting Presser Foot
24572	2067	Throat Plate, small needle hole, for 19474
35323	2697	Vibrating Presser Foot
35324	2684	Strip Folder on Shank, for making four-ply bands, for ladies' stock collars, etc.

STRIP FOLDER (Foot)

NO.	PLATE	NAME
28705	2627	Strip Folder with Arm
28706	2627	" " Hinge Bracket with 448c and 2273
448c	783	Strip Folder Hinge Bracket Set Screw.
96 ^D	1394	" " " Screw
26173	1394	" " Lock Stud
26174	1394	" " " " Spring
228 ^D	1394	" " " " " Screw
2273	1394	" " Stop Pin
28707	2627	Strip Folder (foot, hinged) complete, for folding and stitching plait on shirt bosom, Nos. 96 ^D , 228 ^D , 26173, 26174, 28705 and 28706.

STRIP FOLDER ON SHANK

FOR 44-75 MACHINE

NO.	PLATE	NAME
120015	5688	Guide Wire with 120018
120016	8376	" " Clamp
703 ^B	8376	" " " Thumb Screw
120017	5688	" " Extension
120018	5688	" " " Clamp with 207 ^B and 793 ^B
793 ^B	8376	Guide Wire Extension Clamp Thumb Screw
207 ^B	1375	Guide Wire Extension Set Screw
703 ^B	8376	" " Thumb Screw
3146	1353	" " " " Washer
120019	5688	Strip Folder on Shank with 3146, 120015 to 120017 and two 703 ^B
1423 ^B	5742	Strip Folder Screw

GUIDES

NO.	PLATE	NAME
25866	2045	Guide, for flush throat plate.....
25874	2045	" " raised throat plate.....
35190	2697	" " 28967.....
25873	2045	" (combination).....
28658	1377	" (roller) with 1852.....
1852	1377	" Roller.....
284D	1366	" Thumb Screw for 25874.....
732D	1366	" " for 25866.....
3146	1353	" " " Washer for 25873..
28674	2607	Lap Seam Guide on Shank.....

GUIDE (Adjustable, Hinged)

NO.	PLATE	NAME
28971	2669	Guide.....
28972	2669	" Holder.....
35610	2669	" " Friction Washer.....
940D	5742	" " Hinge Screw.....
28973	2669	" " Shank.....
286D	783	" Thumb Screw.....
7071	2021	" " " Washer.....
28969	2669	Guide (adjustable, hinged) complete, Nos. 286D, 940D, 7071, 28971 to 28973 and 35610.....

GUIDE WITH DISENGAGING LEVER

FOR MACHINE-TURNED WORK FOR 44-29 MACHINE

NO.	PLATE	NAME
36115	5696	Guide on Slide with 36113.....
35838	5696	" Bed.....
36116	5696	" Disengaging Lever with 2113, 19045 and 35840.....
19045	—	Guide Disengaging Lever Handle.....
35840	—	" " " " Washer.....
990F	5696	" " " Screw.....
35841	5696	" " " Spring.....
2113	1388	" " " Guide Pin.....
36113	5696	" Tip.....
36117	5696	Guide with Disengaging Lever complete, Nos. 990F, 35838, 35841, 36115 and 36116.....
35580	—	Feed Dog (sharp teeth).....
35581	—	Presser Foot.....

NO.	PLATE	NAME
35582	—	Throat Plate for 35580.....
35583	—	" " Guide.....
337D	1383	" " " Screw.....

EDGE GUIDE

FOR 44-22 MACHINE

NO.	PLATE	NAME
28838	2650	Edge Guide (suspended) left hand.....

EDGE GUIDE (Roller)

NO.	PLATE	NAME
26803	1375	Edge Guide Bed with 2362.....
220D	1375	" " Leveling Screw.....
36760	1375	" " Slide with 26809, 51809 and two 12152.....
26805	1375	Edge Guide Slide Cap (left).....
207F	1375	" " " " " Screw.....
2362	1375	" " " " " Steady Pin..
26806	1375	" " " " (right).....
207F	1375	" " " " " Screw (large)
233D	1375	" " " " " " (small)
26807	1375	" " " Lever.....
94D	1375	" " " " Hinge Screw....
51809	1375	" " " Roller and Stud.....
26808	1375	" " " Spring.....
26809	1375	" " " " Cover.....
12152	1375	" " " " " Rivet....
26810	1375	Edge Guide (roller) complete, Nos. 94D, 233D, 26803, 26805 to 26808, 36760, two 207F and four 220D.....
190D	1375	Edge Guide Screw.....

EDGE GUIDE (Roller)

FOR GLOVE WORK

NO.	PLATE	NAME
36185	6252	Edge Guide Arm with 1988.....
36186	6252	" " " Friction Washer.....
1425D	6252	" " " Hinge Screw.....
1988	6252	" " " Roller and Screw Stud
36187	6252	" " Bed with four 465F.....
465F	6252	" " " Leveling Screw.....
36188	6252	Edge Guide (roller) complete, Nos. 1425D and 36185 to 36187.....

STRIP GUIDE

NO.	PLATE	NAME
28712	2612	Strip Guide on Shank.....

HEMMERS

HEMMER WITH LEVER, FOR OPENING THE FOLDER AND RELEASING THE HEM, SO THAT IT CAN BE FINISHED WITHOUT REMOVING THE HEMMER FROM MACHINE. FOR SKIRTS, OVERALLS OR SIMILAR CLOSED ARTICLES.

NO.	PLATE	NAME
28679	1376	Hemmer Bed with 28681.....
28680	1376	" Folder (left).....
233D	1376	" " " Screw.....
2362	1376	" " " Steady Pin.....
28681	1376	" " (right).....
28685	1376	" " Disengaging Lever.....
94D	1376	" " " " Hinge Screw.....
2362	1376	Hemmer Folder Disengaging Lever Stop Pin.....
28682	1376	Hemmer Slide with 28687 and two each 2362 and 12152.....
28683	1376	Hemmer Slide Cap (left).....
28684	1376	" " " (right).....
207F	1376	" " " Screw (back).....
233D	1376	" " " " (front).....
28686	1376	" " Spring.....
28687	1376	" " " Cover.....
12152	1376	" " " " Rivet.....
28688	1376	Hemmer complete, Nos. 94D, 28679, 28680, 28682 to 28686, two 207F and three 233D.....
190D	1376	Hemmer Screw.....
18055	1394	Presser Foot Hinge Pin.....
28689	—	" " Plate.....
28690	—	" " Shank.....
26231	1353	" " Spring.....
28691	1391	Presser Foot (spring hinged) complete, Nos. 18055, 26231, 28689 and 28690...

HEMMERS (Foot)

NO.	PLATE	NAME
28663	2028	Hemmer (foot) $\frac{1}{8}$ in. hem, for 12372, 12455, 20002, 20117 and 20151.....
25919	—	Hemmer (foot) $\frac{3}{4}$ in. hem, for 12372, 12455, 20002, 20117 and 20151.....

NO.	PLATE	NAME
25920	2028	Hemmer (foot) $\frac{1}{8}$ in. hem, for 12372, 12455, 20002, 20117 and 20151.....
25921	—	Hemmer (foot) long, $\frac{1}{8}$ in. hem, for shirts, for 12372, 12455, 20002, 20117 and 20151.....
25922	2028	Hemmer (foot) $\frac{3}{16}$ in. hem, for 12369 and 12457.....
25923	—	Hemmer (foot) long, $\frac{3}{16}$ in. hem, for shirts, for 12369 and 12457.....
25924	—	Hemmer (foot) $\frac{1}{4}$ in. hem, for 12369 and 12457.....
26428	2028	Hemmer (foot) $\frac{1}{8}$ in. hem, for 12437 and 20147.....
36085	—	Hemmer (foot) $\frac{1}{16}$ in. hem, slotted for lace
28664	—	" " $\frac{3}{32}$ in. hem, slotted for lace
28662	2028	" " $\frac{1}{8}$ in. hem, slotted for lace
28661	2028	" " $\frac{3}{16}$ in. hem, for gusset work
28741	2028	" " $\frac{1}{8}$ in. hem, for bagging...
28669	2606	" Spring for 28670.....
26459	5806	" " Rivet.....
28670	2606	" (foot) $\frac{1}{4}$ in. hem, with 28669 and two 26459.....
28742	1388	Hemmer (foot) to make stitch in centre of hem.....
26607	1387	Presser Foot Body for 26610, 26611 and 35016.....
35016	—	Hemmer, $\frac{1}{16}$ in. hem, for 26607.....
26610	1387	" $\frac{1}{8}$ in. hem, for 26607.....
26611	—	" $\frac{3}{16}$ in. hem, for 26607.....
35710	1252	" (foot) $\frac{3}{32}$ in. hem, with guide on bottom to the right of needle hole.....
35682	—	Hemmer (foot) $\frac{1}{8}$ in. hem, with guide on bottom to the right of needle hole.....
36524	—	Hemmer (foot) $\frac{5}{32}$ in. hem, with guide on bottom to the right of needle hole.....
35997	—	Hemmer (foot) $\frac{3}{16}$ in. hem, with guide on bottom to the right of needle hole.....
36309	—	Hemmer (foot) $\frac{7}{32}$ in. hem, with guide on bottom to the right of needle hole.....
36072	—	Hemmer (foot) $\frac{1}{4}$ in. hem, with guide on bottom to the right of needle hole.....
35711	1252	Feed Dog for 35712.....
35712	1252	Throat Plate, small needle hole, for 35711, for 35682, 35710, 35997 and 36072.....

NOTE: When ordering No. 35712, state width
of hem for which it is required.

NO.	PLATE	NAME
Nos. 36980 TO 36983 FOR 12437 AND 20147		
36980	—	Hemmer (foot) $\frac{3}{8}$ in. hem.....
36981	—	" " " $\frac{5}{8}$ in. hem.....
36982	—	" " " $\frac{1}{8}$ in. hem.....
36983	—	" " " $\frac{1}{4}$ in. hem.....

HEMMER (Foot) ADJUSTABLE FOR TENNIS SHOES

NO.	PLATE	NAME
120073	—	Hemmer Block with 39395.....
50441D	5839	" " Hinge Screw.....
39395	5839	" " Pin.....
120074	—	" " Spring.....
651D	1353	" " " Screw.....
120075	—	" Guide.....
50169D	5839	" " Screw.....
120076	—	" Plate.....
219D	774	" " Screw.....
120077	—	" Shank.....
120078	5839	Hemmer (foot) adjustable, complete, Nos. 219D, 651D, 50169D, 50441D and 120073 to 120077.....

HEMMERS (Foot) PLAIN BOTTOM

NO.	PLATE	NAME
28795	—	Hemmer (foot) plain bottom, $\frac{1}{8}$ in. hem..
26160	—	" " " " $\frac{3}{8}$ in. hem..
26161	2028	" " " " $\frac{1}{8}$ in. hem..
26162	—	" " " " $\frac{1}{4}$ in. hem..
26163	—	" " " " $\frac{1}{4}$ in. hem..
6267	2028	" Folder.....
25888	2028	" Tongue.....

NOTE: When ordering Nos. 6267 or 25888, state width of hem and No. of Hemmer for which it is required.

HEMMERS ON SHANK

NO.	PLATE	NAME
12450	777	Feed Dog, 11 teeth (18 teeth to the inch)
26656	2030	Presser Foot for 26655.....
12464	777	Throat Plate, large needle hole, for 12450
12451	—	" " small needle hole, for 12450
26652	—	Hemmer, $\frac{3}{8}$ in. hem.....
26654	2032	" Rivet.....
26653	2032	" Shank.....

NO.	PLATE	NAME
26655	2031	Hemmer on Shank complete, Nos. 26652 to 26654.....
26659	—	Hemmer for 26660.....
26660	2031	Hemmer on Shank complete, $\frac{3}{8}$ in. hem, for umbrella work, Nos. 26653, 26654 and 26659.....
26661	—	Hemmer (wide) for 26662.....
26662	2031	Hemmer on Shank complete, Nos. 26653, 26654 and 26661.....
26663	—	Hemmer for 26664.....
26664	2030	Hemmer on Shank complete, for raw edge silk, Nos. 26653, 26654 and 26663.....
26665	—	Hemmer, $\frac{1}{8}$ in. hem, for 26666.....
26666	2030	Hemmer on Shank complete, Nos. 26653, 26654 and 26665.....
26934	—	Hemmer (narrow) for 26935.....
26935	1386	Hemmer on Shank complete, Nos. 26653, 26654 and 26934.....
28947	—	Hemmer for 28948.....
28948	1386	Hemmer on Shank complete, for one fold, with right hand lower guide, for lace, Nos. 26653, 26654 and 28947.....
36520	—	Hemmer, $\frac{1}{4}$ in. hem.....
36521	5811	Hemmer on Shank complete, Nos. 26653, 26654 and 36520.....
36711	—	Hemmer, $\frac{1}{4}$ in. hem.....
36712	5811	Hemmer on Shank complete, for umbrella work, Nos. 26653, 26654 and 36711.....
28623	2602	Hemmer and Corder on Shank, to take goods from above to cord bottom.....
28624	2602	Presser Foot with groove on bottom to the right of needle hole, for 28623.....
28627	2600	Hemmer on Shank, for $\frac{3}{8}$ in. hem, for Marseilles quilts.....
28628	2600	Presser Foot for 28627.....
28650	2604	Hemmer on Shank, for hemming heavy Canton flannel.....
28651	2605	Hemmer on Shank, for turning tops and bottoms of canvas leggings.....
28652	2605	Hemmer on Shank, $1\frac{2}{16}$ in. to 2 in. hem..
28653	—	" " " $2\frac{2}{16}$ in. to 3 in. hem..
28700	2609	Hemmer (short head) on Shank, for hem- ming stable blankets.....
28701	1391	Presser Foot (tube) for laying braid on stable blankets, for 28700.....
36589	—	Presser Foot for 28700.....

HEMMERS

NO.	PLATE	NAME
28710	2612	Hemmer on Shank, $\frac{1}{8}$ in. hem.....
28711	2607	" " " $\frac{3}{8}$ in. hem, for hem- ming towels.....
28719	2613	Hemmer on Shank, $\frac{1}{4}$ in. to $\frac{1}{2}$ in. hem..
120287	2613	Hemmer.....
120288	2613	" Shank.....
28720	2613	Hemmer on Shank, $\frac{3}{4}$ in. to 1 in. hem, complete, Nos. 120287 and 120288.....
28721	—	Hemmer on Shank, $1\frac{1}{4}$ to 2 in. hem.....
36776	—	" " " $2\frac{1}{4}$ in. to 3 in. hem..
28722	2613	" " " for heavy woven goods
28723	2614	" " " with guide for hemming and stitching on lace in one operation..
28736	2617	Hemmer on Shank, for umbrella work...
28737	2615	" " " for soft material, to turn the hem under.....
28738	2617	Hemmer on Shank, $\frac{3}{8}$ in. hem, to turn the hem under.....
28739	2626	Hemmer on Shank, 3 in. hem, for sheets and pillow slips, to turn the hem under
28935	2661	Hemmer on Shank, for bobbinette mate- rial, to turn the hem under.....
35022	1386	Hemmer on Shank, $\frac{1}{8}$ in. hem, with right hand lower guide, for lace.....
35475	976	Hemmer on Shank, $\frac{5}{32}$ in. hem, with right hand lower guide, for lace.....
35023	2672	Hemmer on Shank, $\frac{1}{8}$ in. hem, with left hand lower guide, for lace.....
35064	2661	Hemmer on Shank, 1 in. to 2 in. hem, for general work.....
35104	2684	Hemmer on Shank, for bottom of shirt waists, for inserting drawing or shirring string.....
35063	2676	Presser Foot for 35104.....
35832	2669	" " " heavy work, for 35104..
35166	2694	Hemmer on Shank, 1 in. hem, to turn the goods under.....
120289	—	Hemmer on Shank, 2 in. hem, to turn the goods under.....
28614	1396	Presser Foot for 35166.....
19474	2695	Feed Dog for 35236.....
35063	2676	Presser Foot for 35236.....
19475	2695	Throat Plate, large needle hole, for 19474
35236	1971	Hemmer on Shank, for bottom of shirt waists.....
19474	2695	Feed Dog for 35241.....

HEMMERS

NO.	PLATE	NAME
35066	2695	Presser Foot for 35241.....
7298	2014	" " Hinge Pin.....
120143	—	" " Plate.....
19335	—	" " Shank.....
120144	5847	Presser Foot (hinged) complete for 35241, Nos. 7298, 19335 and 120143.....
19475	2695	Throat Plate, large needle hole, for 19474
35241	2695	Hemmer on Shank, for Canton flannel, etc.
26603	5644	Feed Dog for 35863.....
35066	5644	Presser Foot for 35863.....
26605	5644	Throat Plate, large needle hole, for 26603
35863	5644	Hemmer on Shank, for canvas work.....
35679	932	" Folder on Shank for 35681.....
35353	932	" " Hinge Plate for 35681...
1425B	932	" " " Screw.....
36006	932	" " " Washer....
35681	932	Hemmer on Shank (hinged) complete, for mattress work, Nos. 1425B, 35353, 35679 and 36006.....
26603	932	Feed Dog for 35681.....
35066	932	Presser Foot for 35681.....
26605	932	Throat Plate, large needle hole, for 26603
28777	2623	Hemmer (double) on Shank, for headings
28778	2623	Presser Foot for 28777.....
28779	2623	Ruffling Blade for 28777.....
35700	1250	Hemmer (left hand) with right hand lower guide on Shank, for 44-22 Machine....

HEMSTITCHER

NO.	PLATE	NAME
28671	1392	Hemstitcher.....

LAP SEAM FELLER

NO.	PLATE	NAME
28673	2607	Lap Seam Feller (right hand) on Shank, to fold top only.....
28674	2607	Lap Seam Guide on Shank.....

PRESSER FOOT

NO.	PLATE	NAME
25985	2029	Presser Foot (single toe) for gathering...
26638	2029	" " (double toe) for gathering...
26639	—	" " with 228D, for 26641.....
26640	2029	" " Adjustable Guide for 26641

NO.	PLATE	NAME
228D	2038	Presser Foot Adjustable Guide Screw...
26641	2029	" " 26639 with Adjustable Guide, No. 26640, for tailor work.....
26642	—	Presser Foot.....
26643	2029	" " Guide.....
26644	1394	" " " Hinge Pin.....
26645	1394	" " " Spring.....
337D	1388	" " " " Screw.....
26646	2029	Presser Foot (spring guide) complete, Nos. 337D and 26642 to 26645.....
26650	2029	Presser Foot, for braiding.....
26651	2032	" " " folding umbrella straps.....
26801	1387	" " Adjustable Guide for 26802.....
725D	1387	" " " " Screw.....
26802	1387	Presser Foot with two adjustable guides No. 26801 and two 725D.....
26936	1387	Presser Foot, for etching.....
26978	1391	" " Graduated Adjustable Guide for 26977.....
335D	1317	Presser Foot Graduated Adjustable Guide Screw.....
26977	1391	Presser Foot with Graduated Adjustable Guide No. 26978 and 335D, for tailor work.....
28668	2606	Presser Foot (strip folding).....
28672	1391	" " two grooves to the right of needle hole, for cording.....
28675	1391	Presser Foot (pointed toe) for stitching box plaiting on body of material.....
28714	2611	Presser Foot (strip folding) for shirt-waist work.....
28715	1391	Presser Foot (tube) for laying fringe-edged braid.....
28716	2610	Presser Foot (strip folding) for raw edge strip, to turn edges under, for $\frac{3}{8}$ in. to 1 in. strip.....
35877	—	Presser Foot (strip folding) for raw edge strip, to turn edges under, for $1\frac{1}{8}$ in. to 2 in. strip.....
28725	1388	Presser Foot Spring Guide for 28726.....
665D	1388	" " " " Screw.....
28726	1388	Presser Foot (right hand, spring guide) with 665D and 28725, for $\frac{1}{2}$ in. to $\frac{1}{4}$ in. gauge.....

NOTE: When ordering Nos. 28725 or 28726, state
required distance from edge of goods to seam.

NO.	PLATE	NAME
28743	1388	Presser Foot (grooved) with tube, for cording.....
28744	1389	Presser Foot (strip folding) grooved, with two cord tubes, for making double cord- ed strip.....
28745	1389	Presser Foot (strip folding) to fold both edges of strip.....
28746	1388	Presser Foot (tube) for guiding and stitch- ing the left hand edge of ribbon.....
28747	1389	Presser Foot, for bias binding, the velve- teen to project $\frac{3}{8}$ in.....
28768	1390	Presser Foot (strip folding) for folding a $2\frac{1}{2}$ in. strip to a 1 in. strip, to be stitched on shirt bosoms, for imitation tuck.....
28830	1387	Presser Foot (grooved) for cording, for carriage work.....
28908	2658	Presser Foot Spring Guide for 28909.....
665D	1388	" " " " Screw.....
28909	2658	" " (left hand, spring guide) with 665D and 28908.....
28920	1387	Presser Foot, for braiding, to stitch braid on right hand edge.....
28944	2665	Presser Foot (strip folding) for making raw edge straps of bias chiffon.....
35189	2697	Feed Dog for 28967.....
35190	2697	Guide for 28967.....
28964	—	Presser Foot Body.....
28965	2658	" " Knife.....
28966	2658	" " " Clamp.....
198D	2658	" " " " Screw.....
15072	2658	" " " " Steady Pin...
28967	2658	Presser Foot complete, for grooving insoles, Nos. 198D, 15072 and 28964 to 28966...
35191	2697	Throat Plate, for under braiding, for 35189
2532	772	Presser Foot Hinge Pin.....
24488	—	" " Plate.....
19223	—	" " Shank.....
24489	1309	Presser Foot (hinged) complete, for heavy work, Nos. 2532, 19223 and 24488.....
28770	—	Presser Foot.....
28771	1388	" " Guide.....
15072	1388	" " " Hinge Pin.....
28772	1388	" " " Spring.....
337D	1388	" " " " Screw.....
2113	1388	" " " " Steady Pin...
28773	1388	Presser Foot (spring guide) for gores, Nos. 337D, 2113, 15072 and 28770 to 28772

NO.	PLATE	NAME
35129	2682	Presser Foot (strip folding) for covering cord with folded strip.....
35184	2682	Presser Foot, for darning.....
35172	2682	" " (tube) for guiding and stitching the right hand edge of ribbon.....
35242	2698	Feed Dog for 35243.....
35243	2698	Presser Foot (strip folding) with tube for inserting cord, for making loops for dressing gowns.....
35244	2698	Throat Plate for 35242.....
35690	1246	Presser Foot (strip folding) for making straps from 1 in. to 1½ in. wide.....
44158	5842	Feed Dog.....
26276	1394	Presser Foot Hinge Pin.....
44159	—	" " Plate.....
44160	—	" " Shank.....
44161	5842	Presser Foot (hinged) complete, Nos. 26276, 44159 and 44160.....
44162	5842	Throat Plate for 44158.....
35995	5645	Presser Foot with right hand folder, for folding and stitching facing to shoe lining.....
36022	5645	Presser Foot with 665D and 36023, for blind stitch cording, for 12 to 44 ligne cord, for ornamental cording on skirts, suits, etc.....
36023	5645	Presser Foot Cord Guide for 36022.....
NOTE: When ordering Nos. 36022 or 36023, state the size or send sample of cord for which it is to be used.		
665D	5645	Presser Foot Cord Guide Screw.....
36182	5808	" " with 665D and 36183, for blind stitch braiding, for soutache braid.....
36183	5808	Presser Foot Braid Guide.....
NOTE: When ordering Nos. 36182 or 36183, send sample of braid for which it is to be used.		
665D	1388	Presser Foot Braid Guide Screw.....
36622	5808	" " for 36623.....
36623	5808	" " 36622 with 36576 and two 50202D.....
36576	5808	Presser Foot Finger Guard.....
50202D	5808	" " " " Screw.....

PRESSER FEET (Glass Plate)

NO.	PLATE	NAME
26607	1387	Presser Foot Body.....
26608	1387	" " Plate (glass).....
26609	—	Presser Foot (glass plate) complete, Nos. 26607 and 26608.....

PRESSER FEET WITH GRADUATED ADJUSTABLE GUIDES

NO.	PLATE	NAME
28949	—	Presser Foot.....
28950	2658	" " Graduated Adjustable Guide.....
28951	2671	" " " " " " Clamping Lever.....
2653	2671	Presser Foot Graduated Adjustable Guide Clamping Lever Hinge Pin.....
28952	2671	Presser Foot Graduated Adjustable Guide Clamping Lever Spring.....
26092	2671	Presser Foot Graduated Adjustable Guide Clamping Lever Spring Rivet.....
28953	2658	Presser Foot Graduated Adjustable Guide complete, for tailor work, Nos. 2653, 26092 and 28949 to 28952.....
35134	2671	Presser Foot.....
35002	2671	" " Extension.....
35003	2671	" " Graduated Adjustable Guide (long, left).....
35004	2671	Presser Foot Graduated Adjustable Guide (long, right).....
35005	2671	Presser Foot Graduated Adjustable Guide (short, right).....
35006	2671	Presser Foot Graduated Adjustable Guide (short, right) flush.....
35135	2671	Presser Foot Graduated Adjustable Guide Clamp.....
35136	2671	Presser Foot Graduated Adjustable Guide Clamp Lever.....
337B	2671	Presser Foot Graduated Adjustable Guide Clamp Screw.....
36696	2671	Presser Foot Graduated Adjustable Guide Clamp Steady Pin.....
35137	—	Presser Foot with Extension and Graduated Adjustable Guide complete, Nos. 337B, 35002 to 35006, 35134 to 35136 and 36696.....

FOR 44-22 MACHINE

NO.	PLATE	NAME
28761	1390	Presser Foot with 219F and 28762, for stitching ribbon and net material.....
28762	1390	Presser Foot Ribbon Guide.....
219F	774	" " " " Screw.....

PRESSER FOOT EXTENSIONS

NO.	PLATE	NAME
12435	780	Presser Foot with 228D.....
2532	1371	" " Hinge Pin.....
20155	—	" " Plate.....
20156	—	" " Shank.....
20157	780	Presser Foot (hinged) complete, Nos. 228D, 2532, 20155 and 20156.....
26279	—	Presser Foot Extension, $\frac{1}{8}$ in., for 12435 and 20157.....
26280	—	Presser Foot Extension, $\frac{1}{8}$ in., for 12435 and 20157.....
26281	1387	Presser Foot Extension, $\frac{1}{4}$ in., for 12435 and 20157.....
26282	—	Presser Foot Extension, $\frac{3}{8}$ in., for 12435 and 20157.....
26283	—	Presser Foot Extension, $\frac{1}{2}$ in., for 12435 and 20157.....
228D	2038	Presser Foot Extension Screw for 12435 and 20157.....
44158	5842	Feed Dog.....
26276	1394	Presser Foot Hinge Pin.....
44159	—	" " Plate.....
44160	—	" " Shank.....
44161	5842	Presser Foot (hinged) complete, Nos. 26276, 44159 and 44160.....
44162	5842	Throat Plate for 44158.....

PRESSER FOOT STRIP GAUGE

NO.	PLATE	NAME
12435	780	Presser Foot with 228D.....
2532	1371	" " Hinge Pin.....
20155	—	" " Plate.....
20156	—	" " Shank.....
20157	780	Presser Foot (hinged) complete, Nos. 228D, 2532, 20155 and 20156.....
25967	1387	Presser Foot Strip Gauge for 12435 and 20157.....
228D	2038	Presser Foot Strip Gauge Screw.....

PIPING ATTACHMENTS

NO.	PLATE	NAME
28621	1397	Piping Attachment and Strip Folder on Shank, for car-seat cushions.....
28622	1397	Presser Foot (grooved) for 28621.....
28740	2617	Piping Attachment on Shank.....
28803	2619	" " " " for flannel without cord.....
28974	2661	Piping Attachment on Shank.....
28975	2658	Presser Foot, 16 teeth, for 28974.....
12457	2699	Feed Dog, 16 teeth (16 teeth to the inch) for 35245.....
35246	2699	Presser Foot for 35245.....
12411	2699	Throat Plate for 12457.....
35245	2699	Piping Attachment on Shank.....
36129	5812	" " (double, adjustable) on Shank with upper edge folder.....
36131	5812	Presser Foot for 36129.....

QUILTERS

NO.	PLATE	NAME
25991	2029	Quilter Guide for 25990.....
25992	2029	" " Holder with two 207F.....
207F	2021	" " " Set Screw.....
207F	2021	" " " Set Screw.....
25990	2029	Quilter complete, Nos. 25991 and 25992.....
28659	1392	" Guide for 28660.....
25992	1392	" " Holder with two 207F.....
207F	2021	" " " Set Screw.....
207F	2021	" " " Set Screw.....
28660	1392	Quilter complete, Nos. 25992 and 28659.....

RUFFLERS

RUFFLER (Power)

NO.	PLATE	NAME
26005	984	Driving Lever.....
69D	5742	" " Hinge Screw.....
35019	984	" " Spring.....
1666D	984	" " " Adjusting Nut.....
26007	984	Foot.....
207F	2021	" Screw.....
26016	984	Frame.....
26017	984	Needle Clamp with 808F.....
808F	782	" " Screw.....

NO.	PLATE	NAME
26010	984	Ruffling Blade with 8505.....
	811D 5742	" " Hinge Screw.....
26011	984	" " Lever with 26189 and 26629
	812B 984	" " " Adjusting Thumb Screw
	1621E 984	" " " " " " " "
		Nut.....
26629	2014	Ruffling Blade Lever Protector.....
26189	2014	" " " " Rivet....
	8505 773	" " Rivet.....
26018	984	Ruffler complete, Nos. 69D, 207F, 811D, 812B, 1621E, 1666D, 26005, 26007, 26010, 26011, 26016, 26017 and 35019.....
24303	1344	Feed Dog.....
24306	1344	Throat Plate for 24303.....

RUFFLER (Power)

NO.	PLATE	NAME
25997	984	Driving Lever.....
	69D 5742	" " Hinge Screw.....
25998	984	" " Spring.....
	1582D 984	" " " Adjusting Nut....
25993	984	Frame with 25994 to 25996 and 26001...
25995	2014	" Block.....
25996	2014	" " Rivet.....
25994	2014	" Stud.....
	207F 2021	" " Set Screw.....
26718	1370	Needle Clamp Body.....
	1943 1370	" " Roller.....
	1115F 1370	" " Screw.....
26719	984	Needle Clamp complete, Nos. 1115F, 1943 and 26718.....
25999	984	Ruffling Blade.....
26002	2014	" " Clamp.....
	337D 1388	" " " Screw.....
26000	984	" " Lever.....
	560B 984	" " " Adjusting Thumb Screw
	1603E 984	" " " " " " " "
		Nut.....
26001	2014	Ruffling Blade Lever Stop Pin.....
26229	984	" Presser Foot.....
26230	984	Ruffler complete, Nos. 69D, 207F, 560B, 1582D, 1603E, 25993, 25997 to 26000, 26002, 26229, 26719 and two 337D.....

RUFFLER (Power)

WITH RIGHT AND LEFT GUIDES, SEPARATING BLADES
AND DISENGAGING LEVER TO THROW RUFFLING
BLADE OUT OF ACTION

NO.	PLATE	NAME
26722	2035	Driving Lever.....
	1101c 2035	" " Hinge Screw.....
26668	2035	" " Spring.....
	1640c 2035	" " " Adjusting Nut....
26669	2035	Frame.....
26670	2034	Guide (left) with 26679 and two 662D....
26671	2035	" (right) with 26679 and two 662D....
	223D 2035	" Screw.....
26718	1370	Needle Clamp Body.....
	1943 2034	" " Roller.....
	1115F 2034	" " Screw.....
26719	2034	Needle Clamp complete, Nos. 1115F, 1943 and 26718.....
26675	2035	Ruffling Blade.....
26676	2035	" " Clamp.....
	337D 2035	" " " Screw.....
26723	2034	" " Lever.....
	812B 2035	" " " Adjusting Thumb Screw
	1621E 2035	" " " " " " " "
		Nut.....
26678	2035	Ruffling Blade Lever Disengaging Lever
	102D 2035	" " " " " " " "
		Hinge Screw.....
2301	2035	Ruffling Blade Lever Disengaging Lever Stop Pin.....
26679	2035	Separating Blade.....
	662D 2035	" " Screw.....
26724	2034	Ruffler complete, Nos. 102D, 223D, 812B, 1101c, 1621E, 1640c, 2301, 26668 to 26671, 26675, 26676, 26678, 26719, 26722, 26723 and two 337D.....

RUFFLER (Power)

WITH LEVER FOR THROWING RUFFLING BLADE INTO
ACTION FOR INTERMITTENT RUFFLING, SUCH
AS YOKING SKIRTS, ETC.

NO.	PLATE	NAME
28590	1371	Driving Lever.....
	1101c 1371	" " Hinge Screw.....
	1647c 1371	" " " " Nut.....

NO.	PLATE	NAME
28591	1371	Driving Lever Spring.....
28592	1371	“ “ “ Collar.....
28593	1371	Frame.....
26718	1370	Needle Clamp Body.....
1943	1370	“ “ Roller.....
1115F	1370	“ “ Screw.....
26719	1370	Needle Clamp complete, Nos. 1115F, 1943 and 26718.....
28594	1371	Presser Foot (left).....
185H	1371	“ “ “ Screw.....
2532	1371	“ “ (right) Hinge Pin.....
28813	1371	“ “ “ Plate.....
28596	1371	“ “ “ Shank.....
28597	1371	“ “ “ “ Cap.....
198D	1371	“ “ “ “ “ Screw.....
2656	1371	“ “ “ “ Spring.....
706D	1371	“ “ “ “ Stop Screw.....
2521	1371	“ “ “ Spring.....
28814	—	Presser Foot (right) complete, Nos. 2521, 2532, 28596 and 28813.....
28815	1371	Ruffling Blade.....
24203	1371	“ “ Holder.....
226D	1371	“ “ “ Cap Screw.....
24204	1371	“ “ “ Spring.....
24205	1371	“ “ “ “ Stop.....
24206	1371	“ “ “ Stud.....
1550J	1371	“ “ “ “ Nut.....
28607	1371	“ “ “ Stop.....
28600	1371	“ “ Lever.....
560B	1371	“ “ “ Adjusting Thumb Screw.....
1603E	1371	“ “ “ “ “ “ “ Nut.....
1049D	1371	Ruffling Blade Lever Stop Screw.....
665D	1371	“ “ Screw.....
28601	1371	Starting Lever with 190D.....
190D	1371	“ “ Clamping Screw.....
28816	1370	Ruffler complete, Nos. 185H, 226D, 560B, 706D, 1049D, 1101C, 1550J, 1603E, 1647C, 2656, 24203 to 24206, 26719, 28590 to 28594, 28597, 28600, 28601, 28607, 28814, 28815, two 665D and three 198D.....
28603	1370	Feed Dog for 28816.....
28817	1370	Throat Plate for 28603.....
28605	1372	Edge Folder (upper, right hand) with left hand lower guide and separating blade on shank, to fold top band only, for making yokes, for 28816.....

NO.	PLATE	NAME
28818	1372	Double Edge Folder (right hand) with separating blade, for ruffling shirt body and putting in yoke, for 28816.....

SEAMER

NO.	PLATE	NAME
26657	—	Seamer, for umbrella work.....
26361	—	“ Edge Guide.....
26654	2032	“ Rivet.....
26653	2032	“ Shank.....
26658	2032	Seamer complete, Nos. 26361, 26653, 26654 and 26657.....

SEPARATING BLADE (Hinged)

FOR 44-22 MACHINE

NO.	PLATE	NAME
35279	2062	Separating Blade.....
35272	2061	“ “ Arm.....
35273	2061	“ “ “ Bracket.....
76D	2061	“ “ “ Hinge Screw.....
35274	2061	“ “ “ Latch Lever with 35275.....
102D	2061	Separating Blade Arm Latch Lever Hinge Screw.....
10135	2061	Separating Blade Arm Latch Lever Spring.....
239D	2061	“ “ “ “ “ “ “ Screw.....
35275	2061	Separating Blade Arm Latch Lever Stud.....
35276	2061	“ “ “ Holder.....
102D	2061	“ “ “ Hinge Screw.....
35277	2061	“ “ “ Spring.....
108D	2061	“ “ “ “ Screw.....
4604	2061	“ “ “ “ Stop Pin.....
14026	2061	“ “ “ Stop Pin.....
337D	2061	“ “ “ Screw.....
35280	—	Separating Blade (hinged) complete, Nos. 76D, 108D, 4604, 10135, 14026, 35272 to 35274, 35276, 35277, 35279, two each 102D, 239D and 337D.....
35283	2062	Edge Folder (lower, right hand) on Shank.....
35284	2064	“ “ (upper, left hand).....
217F	2061	“ “ Screw.....
35282	2064	“ Guide (upper, left hand).....
217F	2061	“ “ “ Screw.....
35285	2062	Presser Foot.....
35286	2062	Ruffling Blade.....

SPOOL HOLDER (Disc)

NO.	PLATE	NAME
26763	1352	Bracket with 219F and 287D.....
219F	774	" Screw.....
287D	2636	" Thumb Screw.....
19066	1352	Spindle.....
19067	1352	" Thread Guiding Disc.....
691F	782	" " " " Screw.....
26764	1352	Spool Holder (disc) complete, Nos. 691F, 19066, 19067 and 26763.....

THROAT PLATES

NO.	PLATE	NAME
26080	1383	Throat Plate Needle Plate for 26760 and 28342.....
337D	1383	Throat Plate Needle Plate Screw.....
26760	1383	" " with 337D and 26080, for 12369 or 12457, for underbraiding, for 44-1 and 44-13 Machines.....
28342	1383	Throat Plate with 337D and 26080, for 12450, for underbraiding, for 44-1 and 44-13 Machines.....
12450	1383	Feed Dog, 11 teeth (18 teeth to the inch) for 44-1, 44-13 and 44-20 Machines....
12369	1383	Feed Dog, 12 teeth (12 teeth to the inch)
12457	1383	" " 16 teeth (16 teeth to the inch)
28654	1383	Throat Plate, for underbraiding, for 12369 and 12457.....
19474	5813	Feed Dog.....
36906	5813	Throat Plate with under guide, for rick-rack, for 19474.....

TUBULAR TRIMMING ATTACHMENT

NO.	PLATE	NAME
35879	5643	Strip Wire.....
35880	5643	Feed Dog.....
35881	5643	Presser Foot (strip folding) with tube....
35018	5643	Tape Delivery Wire.....
35882	5643	Throat Plate for 35880.....
35883	—	Tubular Trimming Attachment complete, for making $\frac{1}{8}$ in., $\frac{3}{16}$ in. and $\frac{1}{4}$ in. trimmings, Nos. 35018 and 35879 to 35882

TUCKER

NO.	PLATE	NAME
26775	2036	Driving Lever.....
26129	2036	Foot.....

NO.	PLATE	NAME
26089	2036	Frame.....
5604	2036	" Rivet.....
26090	2036	Rocking Bar.....
26514	2036	" " Lifting Spring.....
26555	2036	" " Protector.....
26093	2036	Stop Bracket.....
26094	2036	Tuck Guide.....
658B	2036	" " Thumb Screw.....
26096	2036	" Marker Guide Clamp.....
561B	2036	" " " " Thumb Screw
26097	2036	" " " Rod.....
233B	2036	" " " " End Screw....
26095	2036	" Marking Plate.....
26098	2036	" Smoothing Spring.....
26517	2036	Tucker complete, Nos. 233B, 561B, 658B, 5604, 26089, 26090, 26093 to 26098, 26129, 26514, 26555 and 26775.....

TUCKER (Power)

NO.	PLATE	NAME
26099	2037	Bed.....
26100	2037	Cloth Guide.....
291D	2038	" " Thumb Screw.....
26101	2037	" " Slide with 26102 and two 26092.....
4604	2038	Cloth Guide Slide Rivet.....
401E	2038	" " " " Screw.....
26378	2037	Leveling Plate.....
12143	2037	Presser Foot.....
26368	2037	Tuck Marking Bar.....
26369	—	Tuck Marking Bar complete, Nos. 26368 and 26370 to 26372.....
26105	2037	Tuck Marking Bar Bracket.....
26106	2038	" " " " Hinge Pin....
220D	2038	" " " " " " Set Screw.....
26107	2037	Tuck Marking Bar Lifting Spring.....
26108	2037	" " " Pressure Spring.....
26109	2037	" " " " " " Clamp with 196F.....
196F	2038	Tuck Marking Bar Pressure Spring Clamp Set Screw.....
334D	2038	Tuck Marking Bar Set Screw.....
26370	2038	" " Pin.....
26371	2038	" " " Guide Pin.....
26372	2038	" " " Spring.....
26102	2037	" " Plate.....

NO.	PLATE	NAME
26092	2038	Tuck Marking Plate Rivet.....
26111	2037	" Smoothing Spring.....
4604	2038	" " " Rivet.....
26377	2037	Tucker complete, Nos. 220D, 291D, 334D, 401E, 12143, 26099 to 26101, 26105 to 26109, 26111, 26369, 26378 and three 4604.....
176D	2038	Tucker Screw.....

TUCKER (Long Arm)

FOR 44-1 AND 44-13 MACHINES

NO.	PLATE	NAME
26568	2635	Edge Guide.....
26569	2635	" " Slide.....
287D	2636	" " " Thumb Screw.....
7071	2636	" " " " " Washer..
939D	2636	" " " Thumb Screw.....
26597	—	Edge Guide complete, Nos. 287D, 7071, 26568 and 26569.....
26686	2636	Presser Foot.....
26570	2634	Tuck Guide Plate.....
26571	2634	" " " Arm with 5944.....
58D	2636	" " " " " Hinge Screw.....
26684	2634	" " " Bracket.....
732D	2636	" " " " " Thumb Screw
5944	2636	" " " Guide Pin.....
287D	2636	" " " Thumb Screw.....
7071	2636	" " " " " Washer
26683	—	Tuck Guide Plate complete, Nos. 58D, 287D, 732D, 7071, 26570, 26571, 26684 and two wood screws 1 in. No. 12.....
26685	—	Tucker complete, Nos. 939D, 26597, 26683 and 26686.....

NOTE: Bed Frame No. 24108 is used with,
but not included in, No. 26685.

TUCKER (Power)

FOR 44-20 MACHINE

This Tucker is the same as 26377 with the
following exceptions:

NO.	PLATE	NAME
26123	2037	Tuck Marking Bar Pressure Spring, in place of 26108.....

NO.	PLATE	NAME
26687	—	Tucker complete, Nos. 220D, 291D, 334D, 401E, 12143, 26099 to 26101, 26105 to 26107, 26109, 26111, 26123, 26369 and three 4604.....

UNIVERSAL FELLING ATTACHMENTS

NO.	PLATE	NAME
26604	2033	Universal Felling Attachment complete..
35100	2682	Universal Felling Attachment with First Seam Guide, complete.....
26603	2033	Feed Dog.....
28360	2033	" " (15 conical teeth).....
120001	1381	" " (spiked teeth).....
7298	1378	Presser Foot Hinge Pin.....
19334	—	" " Plate.....
19335	—	" " Shank.....
19336	1378	Presser Foot (hinged) complete, Nos. 7298, 19334 and 19335.....
26605	2033	Throat Plate, large needle hole, for 26603, 28360 and 120001.....
26606	—	Throat Plate, small needle hole, for 26603, 28360 and 120001.....

NOTE: Nos. 19336, 26603, 28360 or 120001, 26605 or
26606 are used with, but not included
in, Nos. 26604 or 35100

SEAMING GUIDE

Used with Universal Felling Attachment
No. 26604

NO.	PLATE	NAME
26777	1374	Arm.....
26778	1374	" Guide (upper).....
104D	1374	" " " Hinge Screw.....
26779	1374	" " " Spring.....
26780	1374	" Hinge Stud.....
26781	1374	" Locking Stud.....
26782	1374	" " " Spring.....
212D	1374	" Screw.....
26783	1374	Bracket with 196F.....
196F	1374	" Set Screw.....
26776	1374	Seaming Guide complete, Nos. 104D, 212D and 26777 to 26783.....

WELT GUIDE

(ADJUSTABLE) WITH SWITCH

NO.	PLATE	NAME
26143	2039	Bed
26144	2039	Cap
238D	2039	" Screw
26145	2039	Carrier
26146	—	" Slide
26344	2039	" " Stop
240D	2039	" " " Adjusting Screw
26147	2039	" Tongue
26148	—	Carrier complete, Nos. 233D, 26145 to 26147 and 26149
26138	2039	Carrier Slide Switch Cam with Shaft
26139	2039	" " " " Shaft Head with Lever with 337D
337D	2039	Carrier Slide Switch Cam Shaft Head Set Screw
910F	2039	Welt Guide Adjusting Screw
26149	2039	Width Guide
233D	2039	" " Screw
26150	2039	Welt Guide complete, Nos. 240D, 910F, 26138, 26139, 26143, 26144, 26148, 26344 and three 238D
190D	782	Welt Guide Screw
7071	2021	" " " Washer
26681	2039	Presser Foot
1928	2039	Roller, 1¼ in. diam., fine, with 386D and 1528J
16573	2039	Roller Arm
386D	5842	" Screw
1528J	5842	" " Nut
19394	—	Roller Presser complete, 1¼ in. fine roller, Nos. 1928 and 16573

NOTE: Presser Foot No. 26681 and Roller Presser No. 19394 are used with, but not included in, No. 26150.

BOBBIN WINDERS

BOBBIN WINDER

FOR 4370

NO.	PLATE	NAME
15072	2014	Bobbin Position Pin
12168	2003	Bracket
692D	783	" Screw

BOBBIN WINDERS

NO.	PLATE	NAME
12169	2003	Frame
12171	2003	Frame complete, Nos. 333D, 5960, 5961, 5963, 12169 and 15077
32D	782	Frame Hinge Screw
5960	768	Friction Wheel (leather)
5961	768	" " Washer
333D	782	" " " Screw
15077	773	Spindle with 15072
5963	768	" Flange
12170	773	Spring
180F	782	" Screw
12172	—	Bobbin Winder complete, Nos. 32D, 180F, 12168, 12170 and 12171

BOBBIN WINDER

FOR 2135 AND 2862

This Bobbin Winder is the same as 12172 with the following exceptions:

NO.	PLATE	NAME
12201	2003	Frame complete, Nos. 333D, 5960, 5961, 5963, 12169 and 15077, in place of 12171
12202	—	Bobbin Winder complete, Nos. 32D, 180F, 12168, 12170 and 12201

BOBBIN WINDER

FOR 12358

This Bobbin Winder is the same as 12172 with the following exceptions:

NO.	PLATE	NAME
20307	8381	Frame, in place of 12169
20308	1311	Frame complete, Nos. 333D, 5960, 5961, 5963, 15077 and 20307, in place of 12171
20309	—	Bobbin Winder complete, Nos. 32D, 180F, 12168, 12170 and 20308

BOBBIN WINDER

(HAMBURG)

FOR 2135 AND 2862

This Bobbin Winder is the same as 12172 with the following exceptions:

NO.	PLATE	NAME
43981	6119	Frame, in place of 12169
43982	6119	Frame complete, Nos. 5960, 5961, 5963, 12336, 15077 and 43981, in place of 12171

NO.	PLATE	NAME
12336	2003	Spindle for spool, in place of 333D.....
12337	—	Bobbin Winder complete, Nos. 32D, 180F, 12168, 12170 and 43982.....

BOBBIN WINDER

(HAMBURG)

FOR 4370

This Bobbin Winder is the same as 12172 with the following exceptions:

NO.	PLATE	NAME
43981	6119	Frame, in place of 12169.....
43983	6119	Frame complete, Nos. 5960, 5961, 5963, 12336, 15077 and 43981, in place of 12171.....
12336	2003	Spindle for spool, in place of 333D.....
20498	—	Bobbin Winder complete, Nos. 32D, 180F, 12168, 12170 and 43983.....

BOBBIN WINDER

(SWINGING AUTOMATIC, RIGHT HAND)

FOR 2996

FOR POWER TABLE

NO.	PLATE	NAME
27552	1162	Base.....
15072	2014	Bobbin Position Pin.....
27302	1162	Frame.....
50356D	5806	" Hinge Screw.....
1620J	5806	" " " Nut.....
27303	773	" Spring.....
27553	1162	Pulley.....
27538	1162	Spindle with 15072.....
27306	1162	Spool Pin.....
27307	1162	" Stand.....
27308	1162	Spool Stand complete, Nos. 418E, 1562J, 2106, 10141, 11241, 27306, 27307 and two each 2455 and wood screws 1 in. No. 10.....
11241	2003	Spool Washer (cloth).....
27312	2003	Stop Latch.....
35D	1366	" " Hinge Screw.....
2455	2014	Tension Disc.....
1562J	2014	" Regulating Thumb Nut.....
418E	2014	" Screw Stud.....
10141	2014	" Spring.....
2106	2014	" Thread Guide.....

NO.	PLATE	NAME
27650	—	Bobbin Winder, Nos. 35D, 1620J, 27302, 27303, 27312, 27538, 27552, 27553, 50356D and two wood screws 1 in. No. 7
27554	—	Bobbin Winder (swinging automatic, right hand) complete, Nos. 27308 and 27650

BOBBIN WINDER

(SWINGING AUTOMATIC, RIGHT HAND)

FOR 2996

FOR STAND

This Bobbin Winder is the same as 27554 with the following exceptions:

NO.	PLATE	NAME
27540	2445	Base, in place of 27552.....
27541	2445	Pulley, in place of 27553.....
27647	2445	Bobbin Winder, Nos. 35D, 1620J, 27302, 27303, 27312, 27538, 27540, 27541, 50356D and two wood screws 1 in. No. 7, in place of 27650.....
27544	—	Bobbin Winder (swinging automatic, right hand) complete, Nos. 27308 and 27647

BOBBIN WINDER

(SWINGING AUTOMATIC, RIGHT HAND)

FOR 19131

FOR POWER TABLE

This Bobbin Winder is the same as 27554 with the following exceptions:

NO.	PLATE	NAME
27587	1162	Stop Latch, in place of 27312.....
27651	1162	Bobbin Winder, Nos. 35D, 1620J, 27302, 27303, 27538, 27552, 27553, 27587, 50356D and two wood screws 1 in. No. 7, in place of 27650.....
27588	—	Bobbin Winder (swinging automatic, right hand) complete, Nos. 27308 and 27651

BOBBIN WINDER

(SWINGING AUTOMATIC, RIGHT HAND)

FOR 19131

FOR STAND

This Bobbin Winder is the same as 27554 with the following exceptions:

NO.	PLATE	NAME
27540	2445	Base, in place of 27552.....

NO.	PLATE	NAME
27541	2445	Pulley, in place of 27553
27587	1162	Stop Latch, in place of 27312
27875	—	Bobbin Winder, Nos. 35D, 1620I, 27302, 27303, 27538, 27540, 27541, 27587, 50356D and two wood screws 1 in. No. 7, in place of 27650
27876	—	Bobbin Winder (swinging automatic, right hand) complete, Nos. 27308 and 27875

BOBBIN WINDER

(SWINGING AUTOMATIC, RIGHT HAND)
FOR 24051 FOR 44-20 MACHINE

This Bobbin Winder is the same as 27554 with the
following exceptions:

NO.	PLATE	NAME
27699	2003	Stop Latch, in place of 27312
27700	—	Bobbin Winder, Nos. 35D, 1620I, 27302, 27303, 27538, 27552, 27553, 27699, 50356D and two wood screws 1 in. No. 7, in place of 27650
27701	—	Bobbin Winder (swinging automatic, right hand) complete, Nos. 27308 and 27700

BOBBIN WINDER

(SWINGING AUTOMATIC, RIGHT HAND)
FOR 2996, 19131 AND 24051
FOR POWER TABLE

NO.	PLATE	NAME
*225451	—	Bobbin Holder
225463	3469	" Winder and Tension Bracket Base
225453	3470	Frame with 202277 and 225438
225454	3471	" Hinge Pin
202277	3471	" Oil Packing (wick)
225438	3471	" " Well Cap
225455	3471	" Spring
225456	3471	" " Plunger
202473	3470	Pulley with 200380c
200380c	3471	" Set Screw
*225443	—	Spindle
225452	3470	" 225443 with 225451
225444	3471	Stop Latch
200056E	3471	" " Screw
225458	3471	" " Thumb Lever
225459	3471	" " " " Hinge Stud
225460	3471	" " " " Joint Stud
202478	3471	" " Trip Lever

NO.	PLATE	NAME
200299H	3471	Stop Latch Trip Lever Hinge Screw
225461	3471	Tension Bracket with 201499B
200082D	3471	" " " Screw
202104	3471	" " " Washer
2102	3471	" Disc
202407	3471	" Spring
201499B	3471	" Stud
201572B	3471	" " Thumb Nut
225462	—	Tension Bracket complete, Nos. 201572B, 202407, 225461 and two 2102
225436	3469	Bobbin Winder (swinging automatic, right hand) complete, Nos. 200056E, 200082D, 200299H, 202104, 202473, 202478, 225444, 225452 to 225456, 225458 to 225460, 225462, 225463 and two wood screws ¾ in. No. 13 R. H. B.

DRIVING ATTACHMENT

FOR 44-1 TO 44-3, 44-8, 44-9, 44-23, 44-28, 44-72
AND 44-75 MACHINES

NO.	PLATE	NAME
16592	1230	Balance Wheel (friction) with 7958, 16524 and two 435c
16524	—	Balance Wheel Friction Ring (leather)
7958	5843	" " " " Stop Pin
24355	1315	" " Oil Cover
210D	1343	" " " Screw
435c	5806	" " Set Screw
15072	2014	Bobbin Position Pin for 15077
16514	768	" Winder Frame
32D	782	" " " Hinge Screw
16515	768	Bobbin Winder Frame complete, Nos. 333D, 5960, 5961, 5963, 15077 and 16514
5960	768	Bobbin Winder Friction Wheel (leather)
5961	768	" " " " Washer
333D	782	" " " " " Screw
15077	773	" " Spindle with 15072
5963	768	" " " Flange
27306	1162	" " Spool Pin
27307	1162	" " Stand
27308	1162	Bobbin Winder Spool Stand complete, Nos. 418E, 1562J, 2106, 10141, 11241, 27306, 27307 and two each 2455 and wood screws 1 in. No. 10
11241	2003	Bobbin Winder Spool Washer (cloth)
12170	773	" " Spring

NO.	PLATE	NAME
180F	782	Bobbin Winder Spring Screw.....
16516	774	“ “ Stop Latch with 152F and 1550J.....
152F	782	Bobbin Winder Stop Latch Adjusting Screw.....
1550J	783	Bobbin Winder Stop Latch Adjusting Screw Nut.....
75D	782	Bobbin Winder Stop Latch Hinge Screw...
27303	773	“ “ “ “ Spring.....
2269	773	“ “ “ “ Stop Pin.....
2455	2014	“ “ Tension Disc.....
1562J	2014	“ “ “ Regulating Thumb Nut.....
418E	2014	Bobbin Winder Tension Screw Stud.....
10141	2014	“ “ “ Spring.....
2106	2014	“ “ “ Thread Guide...
16530	1230	Bracket.....
692D	783	“ Screw.....
16528	1230	Drip Pan with four 1 in. wire nails.....
16518	1230	Driving Arm with 2269, 2928 and two 15132.....
2928	774	Driving Arm Brake (leather).....
15132	773	“ “ “ Rivet.....
12178	774	“ “ Friction Plug (wood).....
427E	783	“ “ “ Adjusting Screw.....
1508c	783	Driving Arm Friction Plug Adjusting Screw Nut.....
693D	782	Driving Arm Hinge Screw.....
1579c	783	“ “ “ “ Nut.....
16519	1348	“ “ Pitman.....
16520	768	“ “ “ Crank with 803c and 1520E.....
803c	782	Driving Arm Pitman Crank Adjusting Screw.....
1520E	783	Driving Arm Pitman Crank Adjusting Screw Nut.....
2022	773	Driving Arm Pitman Crank Pin.....
16521	768	“ “ “ “ Spring.....
24528	8381	“ “ “ “ Adjusting Collar with three 448c.....
448c	783	Driving Arm Pitman Crank Spring Adjusting Collar Set Screw.....
65D	782	Driving Arm Pitman Hinge Screw.....

NO.	PLATE	NAME
16522	—	Driving Arm complete, Nos. 32D, 75D, 180F, 427E, 693D, 1508c, 1579c, 12170, 12178, 16515, 16516, 16518, 16530 and 27303.....
16594	1230	Driving Friction Pulley, 2 $\frac{3}{8}$ in. diam., with 861D and two 10236.....
10236	774	Driving Friction Pulley Centre Bearing...
861D	5742	“ “ “ Oil Hole Plug Screw
27072	—	Shaft Driving Pulley (sectional grooved) 12 in. diam., 1 $\frac{3}{8}$ in. bore, with two 597c
597c	—	Shaft Driving Pulley Clamping Screw....
12189	768	Starting Crank.....
2022	773	“ “ Pin.....
16525	1350	“ “ Shaft.....
24529	8381	“ “ “ Bracket with 24528
130D	782	“ “ “ “ Screw....
24530	—	Starting Crank Shaft Bracket complete, Nos. 12189, 16520, 16521, 16525, 24529 and two 2022.....
27636	363	Treadle.....
9082	773	“ Bearing Cotter Pin.....
27637	1230	“ Pitman Rod (lower).....
27638	5841	“ “ “ “ Spring.....
6055	5843	“ “ “ “ Washer
2877	1230	“ “ “ (upper) for 15130...
14081	1230	“ “ “ “ “ 14233...
9079	2638	“ “ “ Clamp with 354c...
354c	2638	“ “ “ “ Screw.....
15130	1230	Treadle Pitman complete, Nos. 2762, 2877, 6055, 9079, 27637 and 27638.....
14233	1230	Treadle Pitman complete, for bench stand, Nos. 2762, 6055, 9079, 14081, 27637 and 27638.....
2878	363	Treadle Stand.....
27642	—	Treadle complete, Nos. 2878, 9082, 27636 and four wood screws 1 in. No. 16....
15131	—	Treadle and Pitman complete, Nos. 15130 and 27642.....
14234	—	Treadle and Pitman complete, Nos. 14233 and 27642.....
2762	1206	Treadle Stop Collar with 362F.....
362F	2009	“ “ “ Set Screw.....
16531	—	Driving Attachment with Bobbin Winder and Treadle complete, Nos. 210D, 692D, 14234 or 15131, 16519, 16522, 16592, 16594, 24355, 24530, 27072, 27308, two 65D and three 130D.....

DRIVING ATTACHMENT

FOR 44-13, 44-17, 44-20, 44-22, 44-24, 44-29 AND
44-74 MACHINES

This Driving Attachment is the same as 16531 with the
following exceptions:

NO.	PLATE	NAME
19258	2009	Bobbin Winder Stop Latch with 152F and 1550J, in place of 16516.....
19260	—	Driving Arm complete, Nos. 32D, 75D, 180F, 427E, 693D, 1508C, 1579C, 12170, 12178, 16515, 16518, 16530, 19258 and 27303, in place of 16522.....
24073	—	Driving Attachment with Bobbin Winder and Treadle complete, Nos. 210D, 692D, 14234 or 15131, 16519, 16592, 16594, 19260, 24355, 24530, 27072, 27308, two 65D and three 130D.....

FOOT LEVER PARTS

NO.	PLATE	NAME
24378	2637	Foot Lever with two 1157c.....
24379	2637	" " 24378 with 5671, 24380, 24381 and four wood screws 1 in. No. 12.....
24380	2637	Foot Lever Bracket.....
5671	2638	" " Hinge Pin.....
24381	2637	" Rest with 24382.....
24382	2638	" " Pin.....
1157c	2638	" " Set Screw.....
24383	2637	Pitman Rod (lower) 17 in. long.....
24384	2638	" " " Stop Collar with 1157c.....
1157c	2638	" " " Set Screw.....
24385	2637	" " (upper) 17 in. long, with 2761.....
2761	2638	" " Cap.....
24386	2637	" " Guide Bracket with three wood screws 1 in. No. 12.....
9079	2638	Pitman Rod Clamp with 354c.....
354c	2638	" " " Screw.....
24387	—	Foot Lever complete, Nos. 9079, 24379, 24383, 24385, 24386 and two 24384.....

FOOT LIFTER PARTS

NO.	PLATE	NAME
5596	768	Bell Crank.....
56848	—	" " 5596 with 5599 and 5601.....
5599	768	" " Bracket.....

FOOT LIFTER PARTS

NO.	PLATE	NAME
178E	782	Bell Crank Bracket Screw.....
5601	773	" " Hinge Pin.....
5735	1353	" " Spring.....
5598	768	Bell Crank complete, Nos. 5735 and 56848.....
5670	—	Chain, length 26 in. to 35 in.....
NOTE: When ordering No. 5670, state length required.		
4879	2004	Chain Connecting Link.....
16510	766	Lifting Lever with 448c, for 19331.....
16585	1315	" " " " " 24426.....
19371	1311	" " " " " 24427, 62573 and 62697.....
12415	768	Lifting Lever Connecting Rod for 19331, 24426, 24427 and 62573.....
20255	8381	Lifting Lever Connecting Rod for 62697.....
12416	774	" " " " Joint.....
76D	782	" " " " Hinge Screw.....
1521E	772	Lifting Lever Connecting Rod Lock Nut.....
802D	782	" " Hinge Screw.....
12241	772	" " Link for 19331 and 24426.....
21301	1353	" " " " 24427, 62573 and 62697.....
766D	782	Lifting Lever Link Hinge Screw.....
12240	772	" " Pin for 19331.....
16586	5843	" " " " 24426.....
19372	1313	" " " " 24427 and 62697.....
62572	8381	" " " " 62573.....
448c	783	" " " Set Screw.....
2763	1231	Rock Shaft.....
12242	1231	" " Hanger with two wood screws 1 in. No. 10.....
6337	1231	Rock Shaft Lifting Bracket with two 356c.....
12243	1231	" " " " Hook for 4880.....
7125	1231	" " " " " ".....
356c	783	" " " " " Set Screw.....
356c	783	" " " " " Set Screw.....
2770	1231	" " Stop Dog with 356c.....
356c	783	" " " " " Set Screw.....
4880	1231	Rock Shaft complete, Nos. 2763, 2770, 7125, 12243 and two each 6337 and 12242.....
4881	1231	Treadle.....
4882	2004	" Shaft.....
4883	2004	" Spring.....
4884	1231	" Stand.....

NO.	PLATE	NAME
4885	1231	Treadle complete, Nos. 4879, 4881 to 4884 and two wood screws 1 in. No. 16.....
19331	—	Foot Lifter complete for 44-1 to 44-3, 44-13, 44-17, 44-20, 44-22, 44-24 and 44-29 Machines, Nos. 76d, 766d, 802d, 1521E, 4880, 4885, 5598, 5670, 12240, 12241, 12415, 12416, 16510 and two 178E.....
24426	—	Foot Lifter complete for 44-8 and 44-28 Machines, Nos. 76d, 766d, 802d, 1521E, 4880, 4885, 5598, 5670, 12241, 12415, 12416, 16585, 16586 and two 178E.....
24427	—	Foot Lifter complete for 44-9 and 44-23 Machines, Nos. 76d, 766d, 802d, 1521E, 4880, 4885, 5598, 5670, 12415, 12416, 19371, 19372, 21301 and two 178E.....
62573	—	Foot Lifter complete for 44-75 Machine, Nos. 76d, 766d, 802d, 1521E, 4880, 4885, 5598, 5670, 12415, 12416, 19371, 21301, 62572 and two 178E.....
62697	—	Foot Lifter complete for 44-72 Machine, Nos. 76d, 766d, 802d, 1521E, 4880, 4885, 5598, 5670, 12416, 19371, 19372, 20255, 21301 and two 178E.....

KNEE LIFTER PARTS

NO.	PLATE	NAME
5596	768	Bell Crank.....
56848	—	“ “ 5596 with 5599 and 5601.....
5599	768	“ “ Bracket.....
178E	782	“ “ “ Screw.....
5601	773	“ “ Hinge Pin.....
5735	1353	“ “ Spring.....
5598	768	Bell Crank complete, Nos. 5735 and 56848
16510	766	Lifting Lever with 448c, for 16512 and 24161.....
19371	1311	Lifting Lever with 448c, for 19373, 24482 and 62574.....
16585	1315	Lifting Lever with 448c, for 16587.....
12415	768	“ “ Connecting Rod for 16512, 16587, 19373, 24161 and 62574.....
20255	8381	Lifting Lever Connecting Rod for 24482...
12416	774	“ “ “ “ Joint.....
76D	782	“ “ “ “ “ Hinge Screw.....
1521E	772	Lifting Lever Connecting Rod Lock Nut..

NO.	PLATE	NAME
802D	782	Lifting Lever Hinge Screw.....
12241	772	“ “ Link for 16512, 16587 and 24161.....
21301	1353	Lifting Lever Link for 19373, 24482 and 62574.....
766D	782	Lifting Lever Link Hinge Screw.....
12240	772	“ “ Pin for 16512 and 24161...
16586	5843	“ “ “ “ 16587.....
19372	1313	“ “ “ “ 19373 and 24482...
62572	8381	“ “ “ “ 62574.....
448c	783	“ “ “ “ Set Screw.....
2759	1348	“ Rod with 2761.....
2761	2638	“ “ Cap (washer).....
2762	1206	“ “ Collar with 362c.....
362c	2009	“ “ “ “ Set Screw.....
2760	—	Lifting Rod complete for 19168, Nos. 2759 and 2762.....
2763	766	Rock Shaft.....
12242	766	“ “ Hanger with two wood screws 1 in. No. 10.....
2765	766	Rock Shaft Knee Arm for 2768.....
6335	1348	“ “ “ “ “ 6336.....
2766	766	“ “ “ “ Hub with 356c...
356c	783	“ “ “ “ “ Set Screw...
2768	—	Rock Shaft Knee Arm complete for 2777, Nos. 2765 to 2767.....
6336	—	Rock Shaft Knee Arm complete for 19168, Nos. 2766, 2767 and 6335.....
2767	766	Rock Shaft Knee Plate with 356c.....
356c	783	“ “ “ “ Set Screw.....
2769	1348	“ “ Lifting Arm with 356c.....
356c	783	“ “ “ “ Set Screw.....
6337	766	“ “ “ Bracket with two 356c
2778	766	“ “ “ “ Hook.....
356c	783	“ “ “ “ “ Set Screw
356c	783	“ “ “ “ Set Screw.....
2770	766	“ “ Stop Dog with 356c.....
356c	783	“ “ “ “ Set Screw.....
2777	766	Rock Shaft complete for 16512, 16587, 19373, 24482 and 62574, Nos. 2763, 2768, 2770, 2778, 6337 and two 12242
19168	—	Rock Shaft complete for 24161, Nos. 2760, 2763, 2769, 6336 and two each 2770 and 12242.....

NO.	PLATE	NAME
16512	—	Knee Lifter complete (power table) for 44-1 to 44-3, 44-17, 44-20, 44-22, 44-24 and 44-29 Machines, Nos. 76D, 766D, 802D, 1521E, 2777, 5598, 12240, 12241, 12415, 12416, 16510 and two 178E.....
16587	—	Knee Lifter complete (power table) for 44-8 and 44-28 Machines, Nos. 76D, 766D, 802D, 1521E, 2777, 5598, 12241, 12415, 12416, 16585, 16586 and two 178E.....
19373	—	Knee Lifter complete (power table) for 44-9 and 44-23 Machines, Nos. 76D, 766D, 802D, 1521E, 2777, 5598, 12415, 12416, 19371, 19372, 21301 and two 178E.....
24161	—	Knee Lifter complete (bench stand) for 44-1 to 44-3, 44-13, 44-17, 44-20, 44-22, 44-24 and 44-29 Machines, Nos. 76D, 766D, 802D, 1521E, 5598, 12240, 12241, 12415, 12416, 16510, 19168 and two 178E.....
24482	—	Knee Lifter complete (power table) for 44-72 Machine, Nos. 76D, 766D, 802D, 1521E, 2777, 5598, 12416, 19371, 19372, 20255, 21301 and two 178E.....
62574	—	Knee Lifter complete (power table) for 44-75 Machine, Nos. 76D, 766D, 802D, 1521E, 2777, 5598, 12415, 12416, 19371, 21301, 62572 and two 178E.....

KNIFE GRINDER

FOR 5726

NO.	PLATE	NAME
27565	1104	Emery Wheel, 2 in. diam.....
1508c	1105	" " Clamping Nut.....
27822	1105	" " " " Washer.....
27567	1105	" " Shaft.....
60934	—	" " " 27567 with 1508E, 27565, 27569 and 27822.....
27568	1105	Emery Wheel Shaft Oil Hole Cover (rubber).....
27569	1105	Emery Wheel Shaft Pulley.....
310F	1105	" " " " Screw Centre.....
1516D	1105	" " " " " Nut.....
27564	1104	Frame with 27574.....
899D	1105	Knife Clamping Screw.....
27657	—	" Holder Body for 27658.....
27679	—	" " " " 27681.....
27680	—	" " " " 27682.....

NO.	PLATE	NAME
27658	1105	Knife Holder complete for 5726 for 27661, Nos. 899D, 27657 and 27660.....
27681	6255	Knife Holder complete, Nos. 899D, 11833, 27660 and 27679.....
27682	6255	Knife Holder complete, Nos. 899D, 11833, 27660 and 27680.....
27323	1105	Knife Holder Guide Bar.....
27572	1104	" " " " Bracket with 27574.....
310F	1105	Knife Holder Guide Bar Bracket Screw Centre.....
1516D	1105	Knife Holder Guide Bar Bracket Screw Centre Nut.....
27573	1105	Knife Holder Guide Bar Bracket Spring.....
27574	1105	" " " " " " " Hook.....
27659	1105	Knife Holder Stop Collar with 237F.....
237F	1105	" " " " " " Set Screw.....
27660	6255	" Position Pin for 27658.....
27660	6255	" " " (lower) for 27681 and 27682.....
11833	6255	Knife Position Pin (upper) for 27681 and 27682.....
261D	1105	Knife Regulating Thumb Screw.....
60583	—	Knife Grinder, Nos. 261D, 27323, 27564, 27572, 27573, 27659, 60934, two 27568 and four each 310F and 1516D.....
27661	—	Knife Grinder complete, Nos. 27662, 60583, either 27658, 27681 or 27682 and three wood screws 1 in. No. 10.....
27662	1104	Wrench for 1508 and 1516.....

STAND

ROCKING TREADLE, BALL BEARING PITMAN

NO.	PLATE	NAME
25301	3825	Band Wheel, 16 in. diam., with 972C.....
46519	3825	" " Crank.....
46520	—	Band Wheel Crank and Pitman (ball bearing) complete, Nos. 1520R, 25371, 46506 to 46509, 46519, 46523, 46630, 46655 and six 25362.....
296c	3826	Band Wheel Crank Screw Centre.....
46661	—	" " " " " " 296c with 1507J.....
1507J	3826	Band Wheel Crank Screw Centre Nut.....
972c	3826	" " Set Screw.....

NO.	PLATE	NAME
46522	3825	Leg
25362	3826	Pitman Ball, size $\frac{3}{8}$ in.
46506	3826	" " Bearing Adjusting Screw Ring
46507	3826	" " " " " " " "
		Locking Washer (brass)
46508	3826	Pitman Ball Bearing Ring
46509	3826	" " Case
46655	3826	" " Separator
46658	5843	" Rod (lower) with 25360
*25360	—	" " " Ball
25371	3825	" " " Bushing
25361	3826	" " " " Screw Bearing
46630	—	" " " " " " " "
		25361 with 1670E
1670E	3826	Pitman Rod (lower) Ball Screw Bearing Nut
46659	5841	Pitman Rod (upper)
1520R	3826	" " " Lock Nut
46660	5843	" " Coupling
46524	3825	Treadle
297C	3826	" Screw Centre
46629	—	" " " 297c with 1507J
1507J	3826	" " " Nut
10875	5841	Wrench for 46660
25086	3825	" " 1507 and 1670
25200	3825	" " 972
25284	—	Stand (iron work) rocking treadle, ball bearing pitman, complete, Nos. 10875, 25086, 25200, 25301, 46524, 46533, 46656, two 46522 and four 748E
67175	5843	Hook for 67072
67176	8383	Treadle Pitman Rod (lower)
67086	8383	" " " (upper)
9079	8383	" " " Clamp with 354c
354c	774	" " " " Screw
67177	8383	Treadle Pitman complete, Nos. 9079, 67086 and 67176

TRIMMINGS FOR END AND BACK LEAF TABLE

NO.	PLATE	NAME
25001	3825	Back Leaf Bracket with two wood screws 1 in. No. 10
25002	3825	Back Leaf Scroll Bracket with $\frac{3}{4}$ in. No. 9 and two 1 in. No. 12 wood screws

NO.	PLATE	NAME
25003	3825	Back Leaf Sliding Hinge, Nos. 25149, three 25151 and six wood screws $\frac{3}{4}$ in. No. 8
25151	3825	Back Leaf Sliding Hinge Plate
25149	3825	" " " " Rod
25057	3825	End Leaf Support complete, Nos. 25143, 25168, 25169 and two wood screws $\frac{5}{8}$ in. No. 7
25168	3825	End Leaf Support Bracket
25060	3825	" " " Button with wood screw 1 $\frac{1}{2}$ in. No. 12 R. H. B.
25169	3825	End Leaf Support Lever
25143	5742	" " " " Hinge Pin
20022	5742	Machine Rest (felt) for machine on stand

THREAD UNWINDERS

THREAD UNWINDER

FOR ONE LARGE SPOOL OR ONE LARGE CONE OF
THREAD

NO.	PLATE	NAME
27623	2836	Spool Pin
155c	5843	" " Set Screw
41526	2836	" Rest
60701	—	" " 41526 with 155c and 1149c
41527	—	" " 60701 with 27623
1149c	5742	" " Set Screw
27940	2836	" Stand with 453c
41514	2836	" Weight, 4 in. diam., with 41515
41515	5742	" " Centre Pin
27739	2836	Thread Cone (wood)
41630	2836	" Guard with 208E and 41569
41569	5842	" " Eyelet
41637	2836	" " Rod (lower)
41638	2836	" " " (upper)
41639	2836	" " " Coupling with two 456c
456c	773	" " " " Set Screw
41640	—	Thread Guard Rod complete, 30 in. long, Nos. 41637 to 41639
453c	783	Thread Guard Rod Set Screw
208E	782	" " " Screw
41529	2836	Thread Unwinder complete, Nos. 27739, 27940, 41514, 41527, 41630, 41640 and three wood screws 1 in. No. 12

THREAD UNWINDER

FOR TWO LARGE SPOOLS OR TWO LARGE CONES OF THREAD

NO.	PLATE	NAME
27623	2837	Spool Pin.....
155c	5843	“ “ Set Screw.....
41530	2837	“ “ Rest.....
60455	—	“ “ 41530 with 1149c and two 155c
41531	—	“ “ 60455 with two 27623.....
1149c	5742	“ “ Set Screw.....
27940	2837	“ Stand with 453c.....
41514	2837	“ Weight, 4 in. diam., with 41515....
41515	5742	“ “ Centre Pin.....
27739	2837	Thread Cone (wood).....
41631	2837	“ Guard with 208E and two 41569
41569	5842	“ “ Eyelet.....
41637	2837	“ “ Rod (lower).....
41638	2837	“ “ “ (upper).....
41639	2837	“ “ “ Coupling with two 456c
456c	773	“ “ “ Set Screw.....
41640	—	Thread Guard Rod complete, 30 in. long, Nos. 41637 to 41639.....
453c	783	Thread Guard Rod Set Screw.....
208E	782	“ “ Screw.....
41533	2837	Thread Unwinder complete, Nos. 27940, 41531, 41631, 41640, two each 27739, 41514 and three wood screws 1 in. No. 12

OBSOLETE PARTS

NO.	PLATE	NAME
26755	953	Adjustable Edge and Strip Guide with Separating Blade complete for 44-22 Machine.....
16532	1369	Arm Dowel Pin.....
16502	—	“ Shaft for 44-1 Machine.....
19219	1206	Bed Frame Cushion (leather) for 19218 and 19399.....
12405	774	Bed Frame Cushion (felt) for 16554.....
180c	782	“ “ “ Screw.....
19220	1206	“ “ “ Spring for 19218 and 19399.....
19226	1206	Bed Frame Hinge Connection for 19228 and 19398.....
19227	1369	Bed Frame Hinge Connection Cap for 19228, use 19397.....

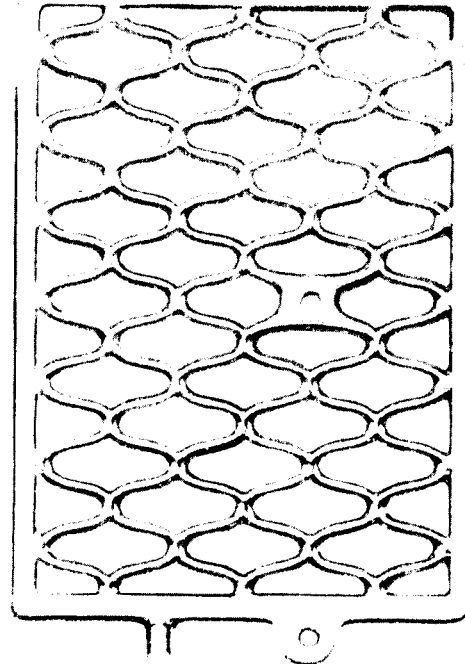
NO.	PLATE	NAME
19397	1206	Bed Frame Hinge Connection Cap for 19398.....
211F	1206	Bed Frame Hinge Connection Cap Screw
19228	—	Bed Frame Hinge Connection complete, Nos. 211F, 19226 and 19227, use 19398
19398	—	Bed Frame Hinge Connection complete for 19399, Nos. 211F, 19226 and 19397
16555	1206	Bed Frame Hinge Plate for 16554, 19218 and 19399.....
14010	1206	Bed Frame Hinge Plate Rivet.....
16554	—	“ “ with two 16555, four each 180c, 12405 and six wood screws 1¼ in. No. 10, use 24108.....
19218	—	Bed Frame with two 16555, four each 19219, 19220, six each 14010, wood screws 1¼ in. No. 10 and eight 158c, use 24108.....
19399	1231	Bed Frame complete, Nos. 970D, two each 16555, 19398, four each 19219, 19220, six each 14010, wood screws 1¼ in. No. 10 and eight 158c, use 24108.....
5602	772	Bell Crank Spring for 5598.....
12484	2003	Bobbin Winder Spring for 12172, 12202 and 12337.....
12365	1350	Crank Connecting Rod with 14013 and two 896E, for 375.....
12496	1350	Crank Connecting Rod with 14013 and two 896E, for 908, use 20197.....
*14013	—	Crank Connecting Rod Cap for 12365 and 12496.....
375c	782	Crank Connecting Rod Hinge Screw.....
1518E	783	“ “ “ “ “ Nut for 375.....
24030	—	Face Plate.....
24031	1351	Face Plate complete for 44-20 Machine, Nos. 934E, 9545, 12150, 12152, 24030, 24033, 24072 and two 24032.....
24032	1369	Face Plate Thread Retainer Disc.....
24072	1369	“ “ “ “ “ Cover
934E	—	“ “ “ “ “ Screw.....
9545	1369	Face Plate Thread Retainer Disc Spring..
24033	1369	“ “ “ “ Thread Guard
20009	1258	Feed Dog, for tailor work, for 44-1 Machine
12371	779	“ “ “ shirt work, for 44-2 Machine
19400	1268	“ “ “ “ “ 44-13 Machine, use 20117.....

NO.	PLATE	NAME
19225	1308	Presser Foot (hinged) complete for 12425, 19474 and 20119, Nos. 2532, 19223 and 19224, use 24546
24545	—	Presser Foot Shank
24546	780	Presser Foot (spring hinged) complete for 12425, 19474 and 20119, Nos. 24544, 24545, 26231 and 62527, use 24983
24198	1369	Ruffling Arm with 190D, for 44-22 Machine, use 26890
24307	1369	Ruffling Arm with 190D, for 44-22 Machine, use 26890
24209	1324	Ruffling Eccentric Connection for 44-22 Machine
24117	2006	Shuttle Bobbin Case Guide Plate for 24120 and 24121
1053D	2006	Shuttle Bobbin Case Guide Plate Screw for 24120 and 24121
15003	771	Shuttle Bobbin Case Hinge for 12417 and 19293, Nos. 2972 to 2974
20595	2012	Shuttle Bobbin Case Position Finger for 20651
12417	—	Shuttle Bobbin Case complete for 12392, Nos. 591F, 592E, 2523, 2526, 2975, 7553 and 15003, use 19293
19293	771	Shuttle Bobbin Case complete for 19292, Nos. 591F, 592E, 2523, 2975, 7553, 15003 and 15098, use 24074
20651	2012	Shuttle Bobbin Case complete for 20655, Nos. 591F, 592E, 2523, 2975, 20595, 20650 and 20654
20596	2012	Shuttle Body for 20655
19401	—	“ Driver for 44-13 Machine, use 19406
12392	—	Shuttle, 1 $\frac{1}{8}$ in. diam., Nos. 2996, 12393 and 12417, use 19292
20655	2012	Shuttle, 1 $\frac{1}{8}$ in. diam., Nos. 19131, 20596 and 20651, for 44-13, 44-17, 44-22 and 44-24 Machines
648D	782	Shuttle Race Back Spring Screw
19402	—	“ “ Body for 19404
19489	—	“ “ “ “ 19490
24008	—	“ “ “ “ 62623
24011	—	“ “ “ “ 24012
24118	—	“ “ “ “ 24120
24119	—	“ “ “ “ 24121
5708	—	“ “ “ “ 5707
19187	—	“ “ “ “ 19188

NO.	PLATE	NAME
24063	—	Shuttle Race Body for 24065
62623	—	“ “ “ 24008 with 24009 and two 1053D for 24101
5709	767	Shuttle Race Cap for 5707 and 19188
19403	2006	“ “ “ “ 19101 and 19490
4621	2442	“ “ “ Steady Pin for 19404 and 19490
5707	767	Shuttle Race complete for 44-1, 44-2, 44-8 and 44-23 Machines, Nos. 648D, 2531, 2533, 5708, 5709 and two each 662D and 2532
19188	1356	Shuttle Race complete for 44-3 Machine, Nos. 648D, 2531, 2533, 5709, 19187 and two each 662D and 2532, use 24417
19404	1356	Shuttle Race complete for 44-13 Machine, Nos. 648D, 662D, 2419, 2533, 4621, 19402, 19403 and two 2532, use 24325
19490	—	Shuttle Race complete for 44-17 Machine, Nos. 648D, 662D, 2419, 2533, 4621, 19403, 19489 and two 2532, use 24327
24010	1357	Shuttle Race complete for 44-13 Machine, Nos. 648D, 2419, 2533, 62623 and two 2532, use 24325
24012	1357	Shuttle Race complete for 44-17 Machine, Nos. 648D, 2419, 2533, 24009, 24011 and two each 1053D and 2532, use 24327
24120	2006	Shuttle Race complete for 44-13 Machine, Nos. 907D, 2419, 2533, 24009, 24117, 24118, two 2532 and four 1053D, use 24325
24121	1358	Shuttle Race complete for 44-17 Machine, Nos. 907D, 2419, 2533, 24009, 24117, 24119, two 2532 and four 1053D, use 24327
24065	1342	Shuttle Race complete for 44-20 and 44-29 Machines, Nos. 648D, 2533, 24062 to 24064 and two each 1053D and 2532, use 24438
662D	782	Shuttle Race Cap Screw
647F	774	“ “ Screw, use 145D
240D	782	“ “ Slide Spring Screw for 12432
2526	5842	“ “ Tension Spring for 12417, use 15098
24066	1340	Slack Thread Regulator for 44-20 and 44-29 Machines, use 20060

27636

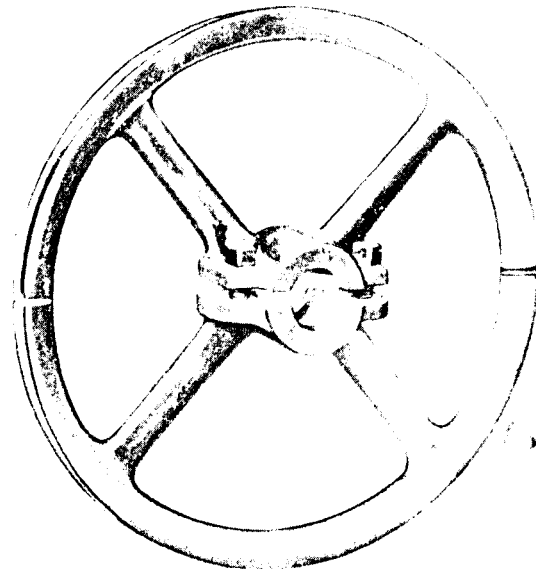
27474



2878



27070



INSTRUCTIONS

FOR

PARTS

PLATE 766—ONE-FOURTH SIZE

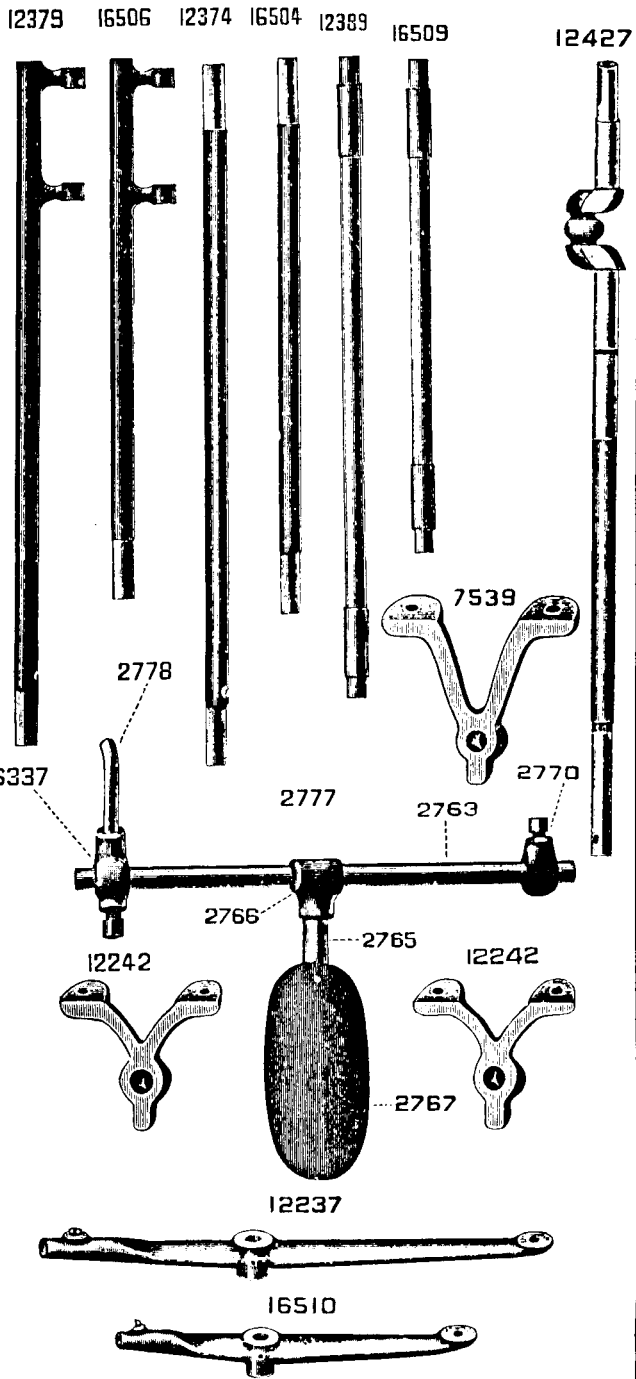


PLATE 767—ONE-HALF SIZE

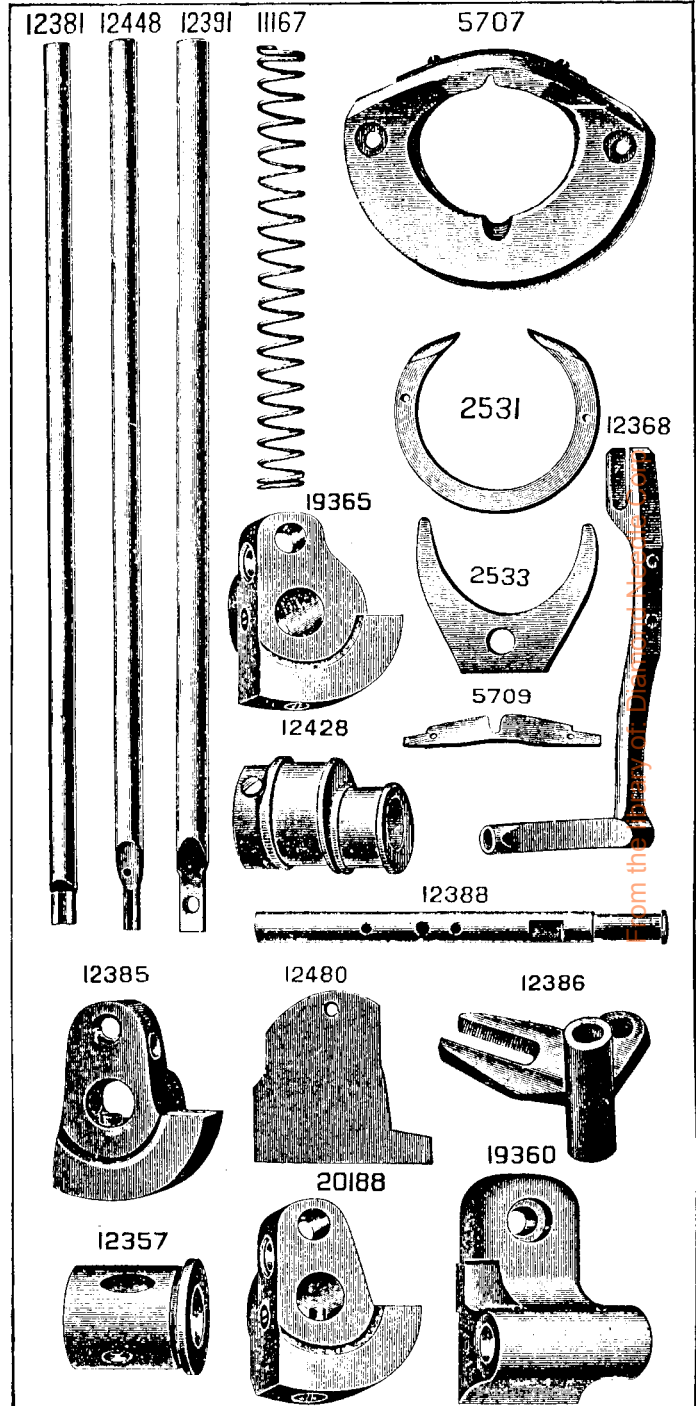


PLATE 768—ONE-HALF SIZE

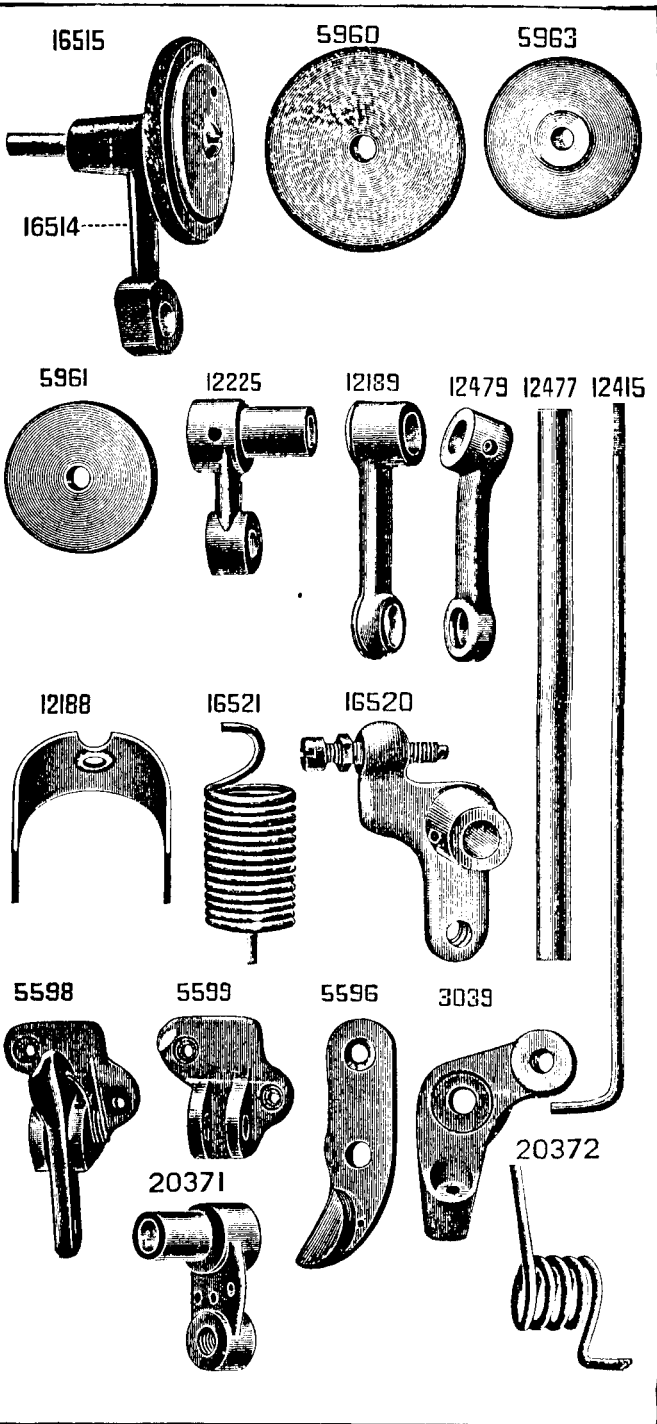
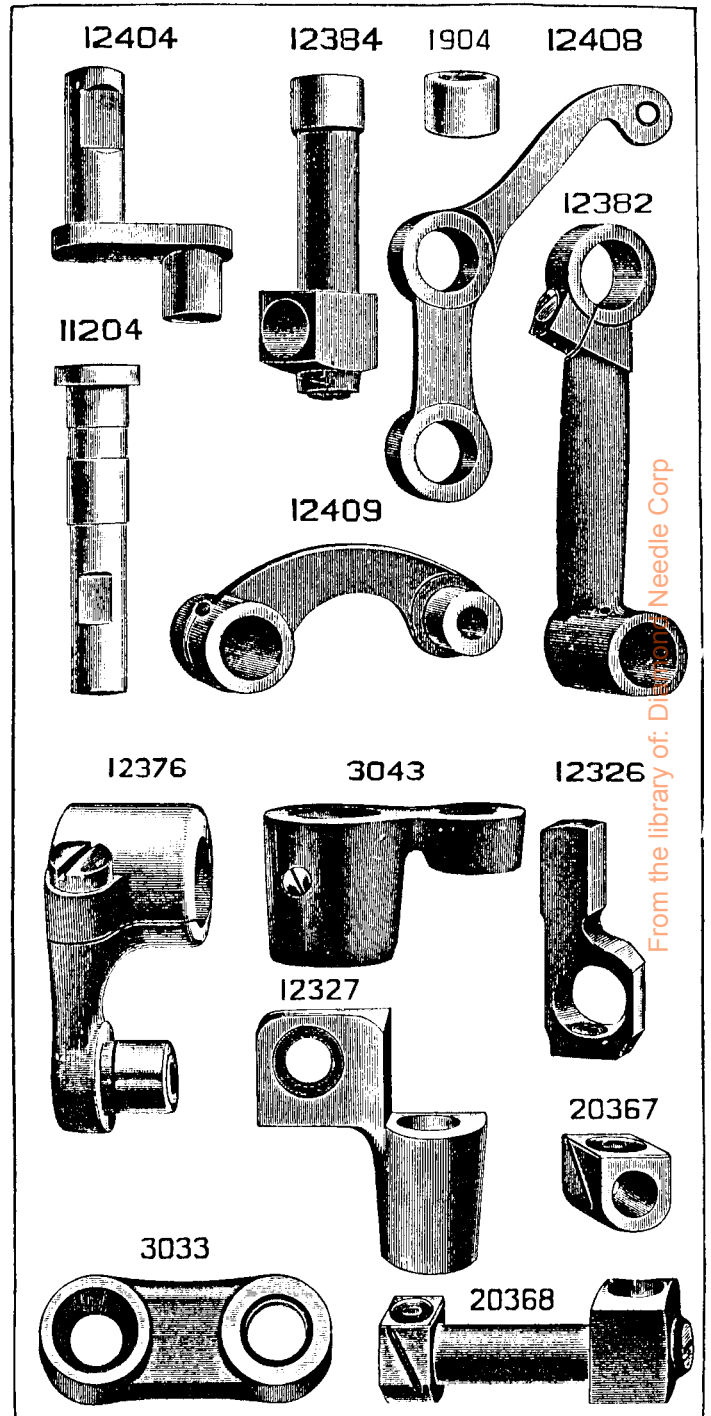


PLATE 770—FULL SIZE



From the library of: DePue Needle Corp

PLATE 771—FULL SIZE

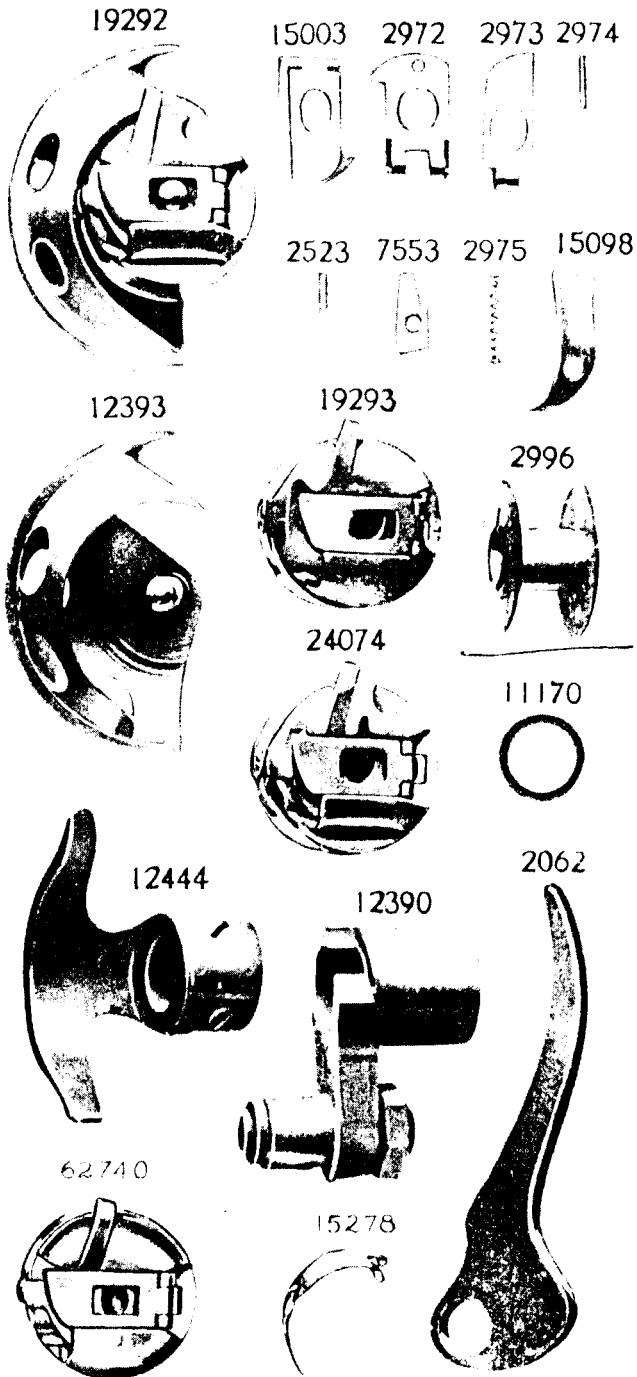
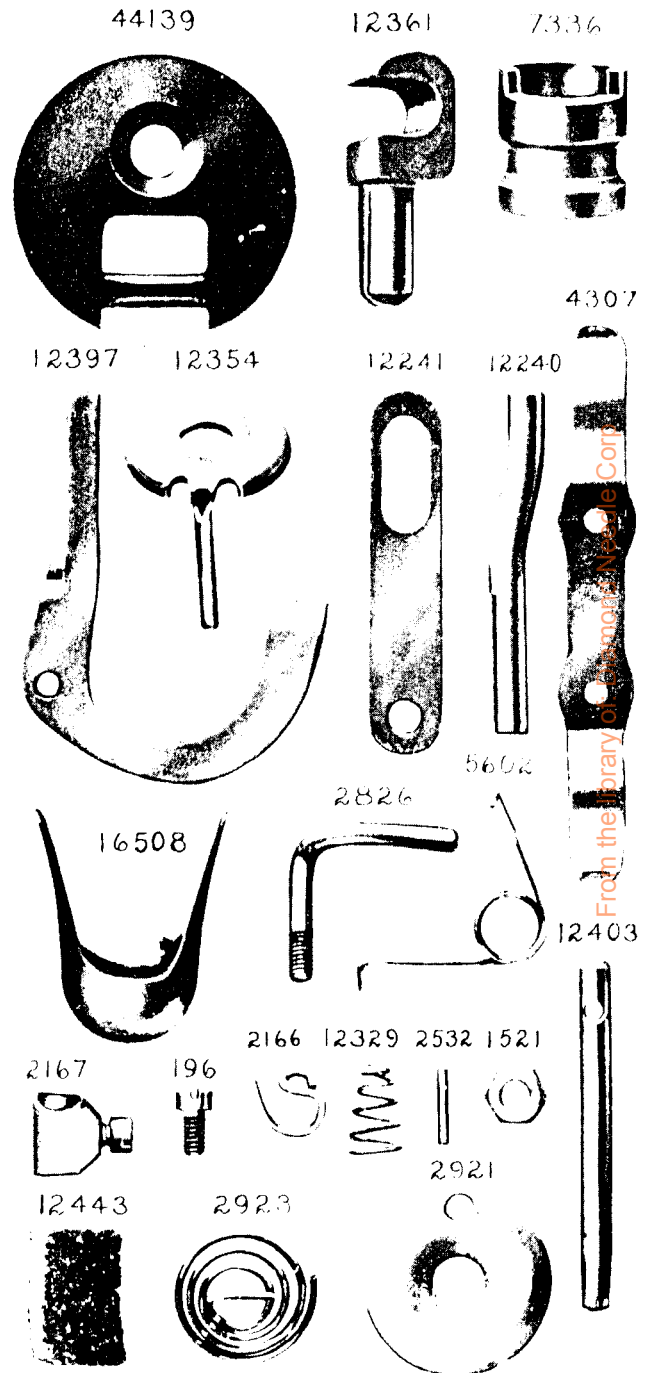


PLATE 772—FULL SIZE



From the library of the Smithsonian Institution

PLATE 773—FULL SIZE

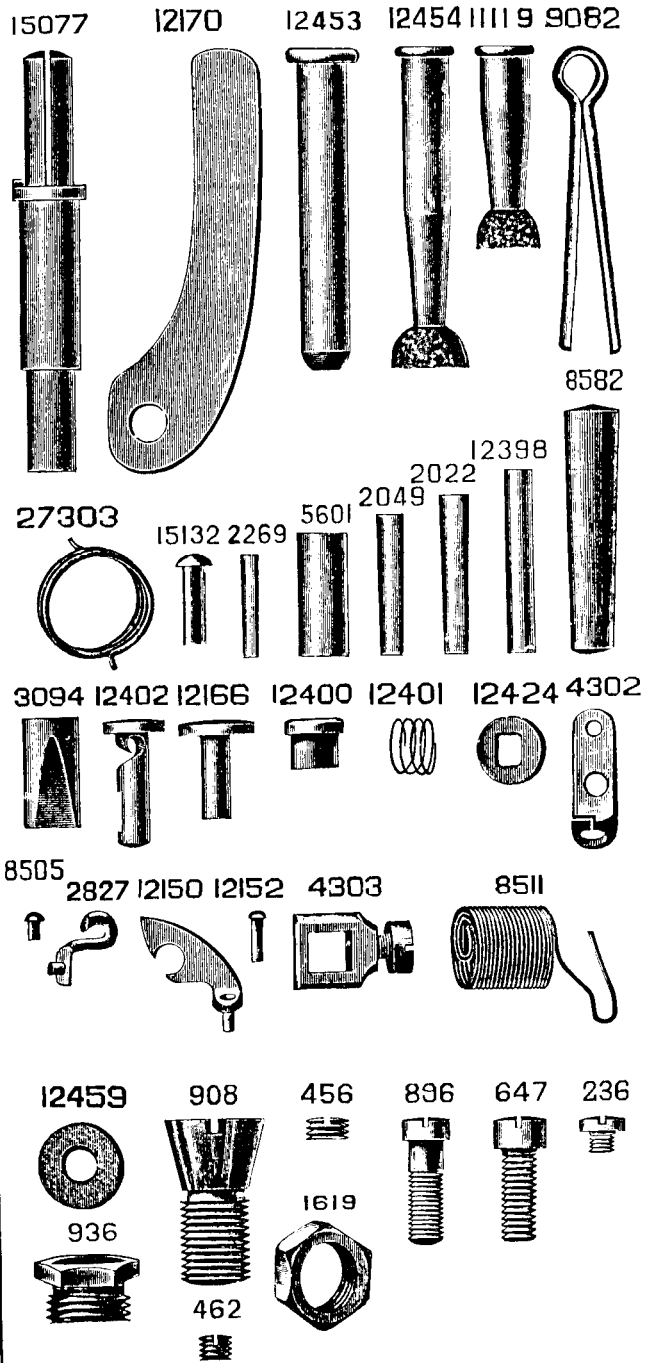
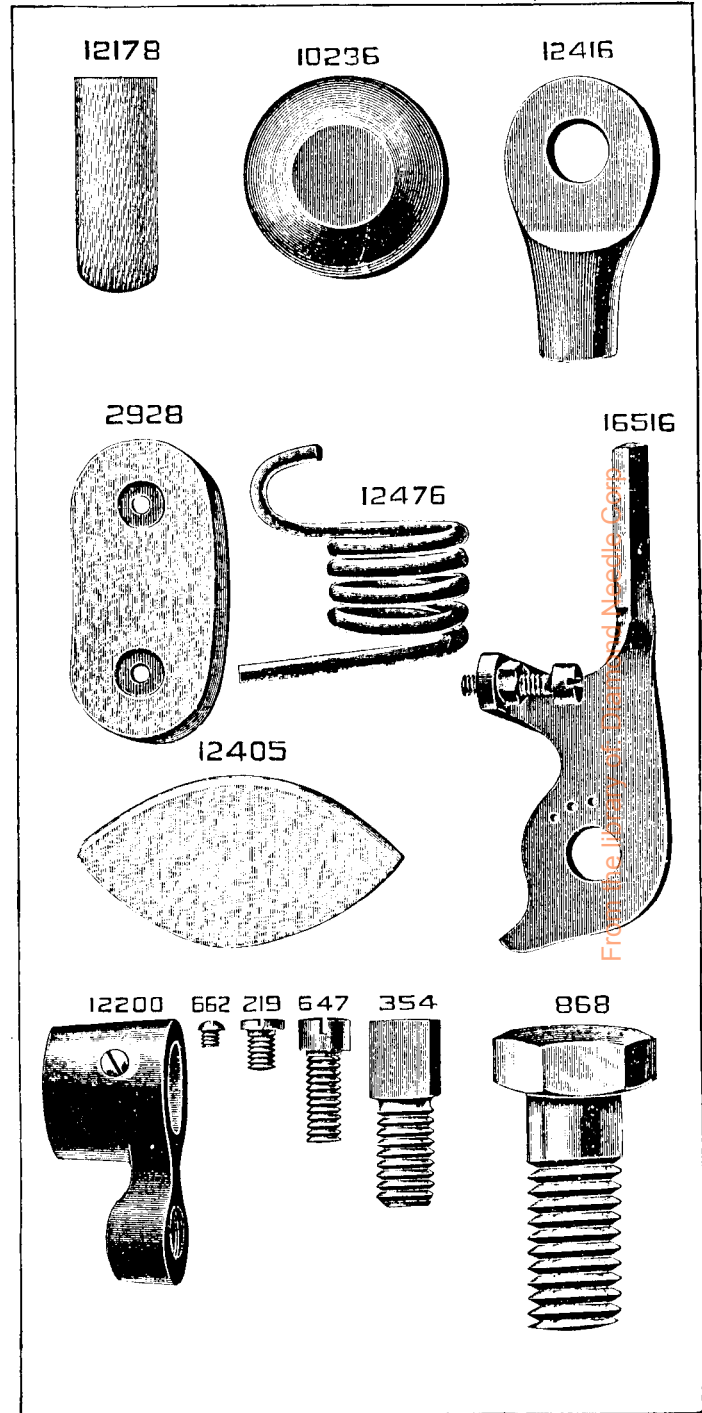


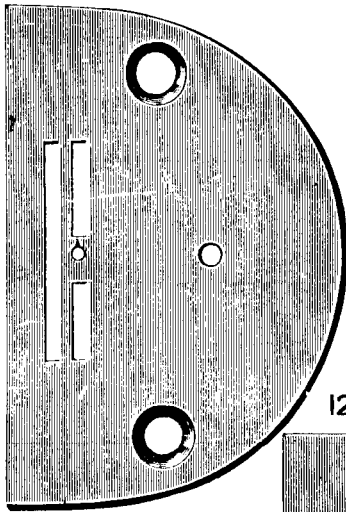
PLATE 774—FULL SIZE



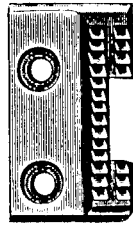
From the Library of the University of Illinois at Urbana-Champaign

PLATE 775—FULL SIZE

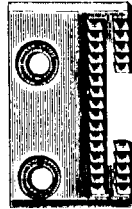
12473



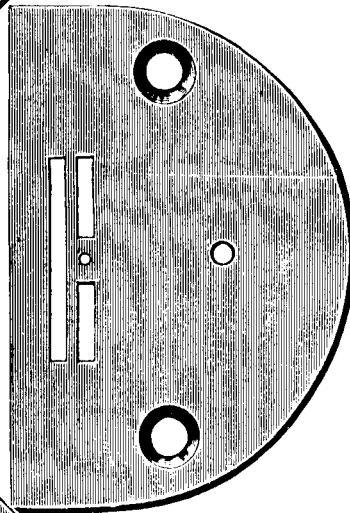
12471



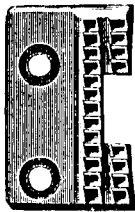
20369



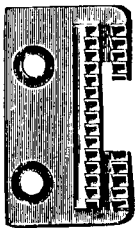
12434



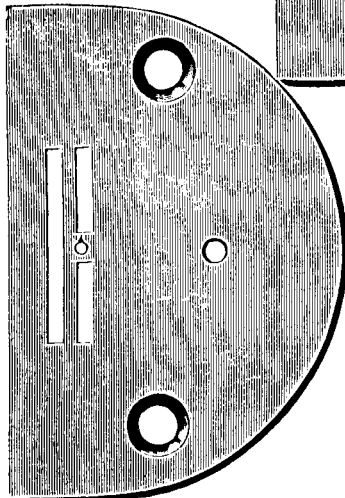
12433



19488



12461



12460

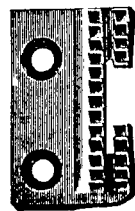
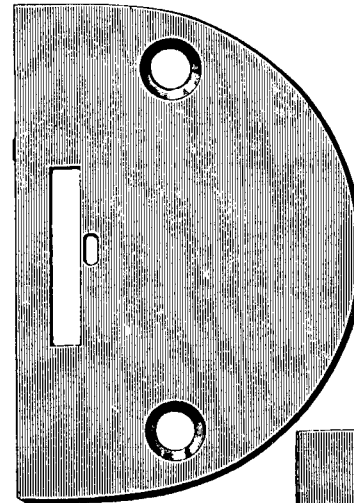
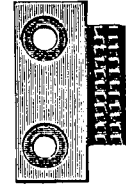


PLATE 776—FULL SIZE

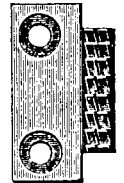
12438



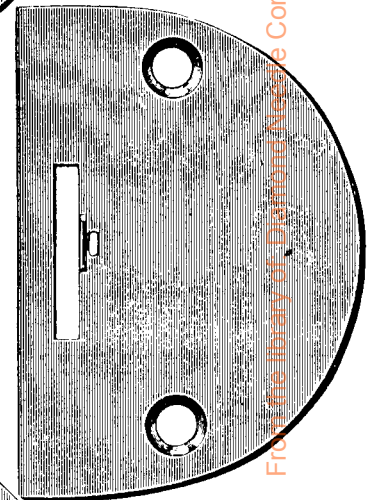
12436



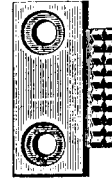
20323



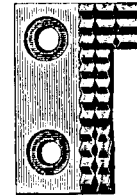
12452



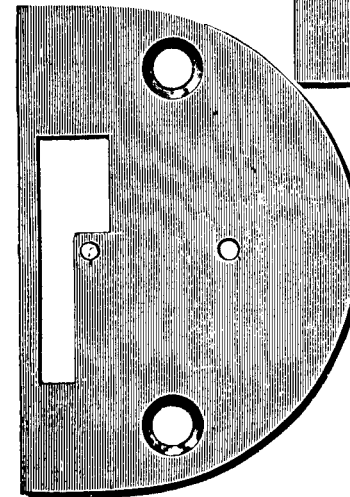
20329



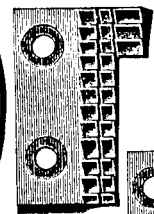
20303



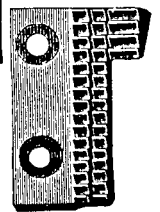
12411



12369



12457



From the library of Diamond Missile Corp

PLATE 777—FULL SIZE

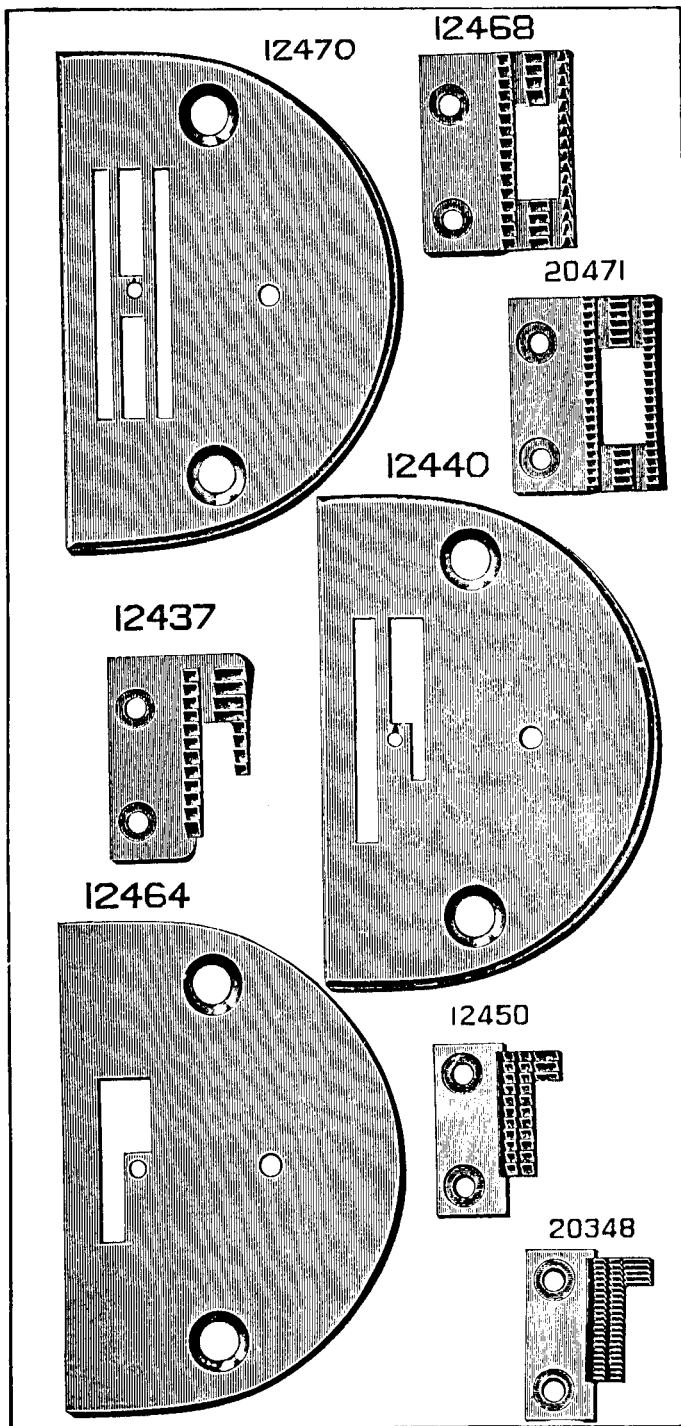
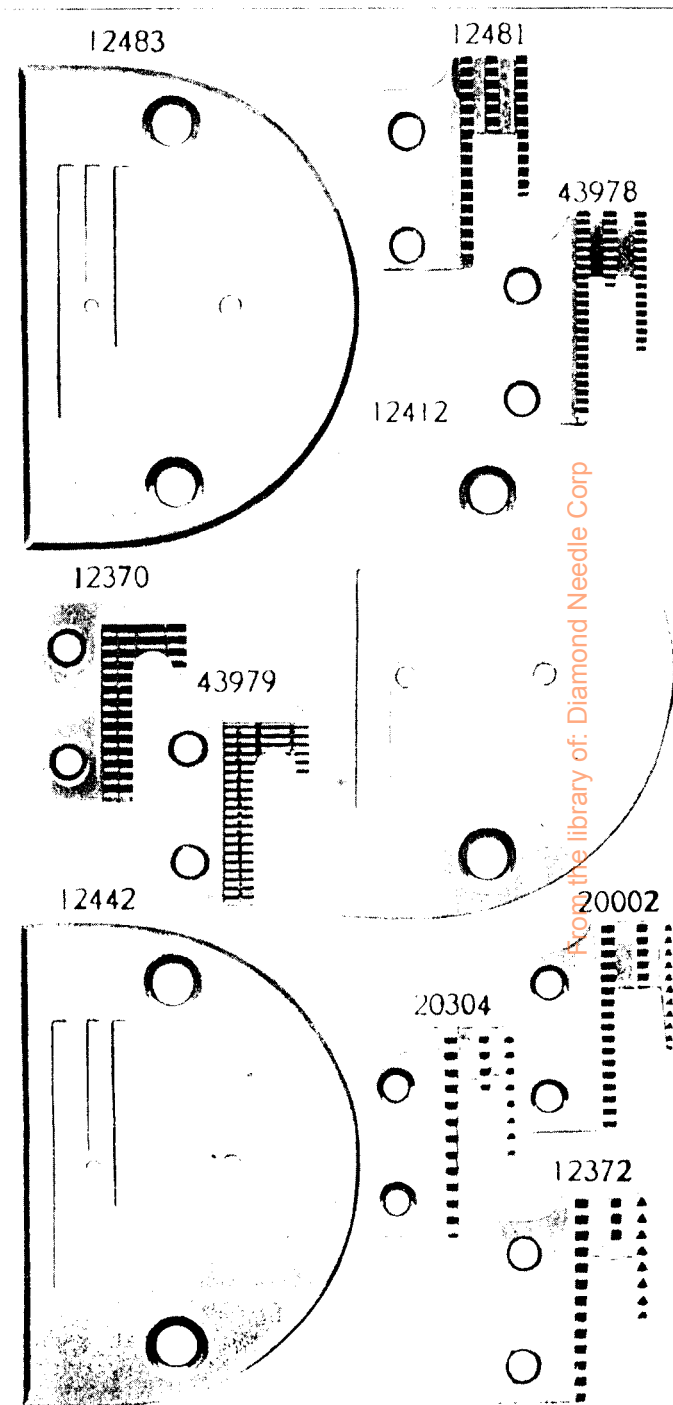


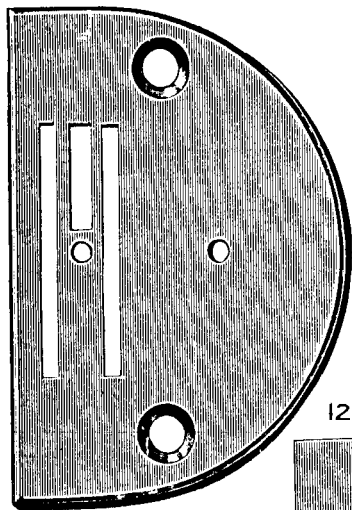
PLATE 778—FULL SIZE



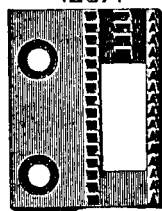
From the library of: Diamond Needle Corp

PLATE 779—FULL SIZE

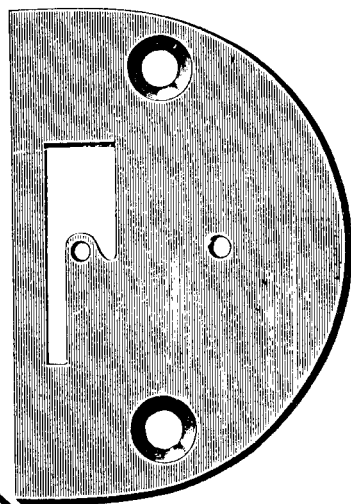
12413



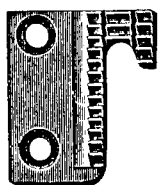
12371



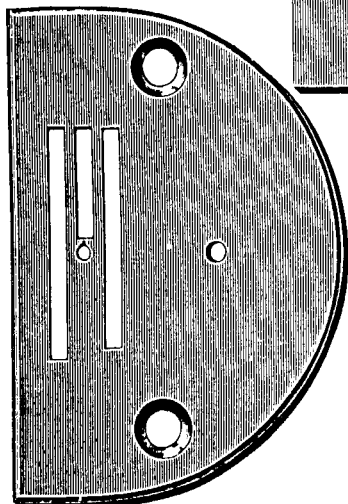
12426



12425



12456



12455

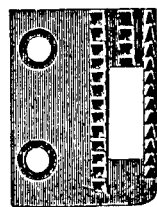
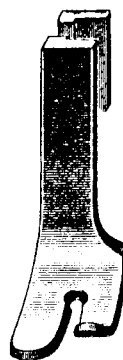


PLATE 780—FULL SIZE

12142



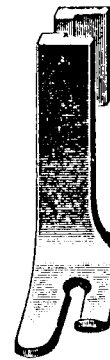
12143



12144



12259



12260



12435



20038



20458



24546



43925



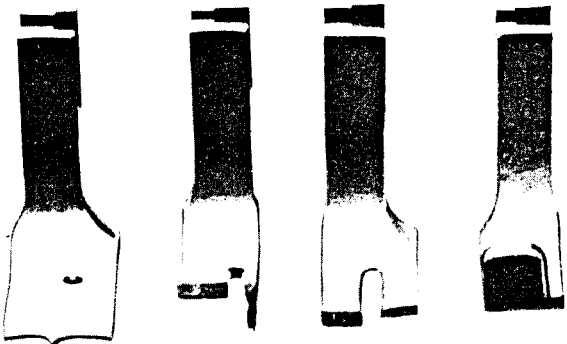
20157



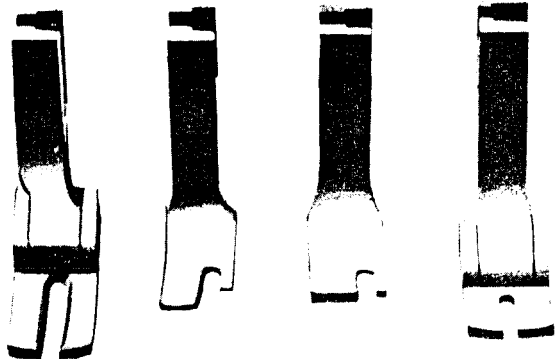
From the Library of: Diamond Needle Corp

PLATE 781—FULL SIZE

12406 12463 12462 12467



20311 20342 20343 20346



20361 20359 20328 24983

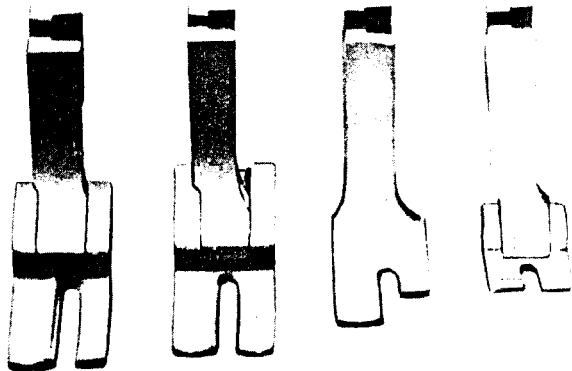
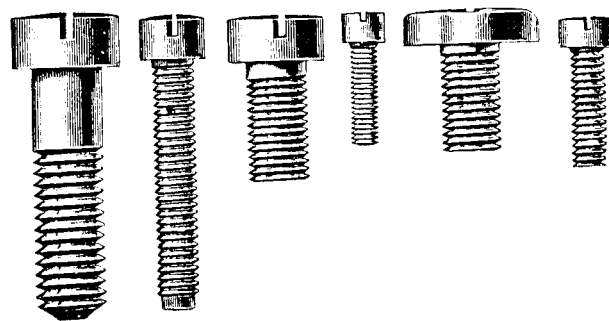
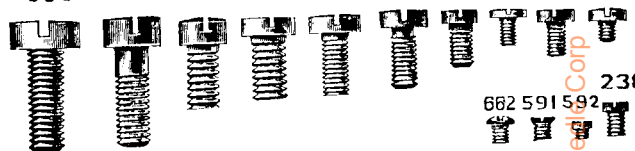


PLATE 782—FULL SIZE

748 803 130 152 144 145

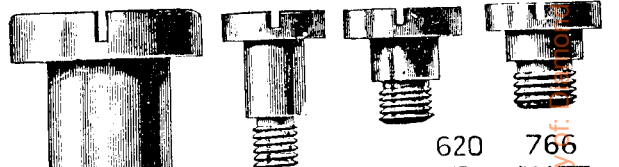


690 157 178 180 190 808 208 229 233 240



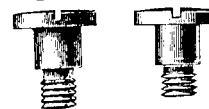
662 591 592 238

693 32 58 65

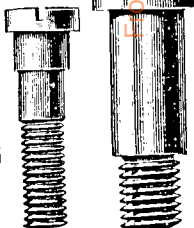


620 766

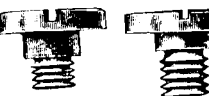
648 907



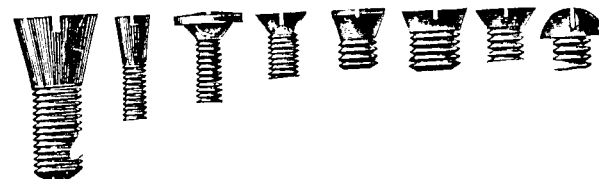
689 802



76 75



375 794 775 691 696 860 397 333



Needle Corp

PLATE 783—FULL SIZE

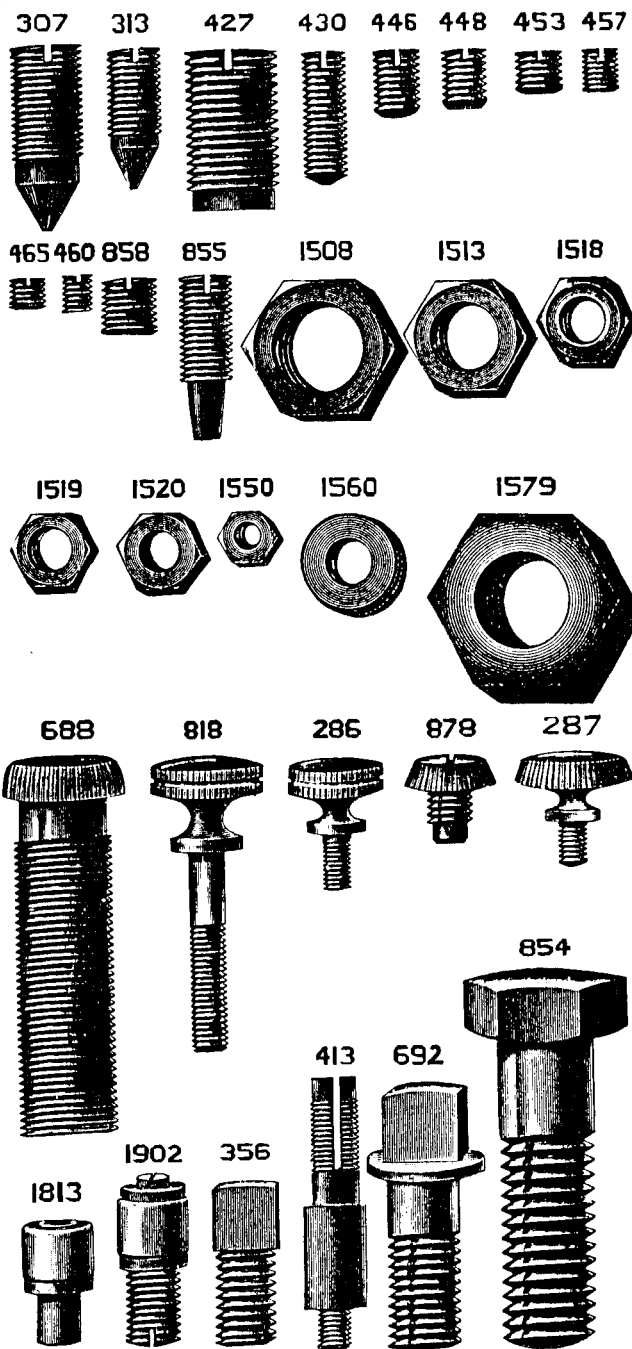


PLATE 932—FULL SIZE

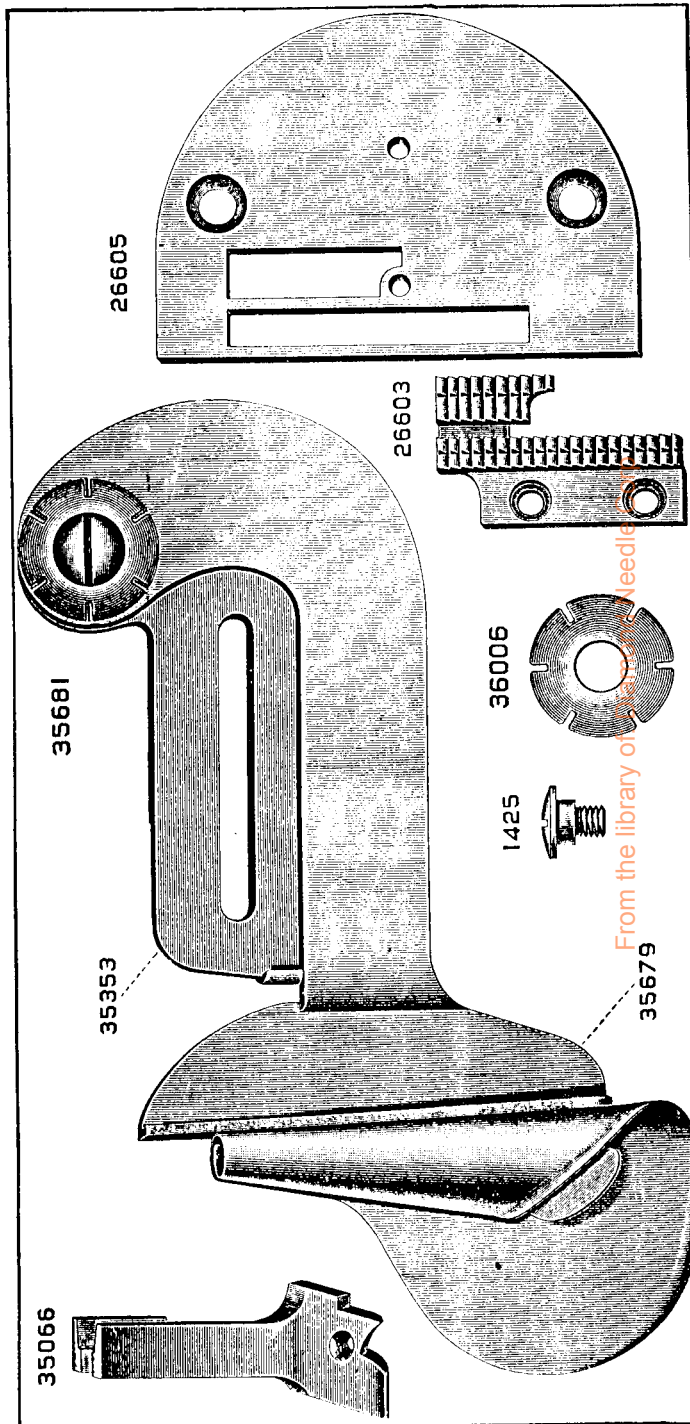
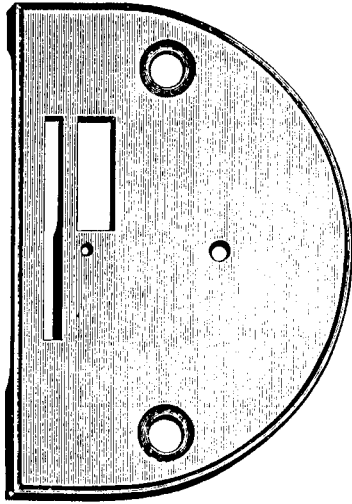
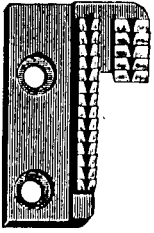


PLATE 946—FULL SIZE

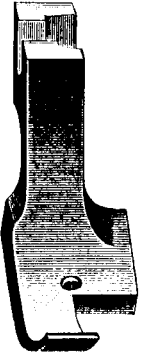
PLATE 953—ONE-HALF SIZE

19474

19475

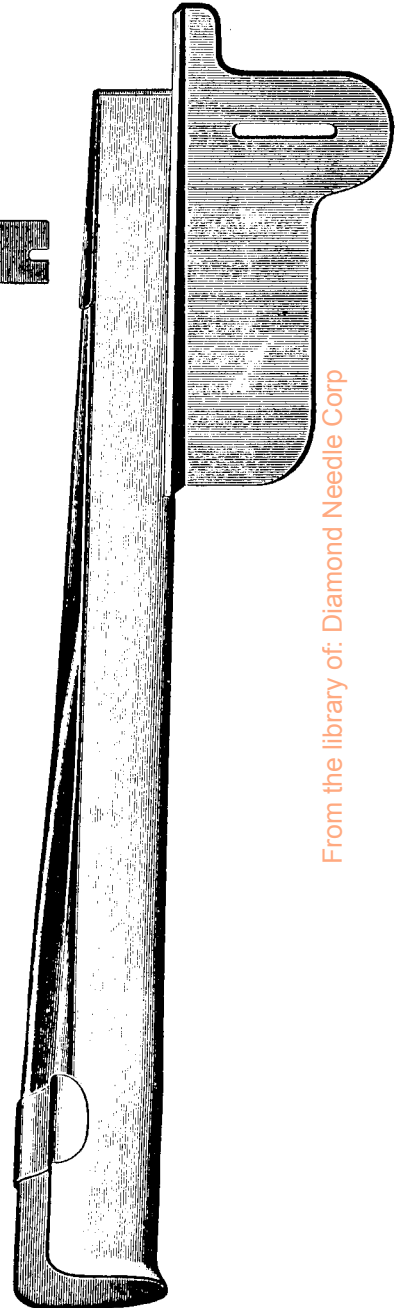
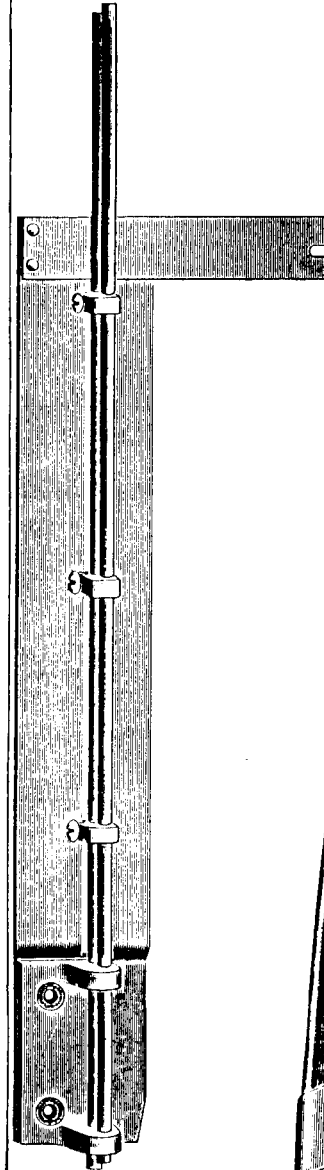


35350



26755

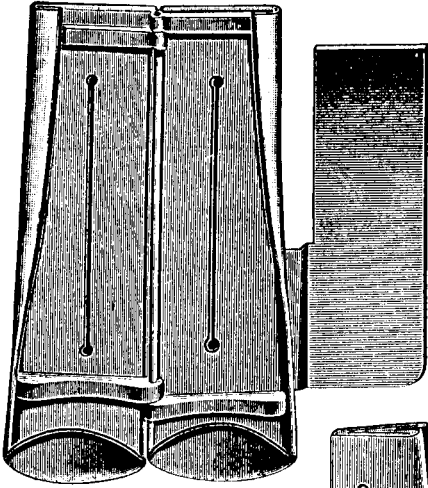
35345



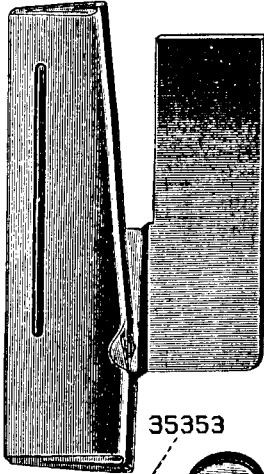
From the library of: Diamond Needle Corp

PLATE 970—ONE-HALF SIZE

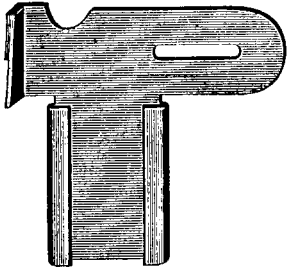
35347



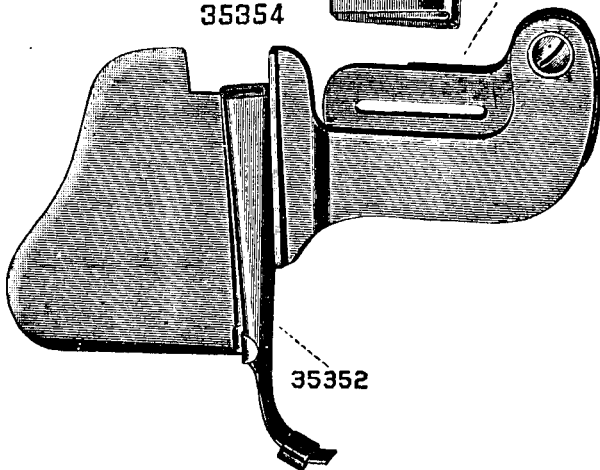
35348



35349



35354

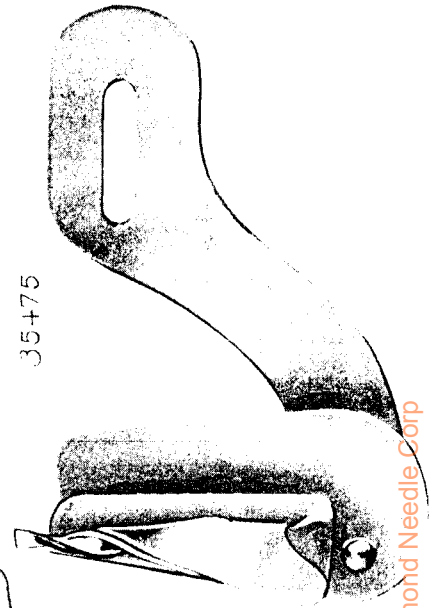


35352

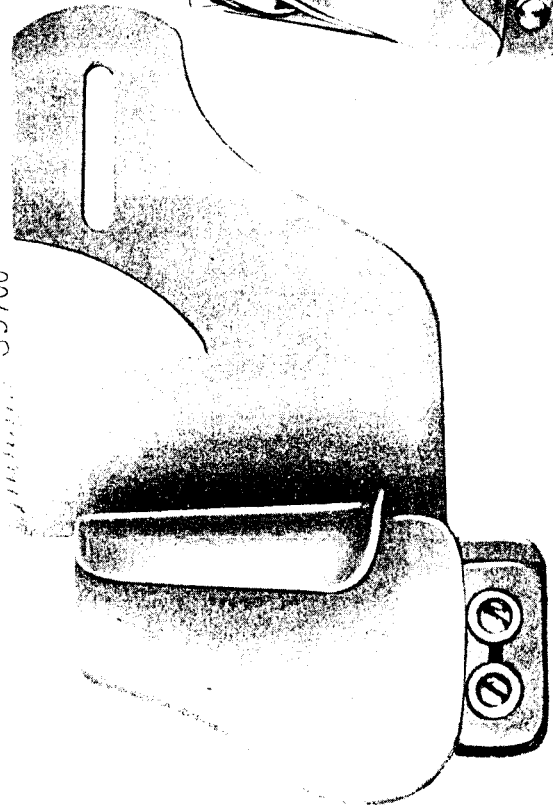
35353

PLATE 976—FULL SIZE

35475



35700



From the library of: Diamond Needle Corp

PLATE 984—FULL SIZE

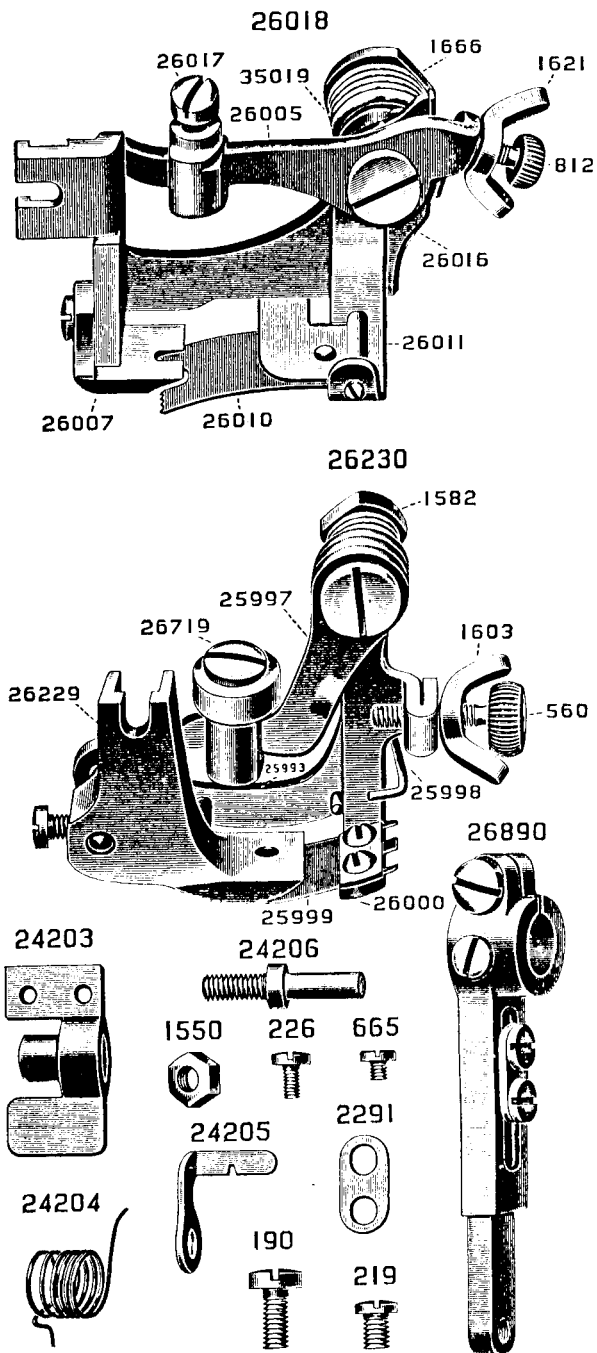
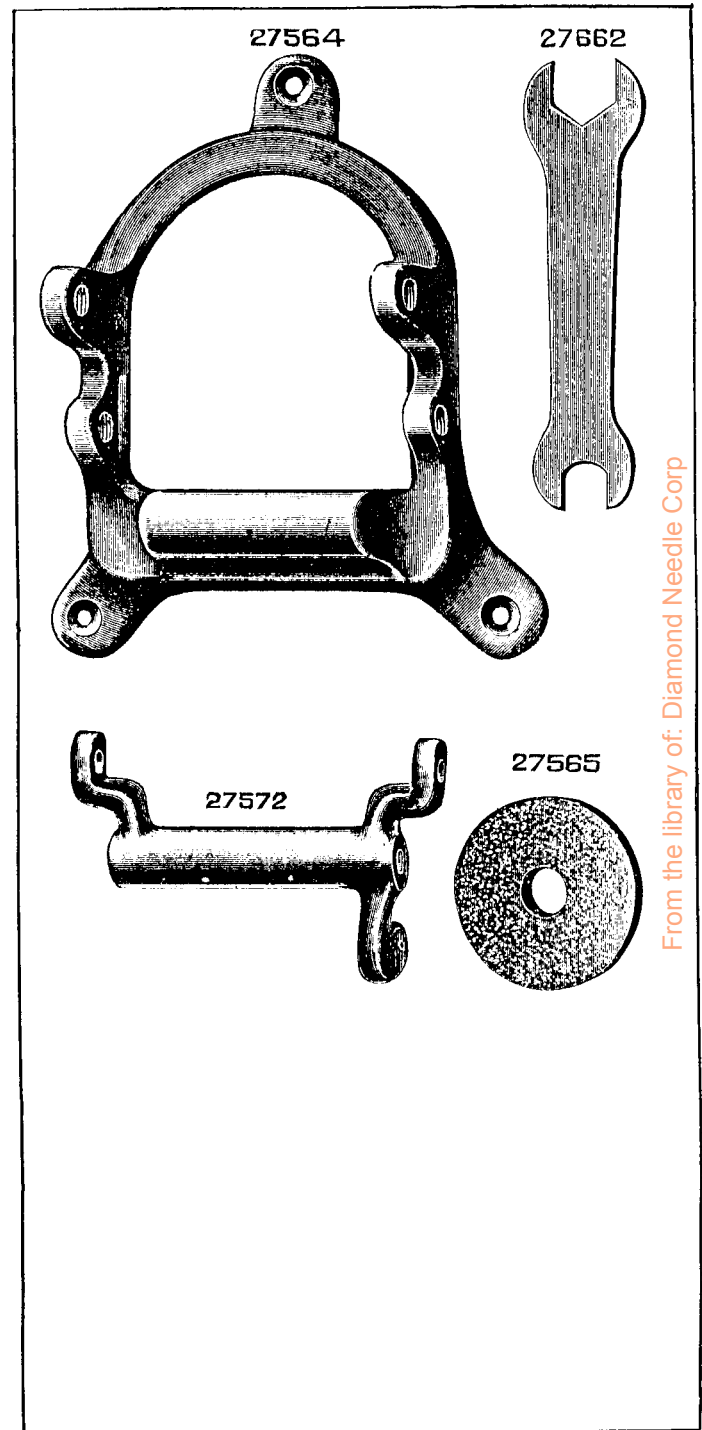


PLATE 1104—ONE-HALF SIZE



From the library of: Diamond Needle Corp

PLATE 1105—FULL SIZE

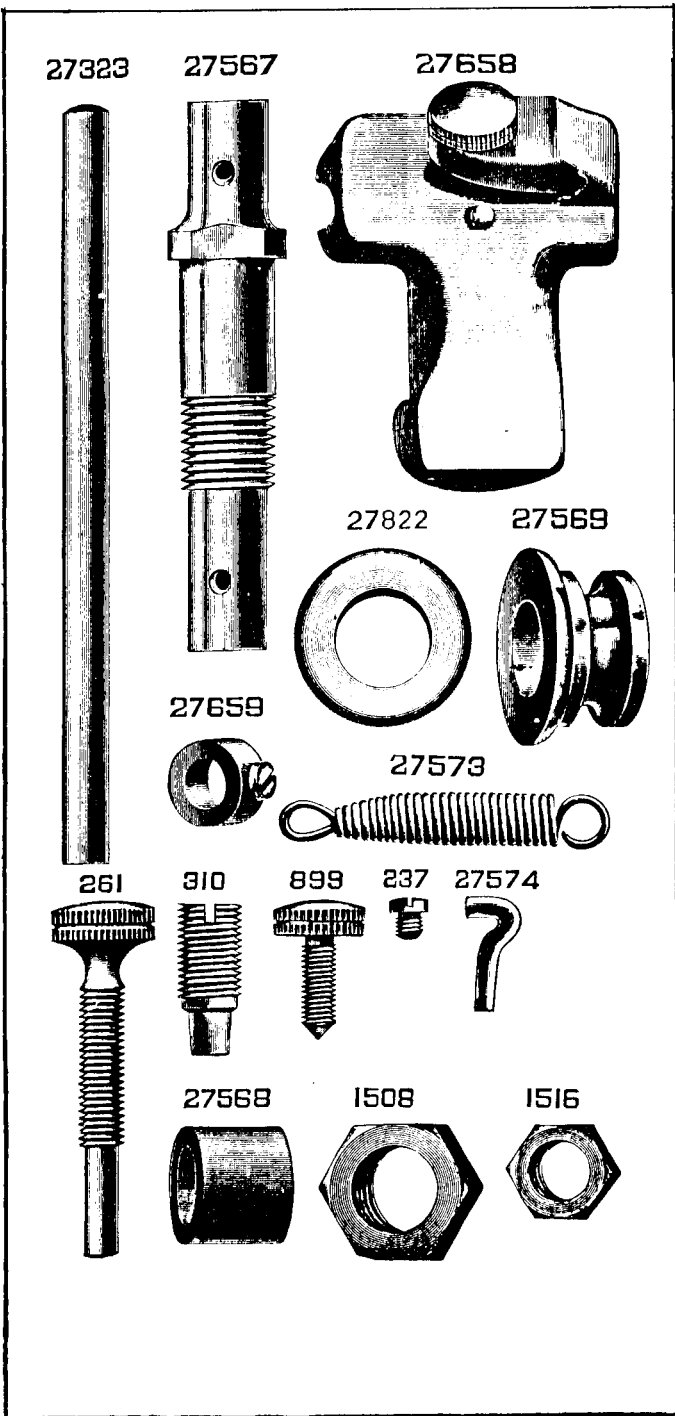


PLATE 1162—ONE-HALF SIZE

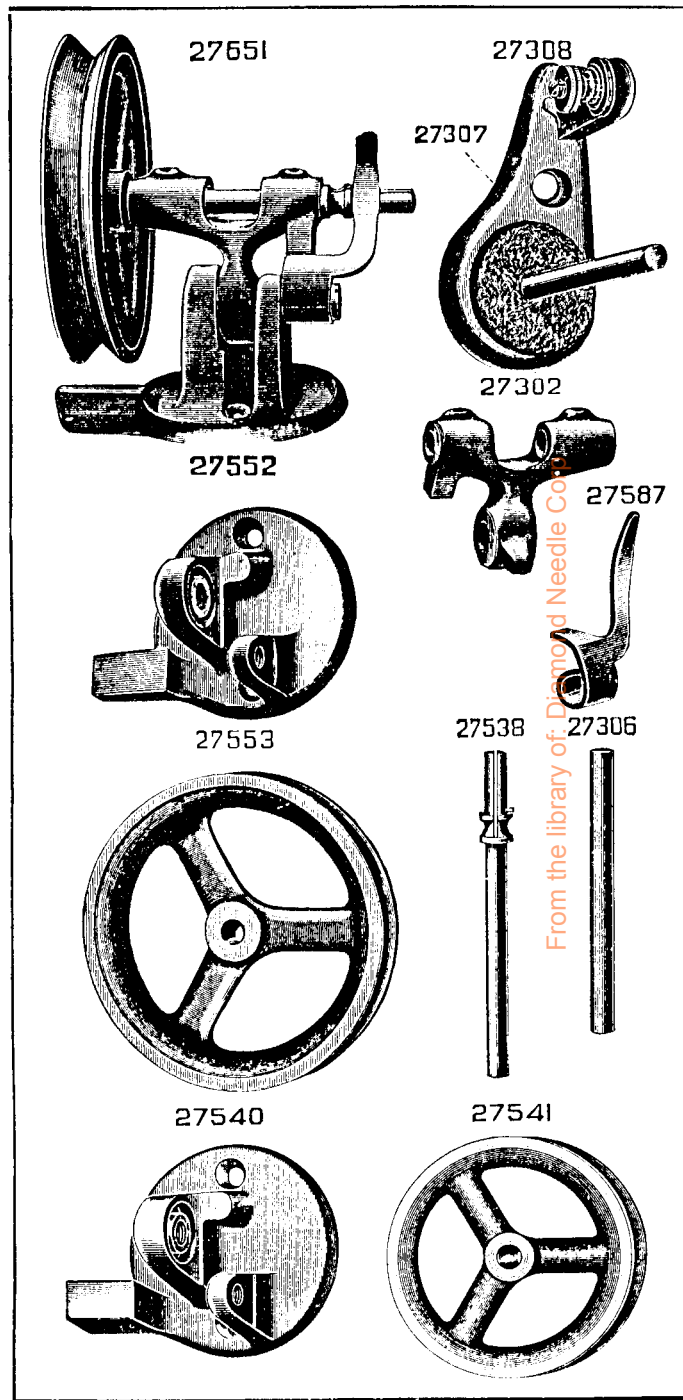


PLATE 1206—FULL SIZE

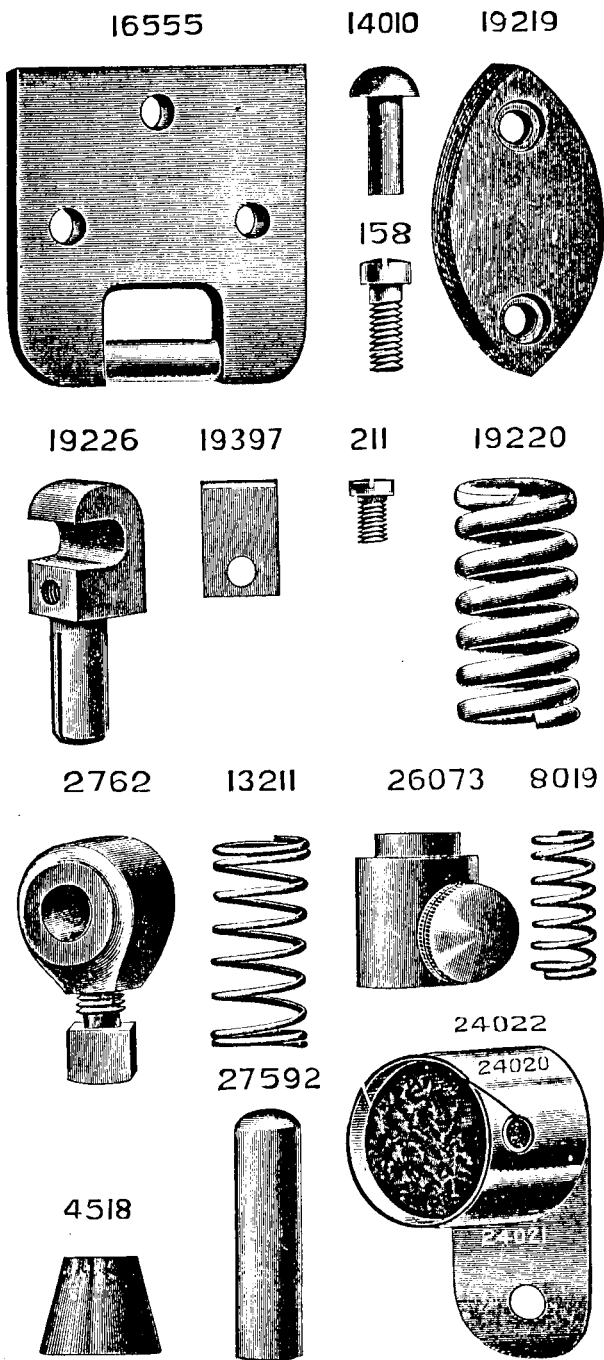


PLATE 1230—ONE-FOURTH SIZE

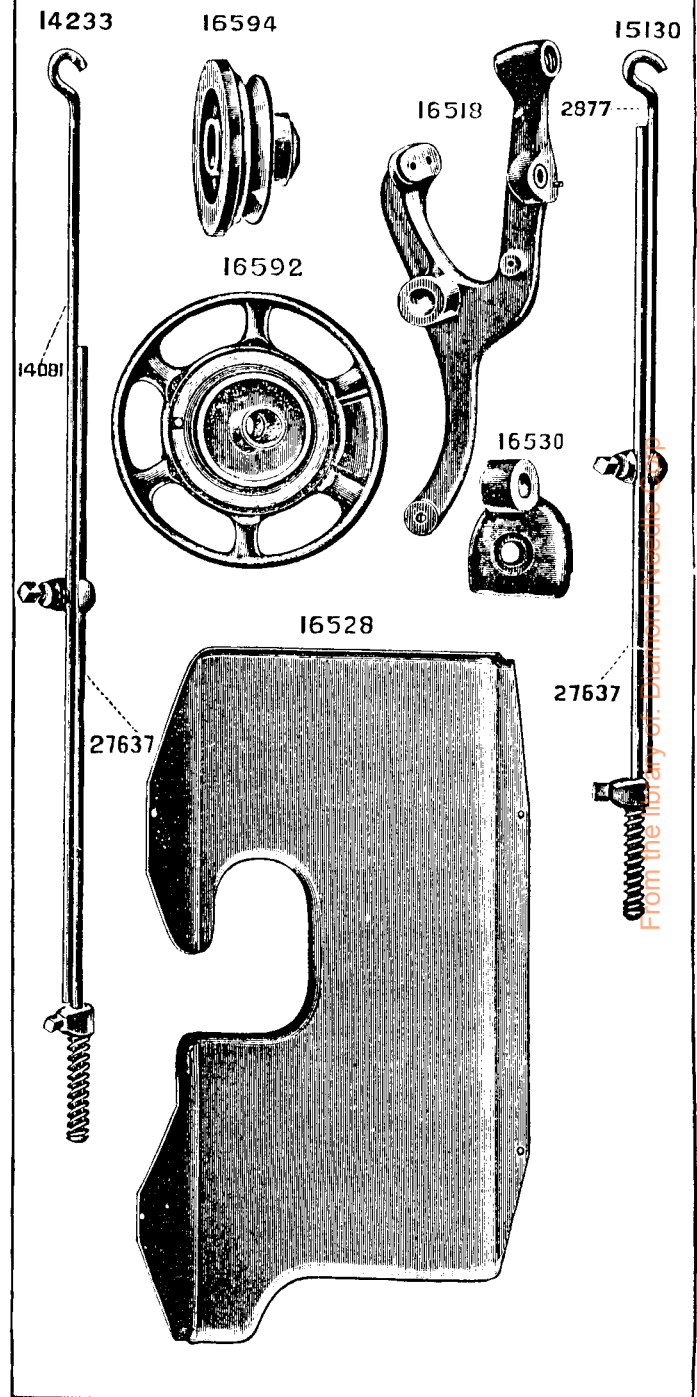


PLATE 1231—ONE-FOURTH SIZE

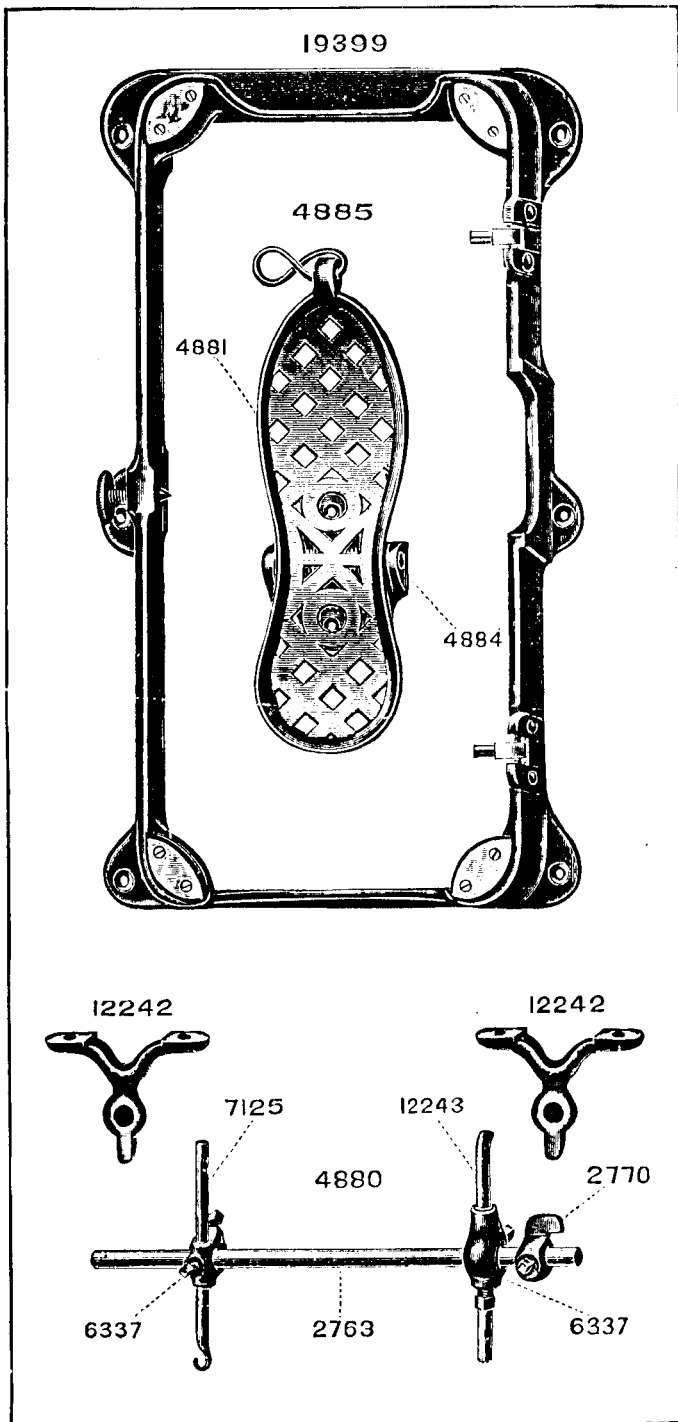
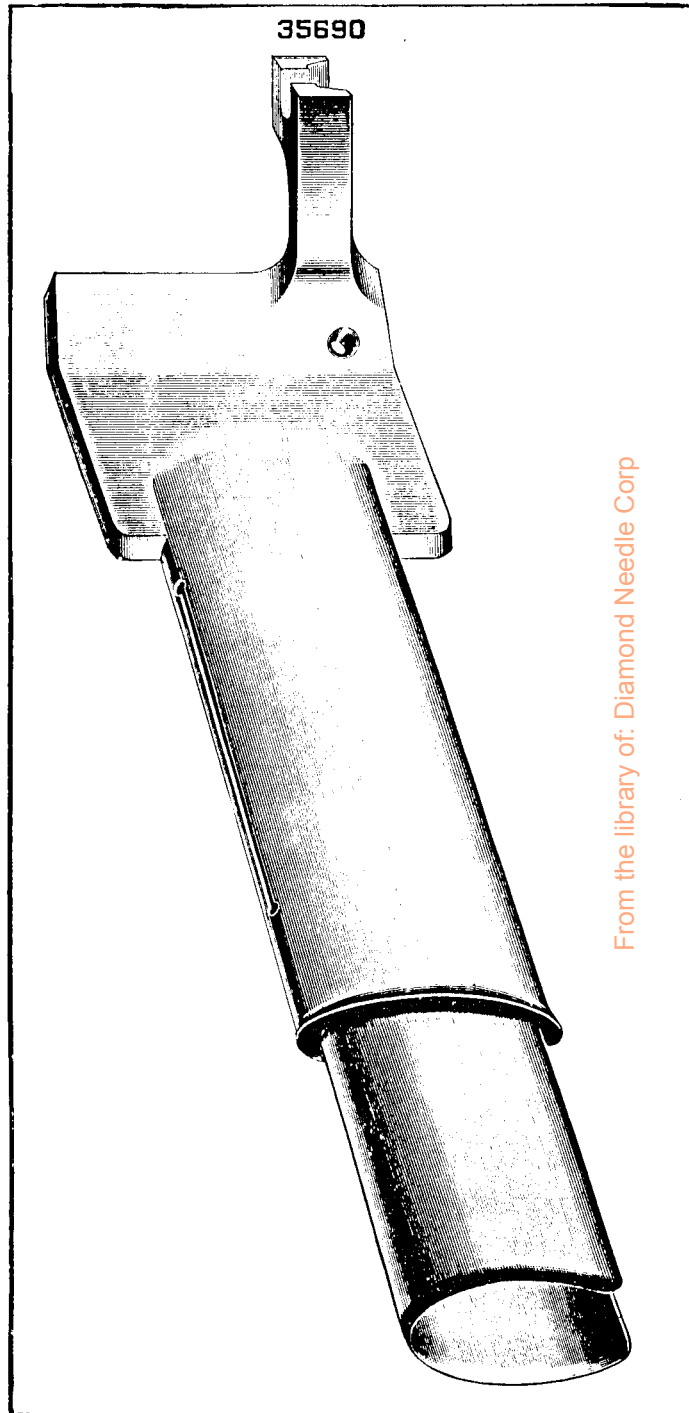
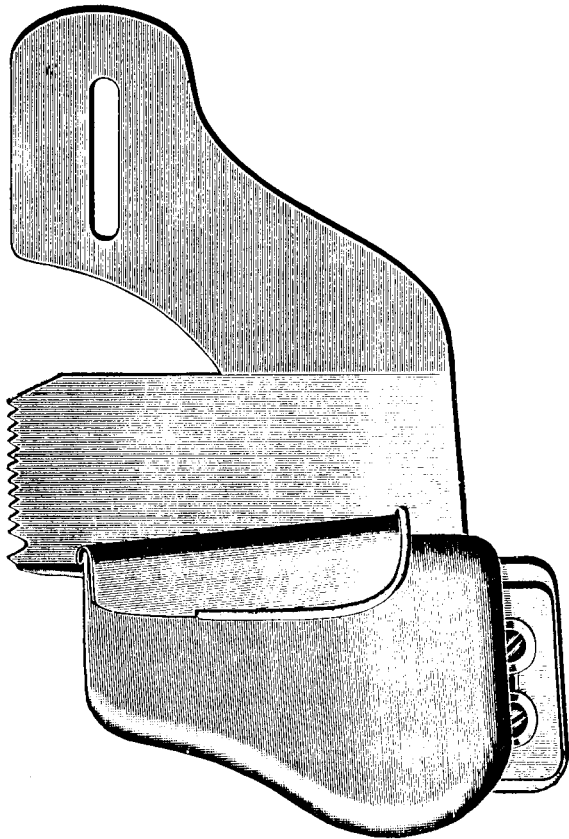


PLATE 1246—FULL SIZE

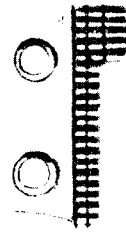


From the library of: Diamond Needle Corp

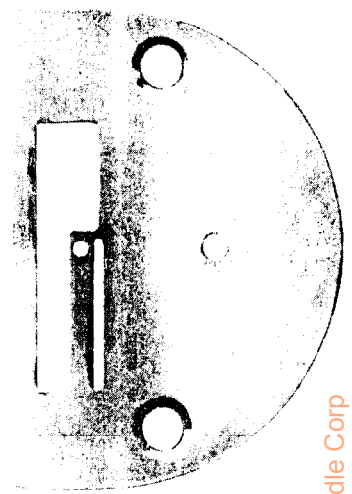
35700



35711



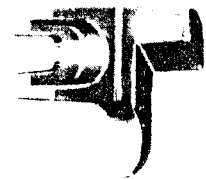
35712



35713



35211



35231



35163

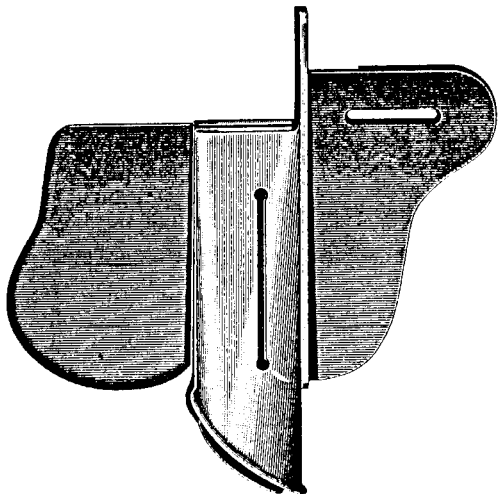


35201



PLATE 1253—ONE-HALF SIZE

35716



35855

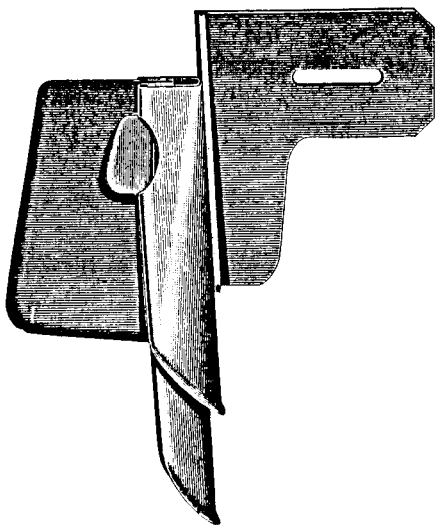
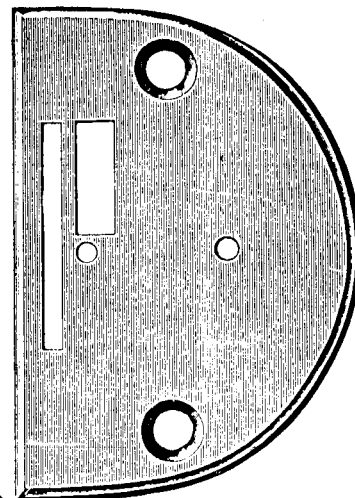
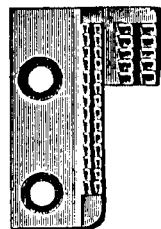


PLATE 1258—FULL SIZE

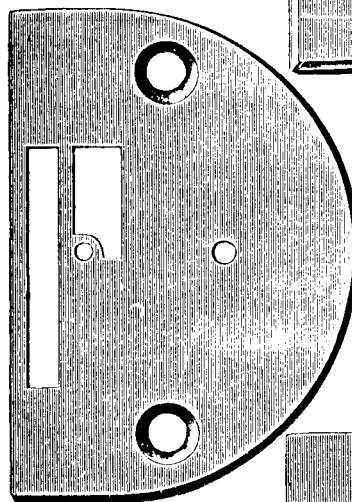
19475



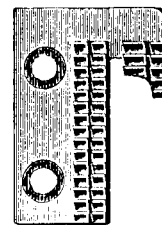
19474



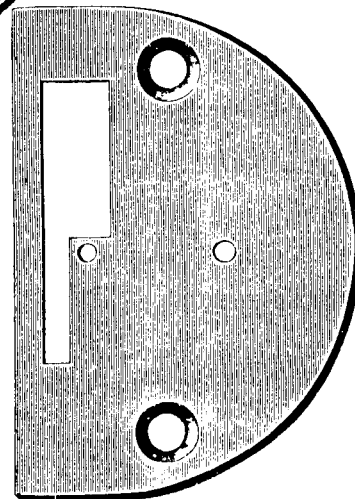
20010



20009



20019



20018

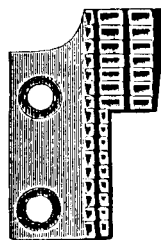


PLATE 1259--FULL SIZE

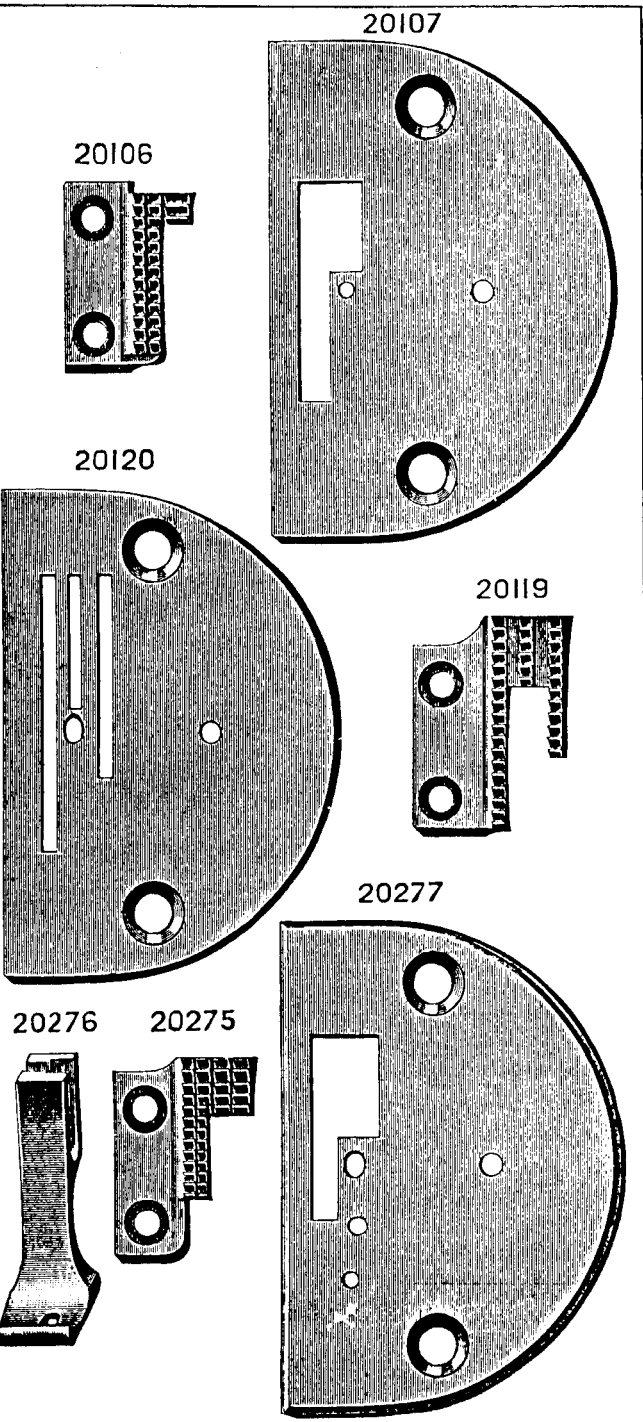


PLATE 1260--FULL SIZE

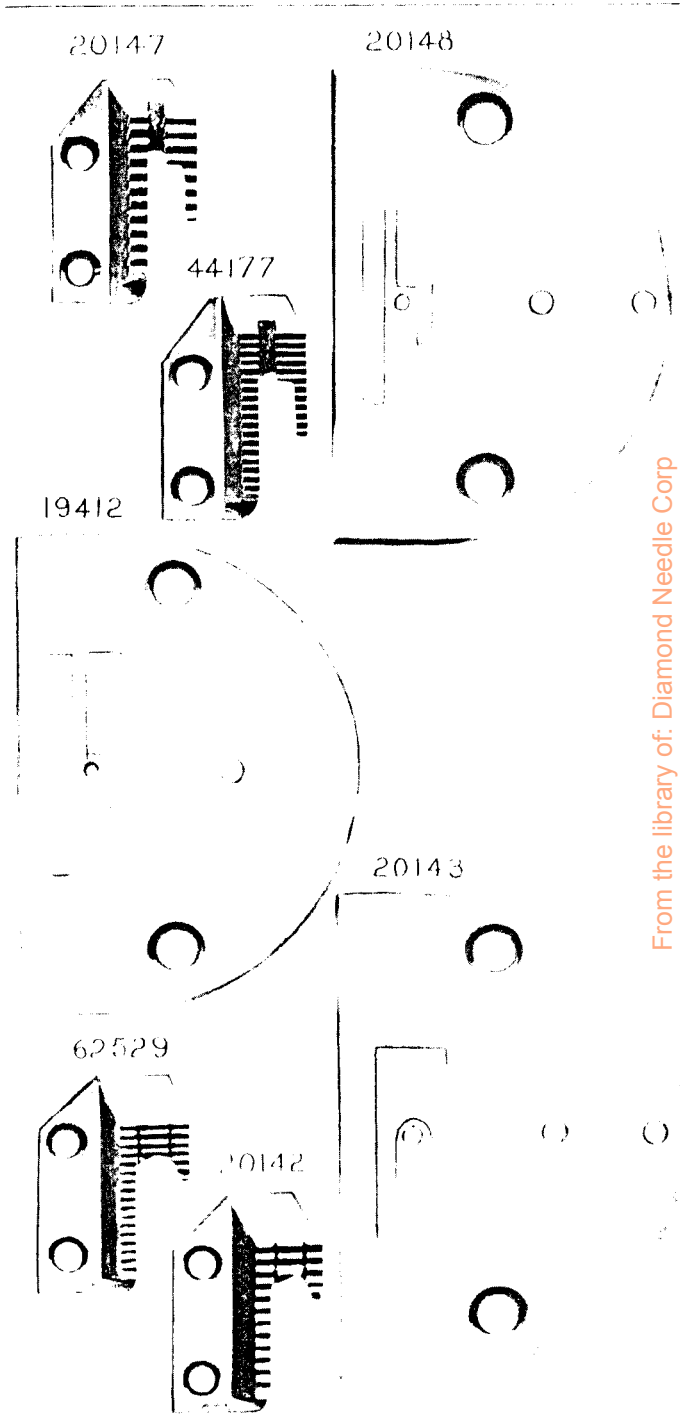
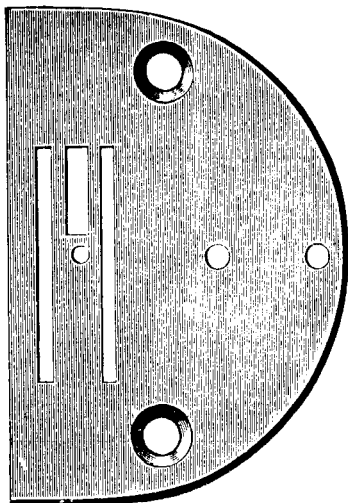
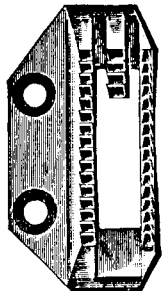


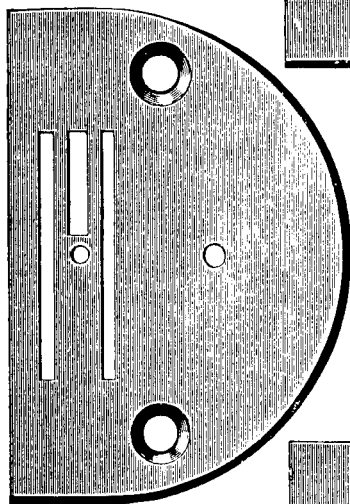
PLATE 1261—FULL SIZE

20124

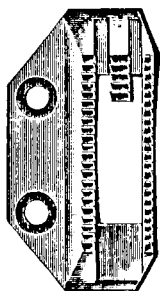
20117



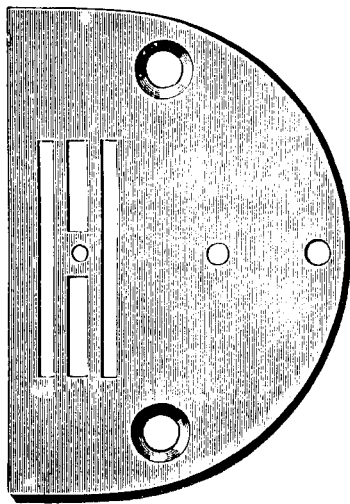
19497



20132



20160



20159

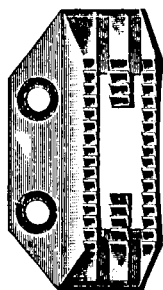
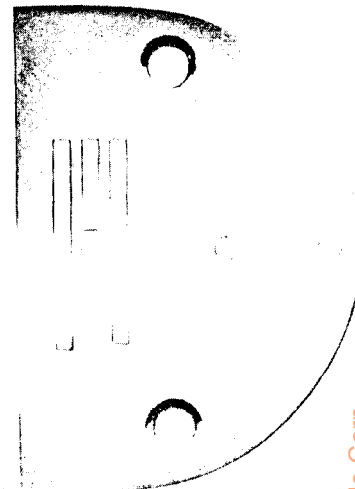
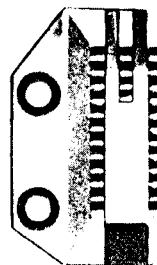


PLATE 1262—FULL SIZE

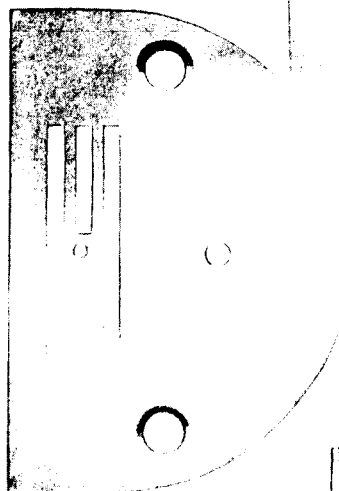
20157



20151



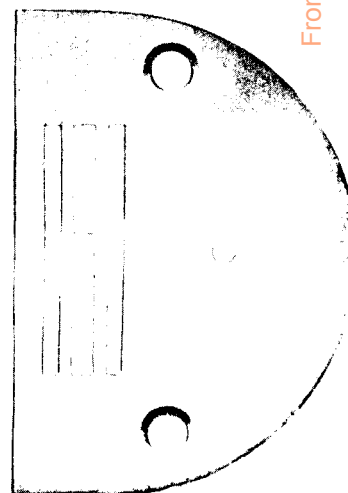
19415



44144



19418



44156



20158



From the library of: Diamond Needle Corp

PLATE 1263—FULL SIZE

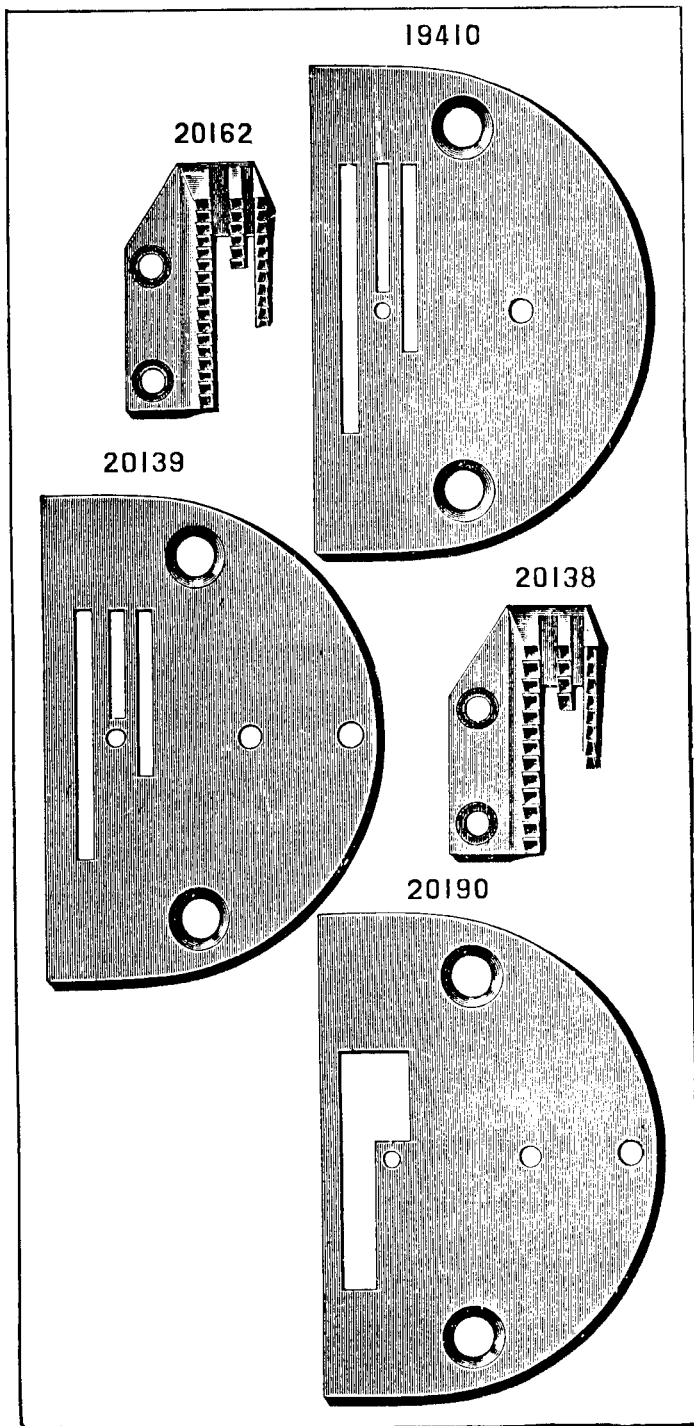
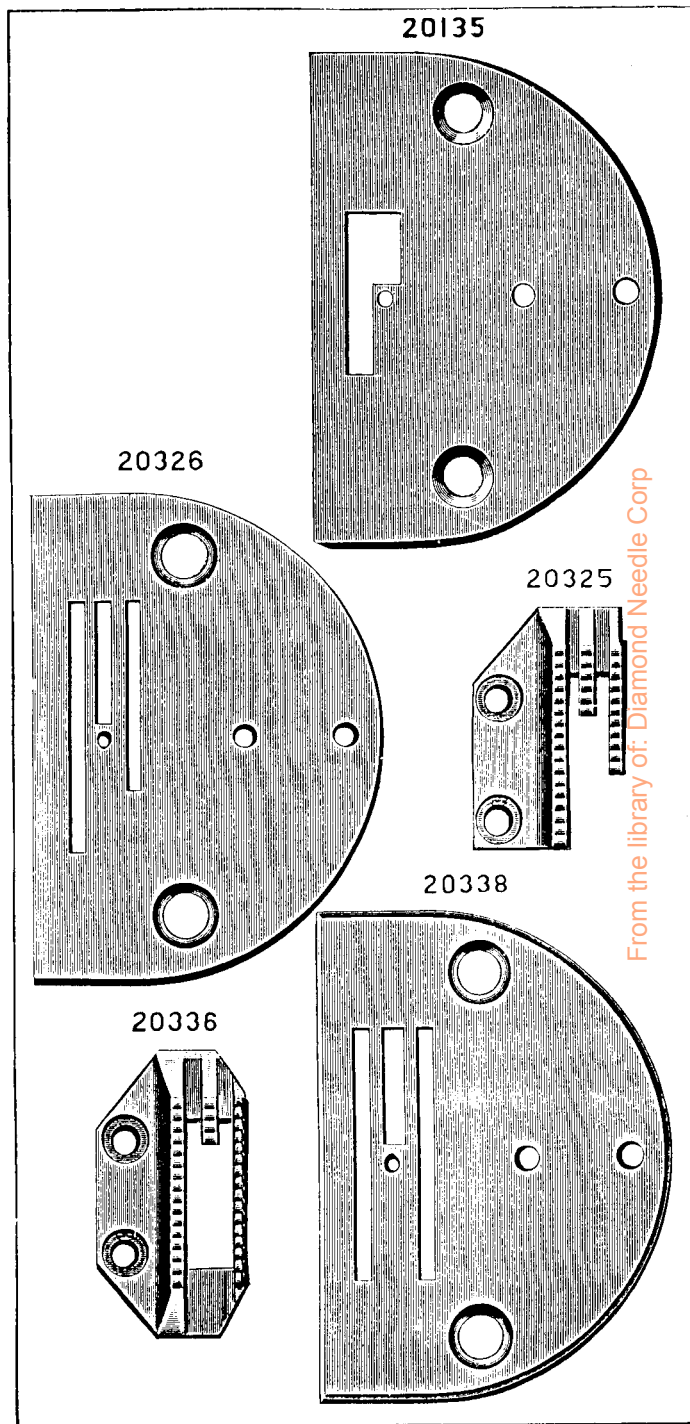


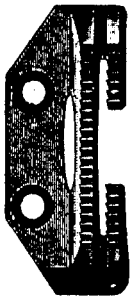
PLATE 1264—FULL SIZE



From the library of: Diamond Needle Corp

PLATE 1266—FULL SIZE

20137



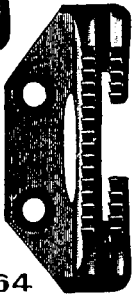
20154



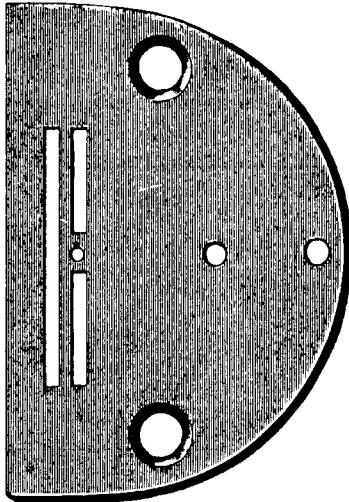
2080



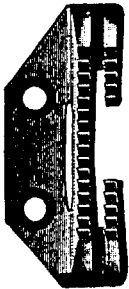
20116



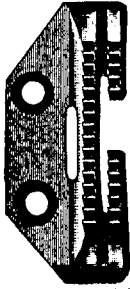
20123



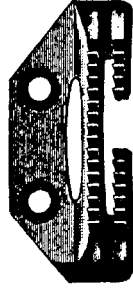
20164



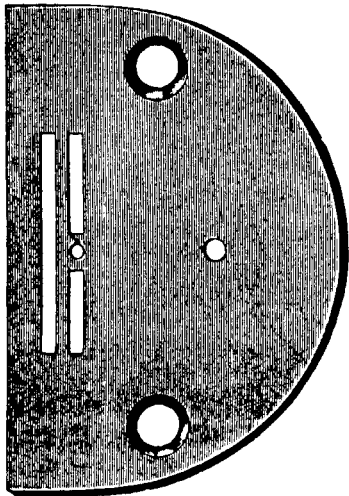
20115



20163



20042



20041

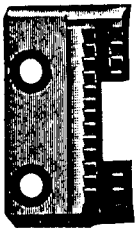
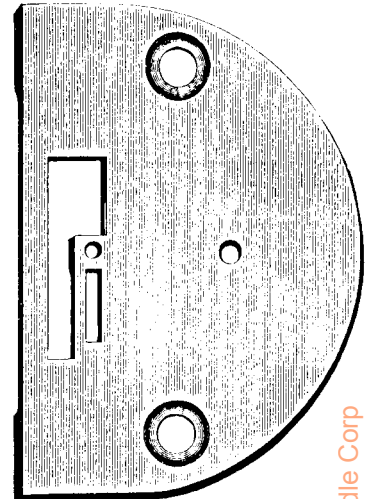
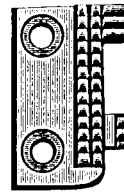


PLATE 1267—FULL SIZE

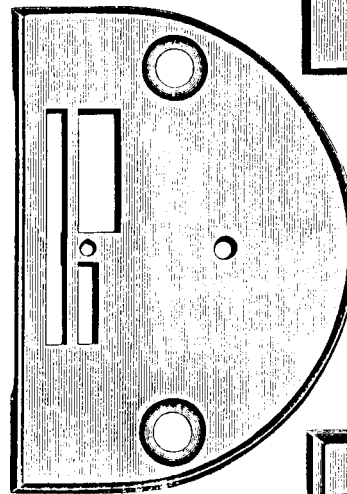
20350



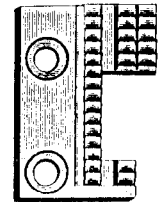
20349



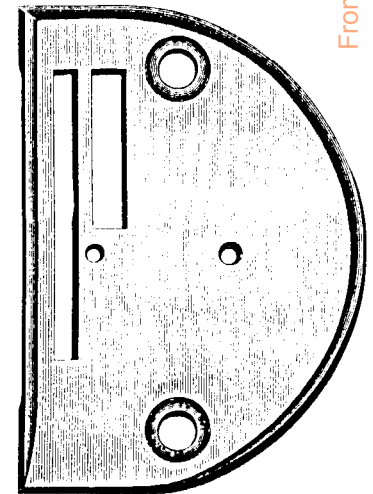
20353



20352



24353



24344

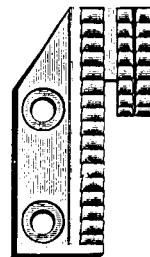
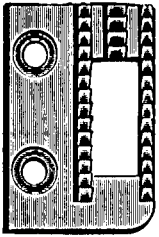
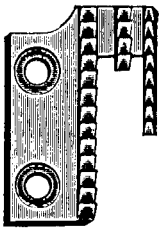


PLATE 1268—FULL SIZE

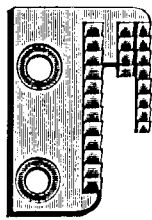
19400



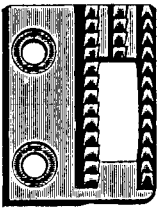
19408



19411



19414



19417

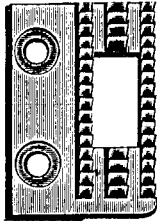
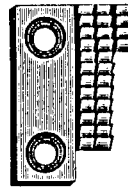


PLATE 1271—FULL SIZE

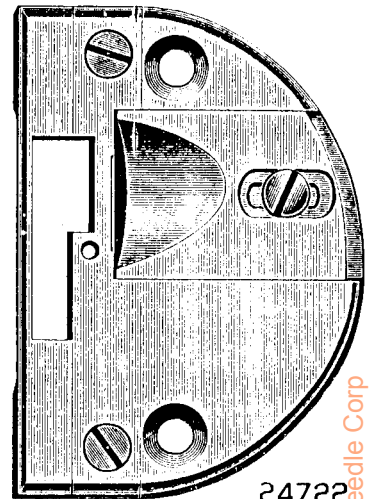
19103



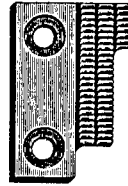
5730



5732



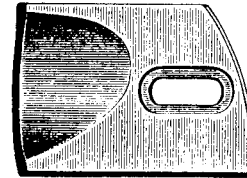
24573



19392



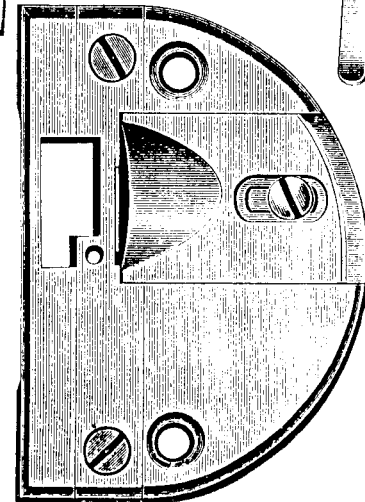
5731



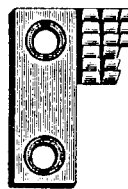
24722



24429



24408



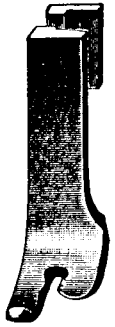
5726



From the library of: Diamond Needle Corp

PLATE 1308—FULL SIZE

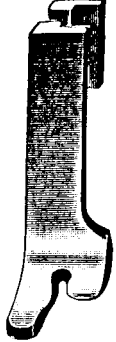
20150



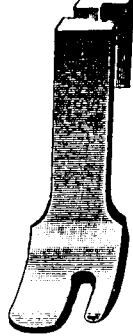
20118



12474



12258



12462



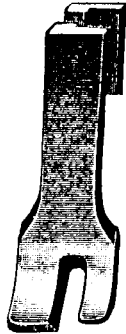
20020



12335



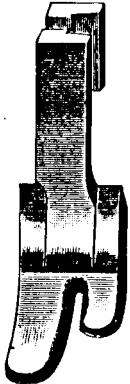
12261



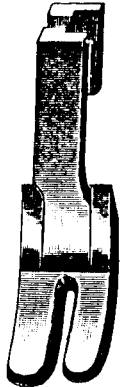
19225



19336



20134



20270



PLATE 1309—FULL SIZE

20157



12463

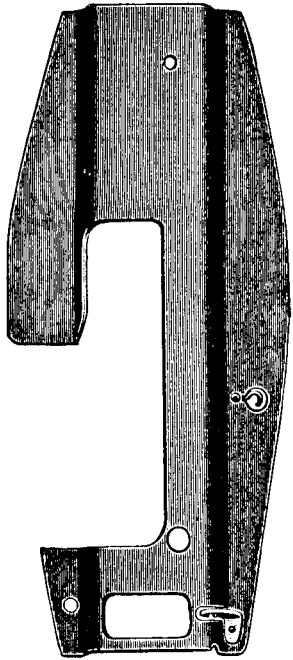


24489

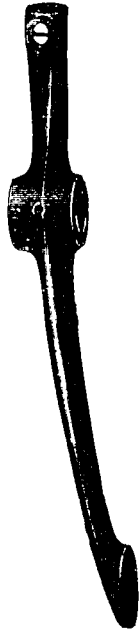


PLATE 1311—ONE-HALF SIZE

19355



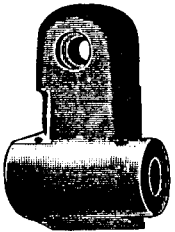
19371



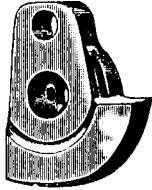
20363



19360



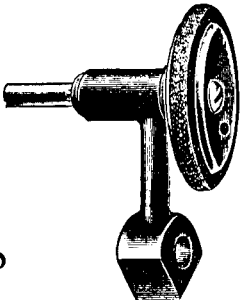
19365



20060



20308



24342

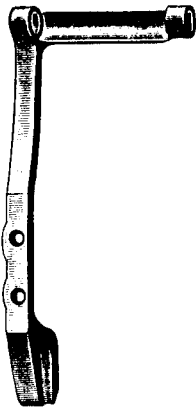
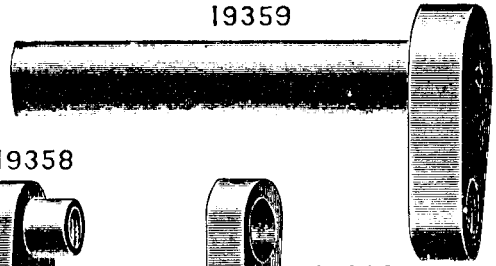
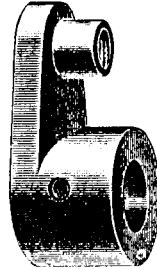


PLATE 1312—FULL SIZE

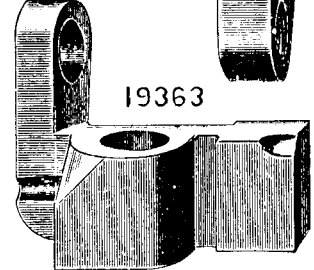
19359



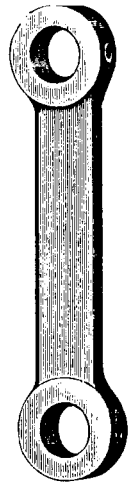
19358



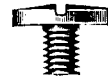
19363



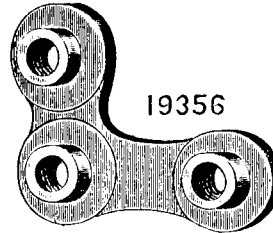
19357



199



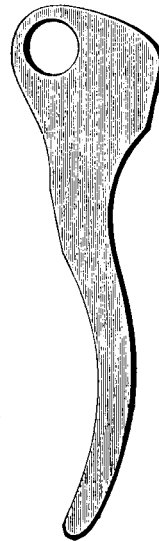
19356



965



4855



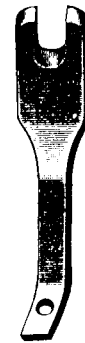
217



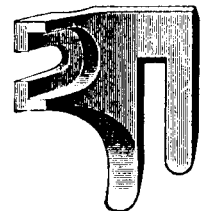
193



19364



19370



From the library of: Diamond Needle Corp

PLATE 1313—FULL SIZE

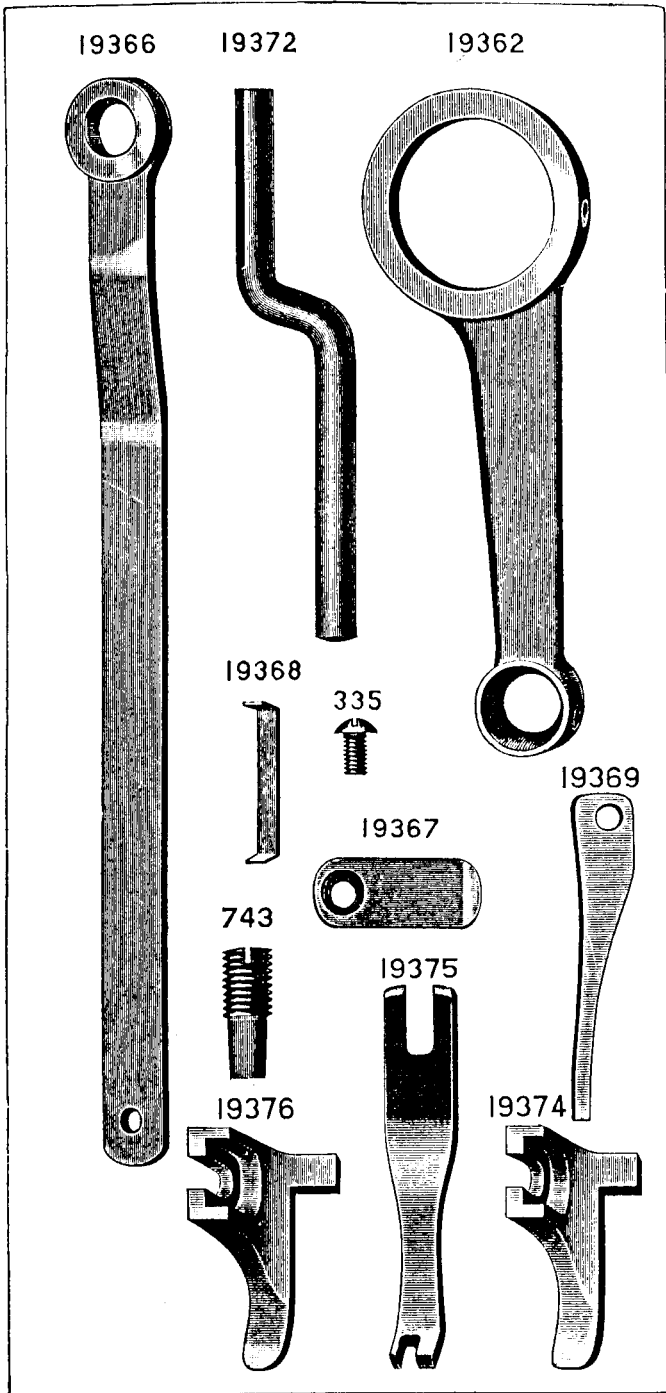


PLATE 1314—FULL SIZE

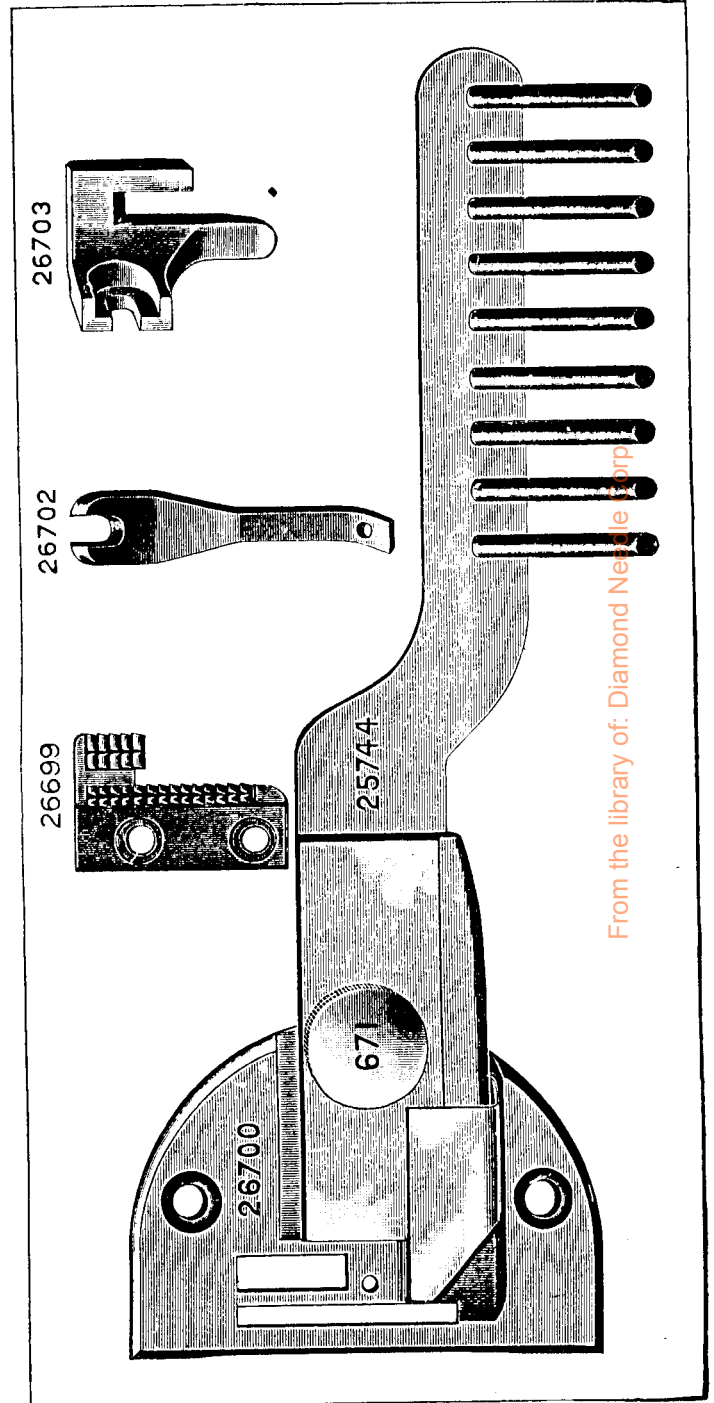


PLATE 1315—ONE-HALF SIZE

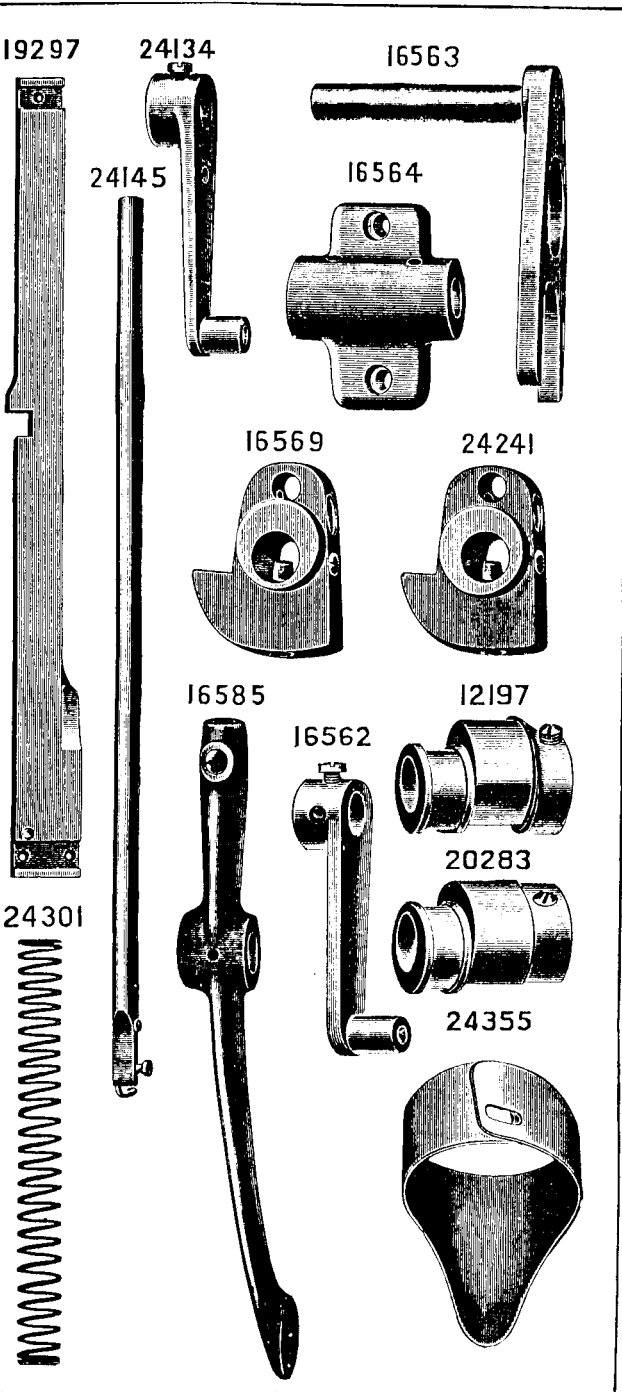
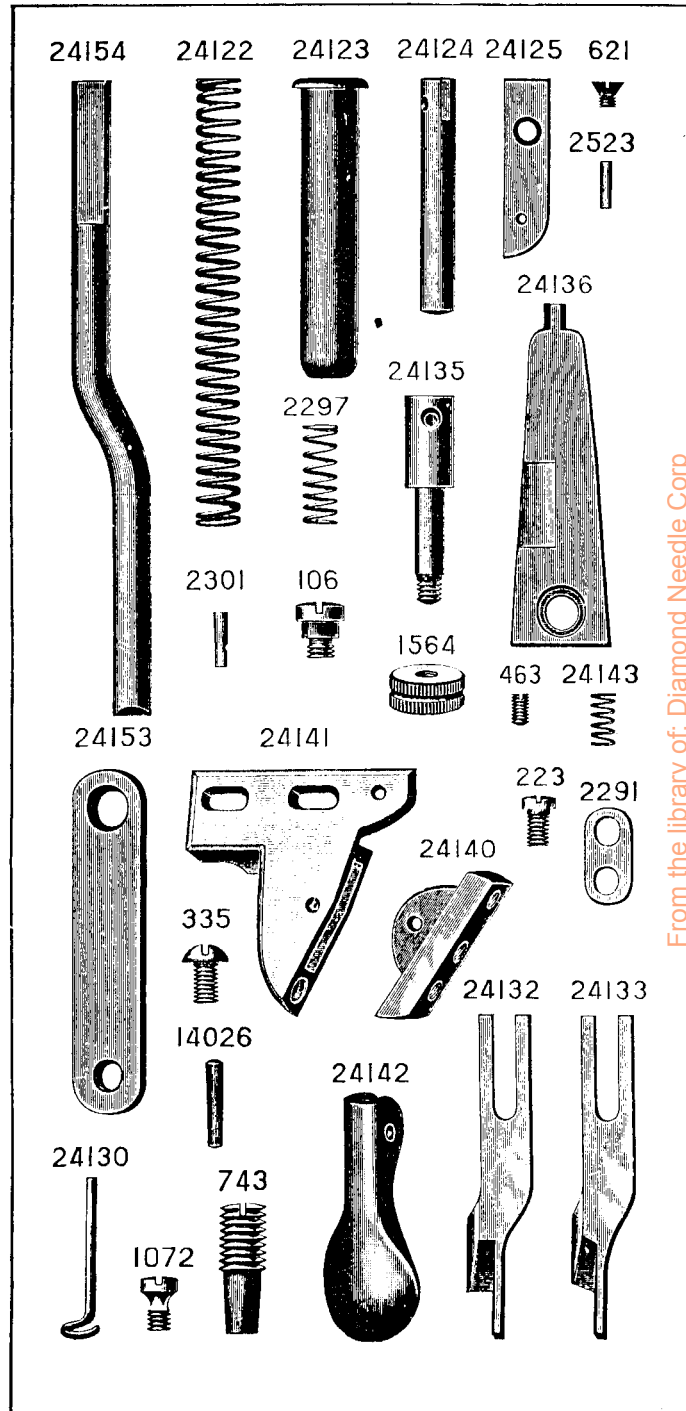


PLATE 1317—FULL SIZE



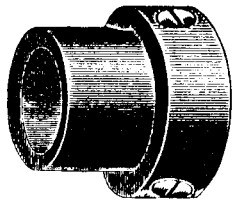
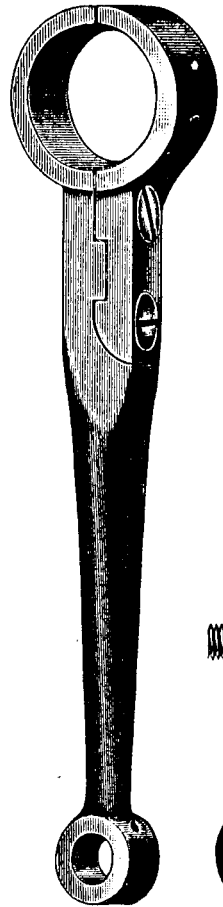
From the library of: Diamond Needle Corp

PLATE 1323—FULL SIZE

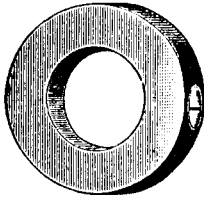
24219

24207

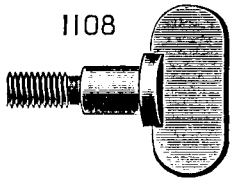
24199



24208

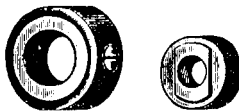


1108



6533

1641



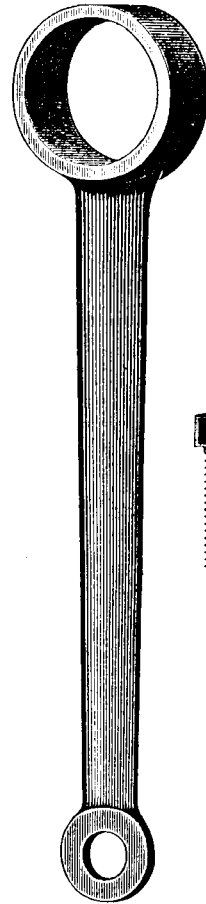
24211



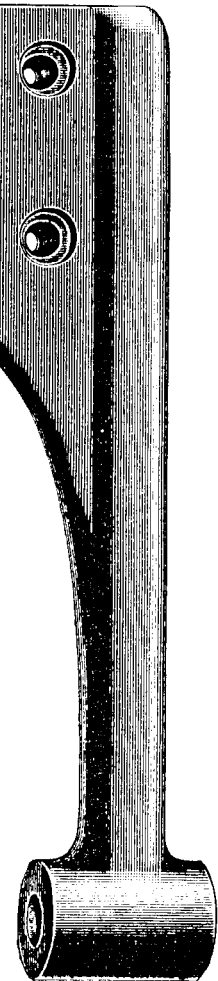
PLATE 1324—FULL SIZE

24209

24200



24201



24210



1102

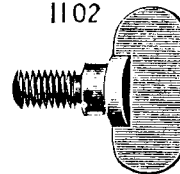


PLATE 1339—ONE-HALF SIZE

24026

24328

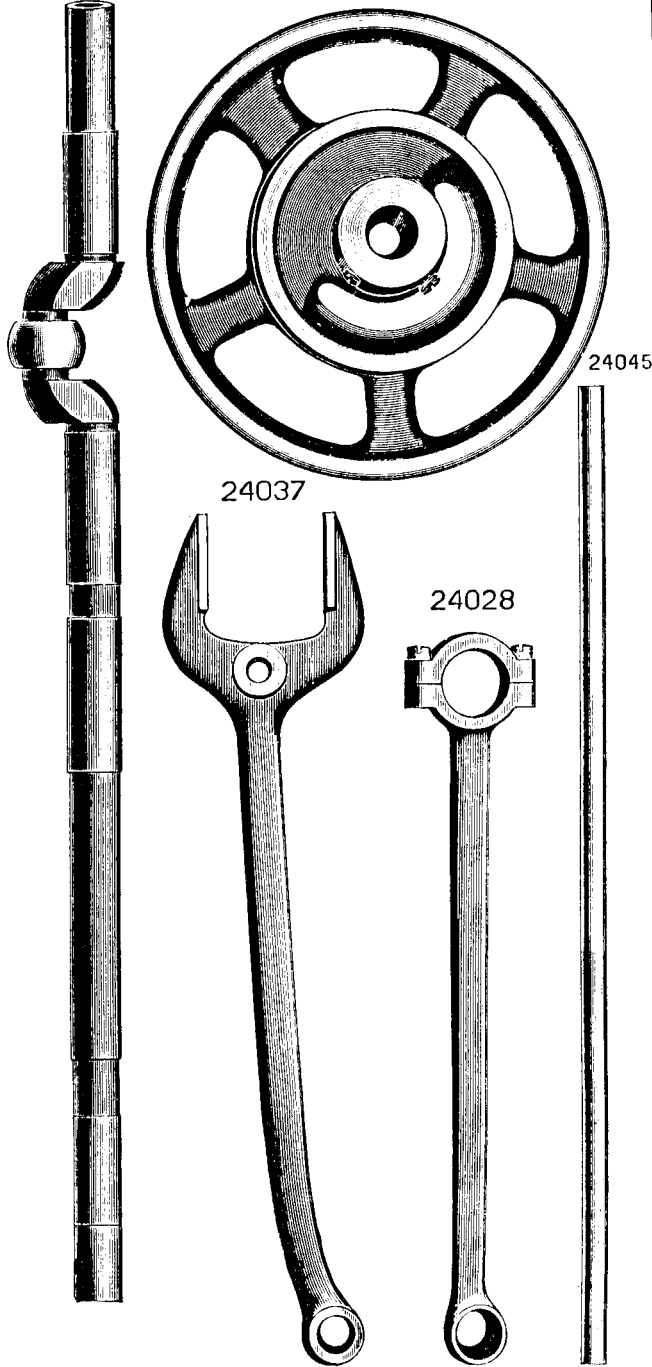
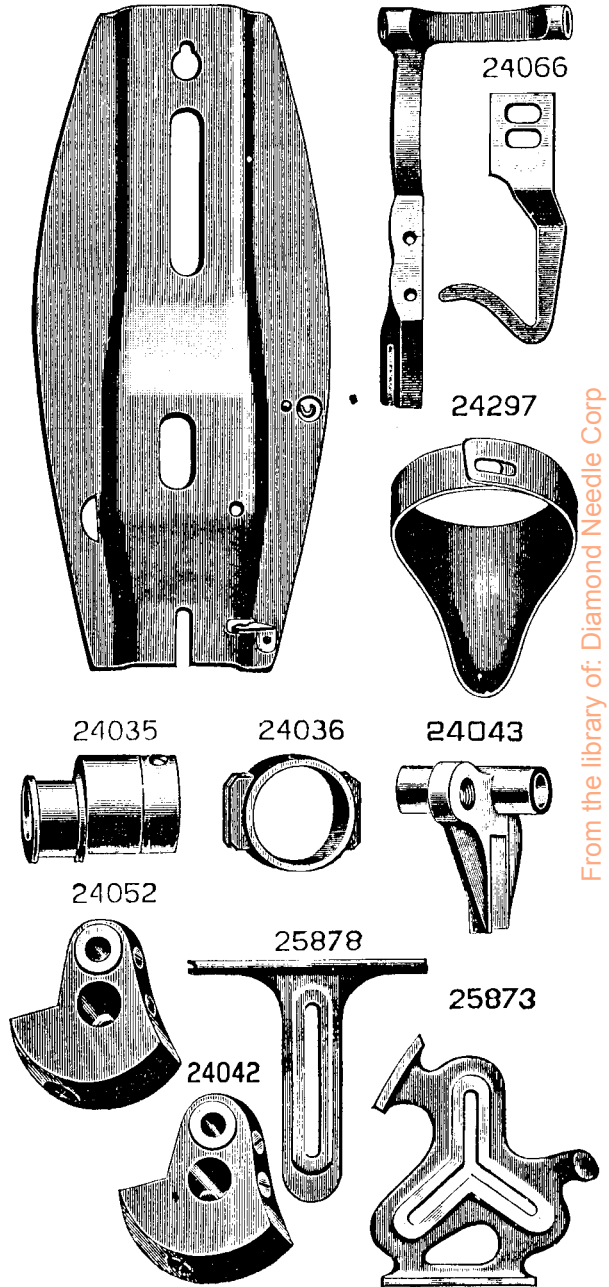


PLATE 1340—ONE-HALF SIZE

20058

24034



From the library of: Diamond Needle Corp

PLATE 1341—FULL SIZE

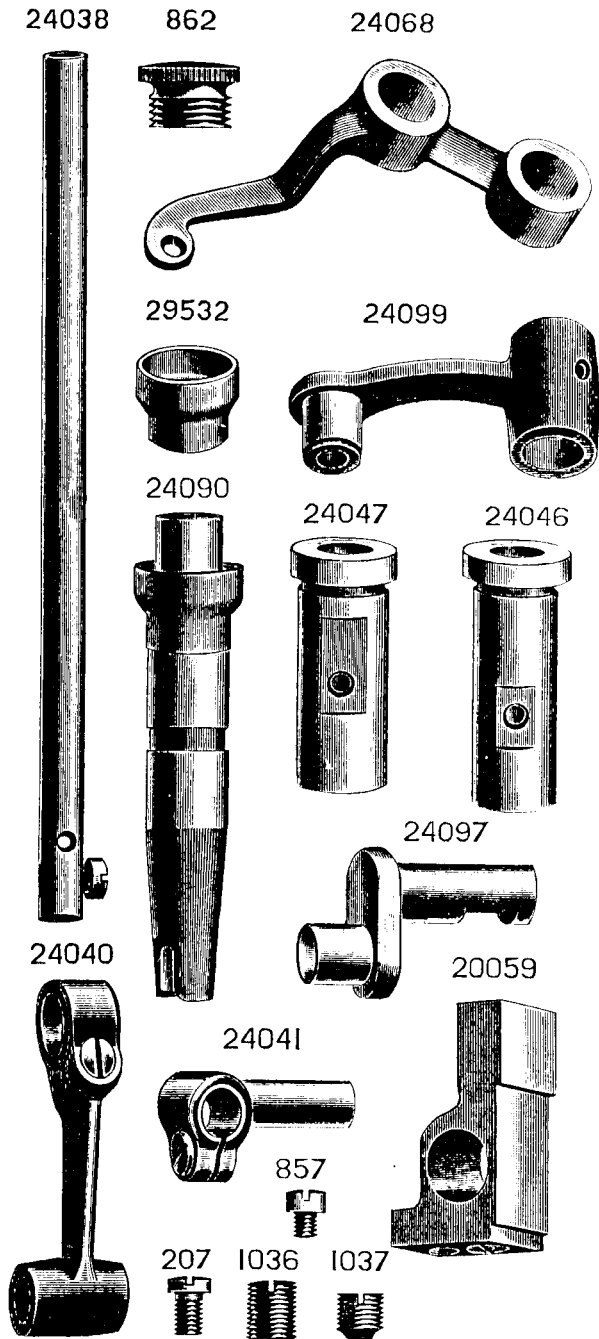
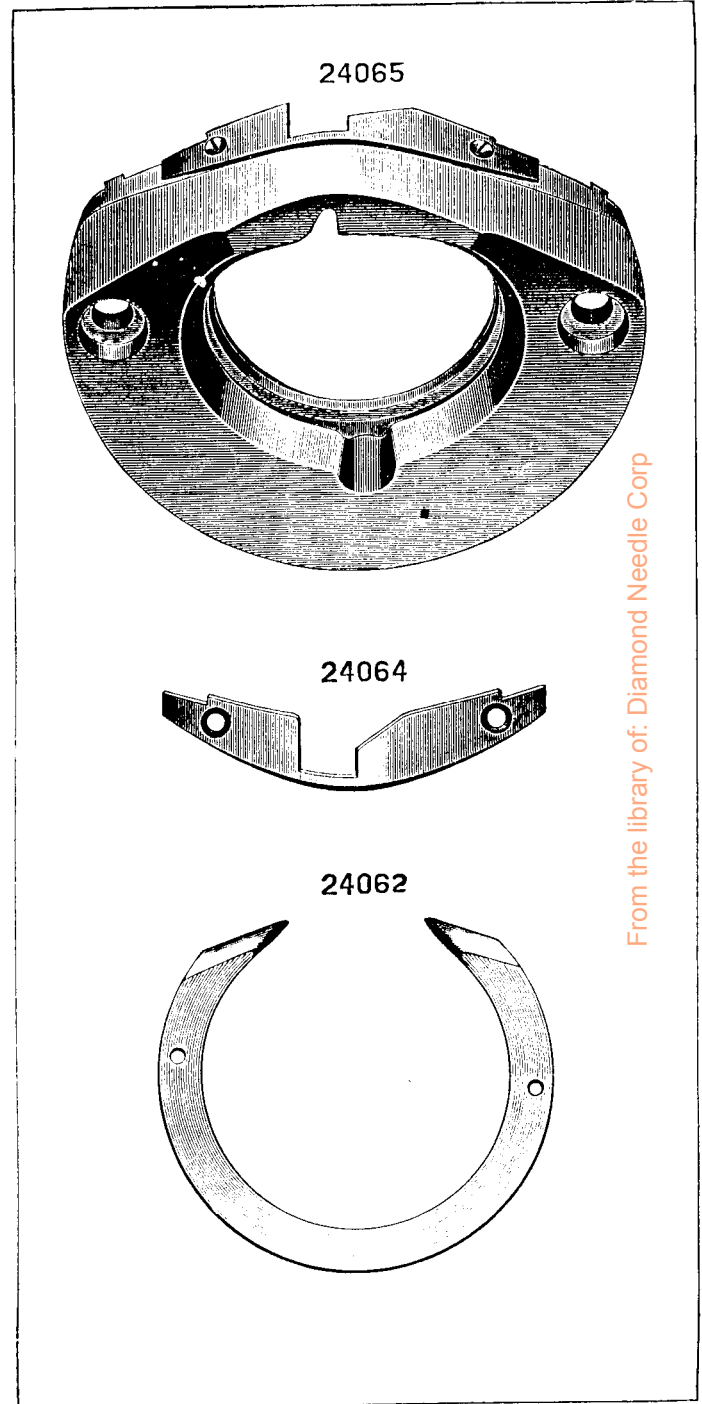


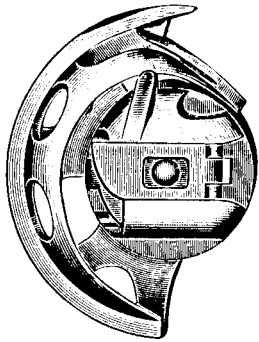
PLATE 1342—FULL SIZE



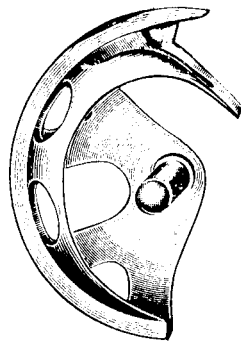
From the library of: Diamond Needle Corp

PLATE 1343—FULL SIZE

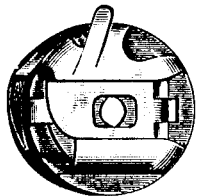
24059



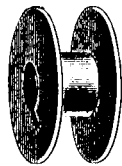
24057



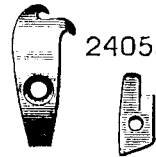
24056



24051



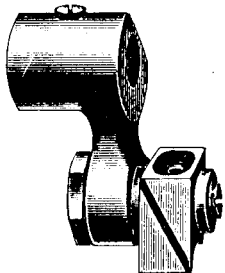
24058



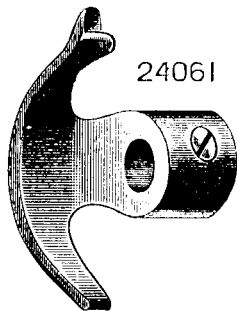
24055



24049



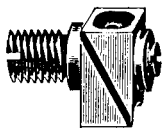
24061



1636



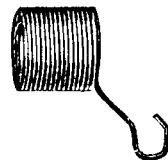
24050



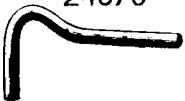
1035



24071



24078

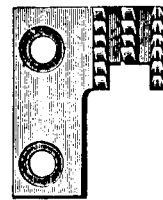


210

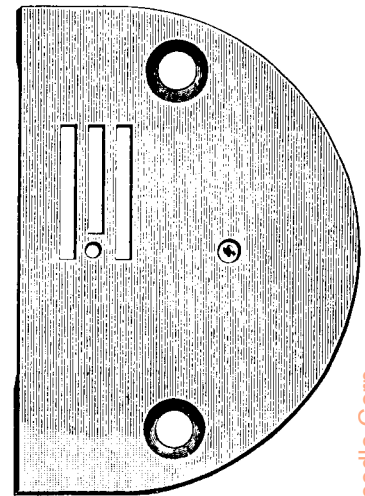


PLATE 1344—FULL SIZE

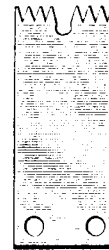
24303



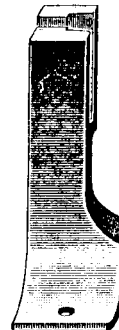
24306



24305



24304



24409



24204



665



24203



1550



24206

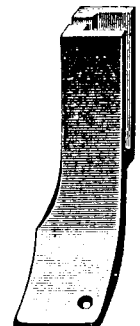


26890



26889

24411



24205



226



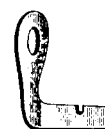
207



2291



24582



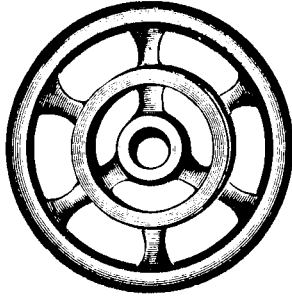
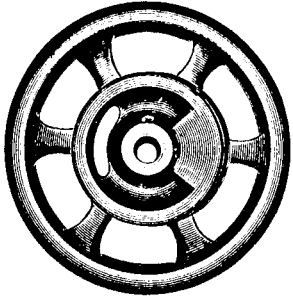
26888

From the library of: Diamond Needle Corp

PLATE 1348—ONE-FOURTH SIZE

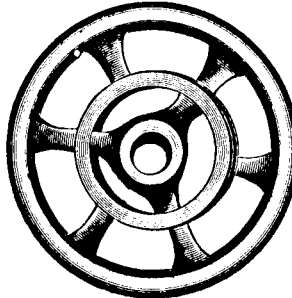
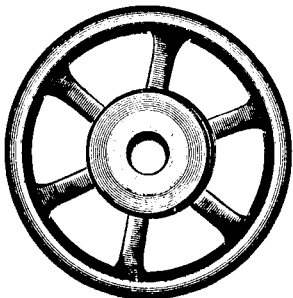
4370

2862



2135

2804

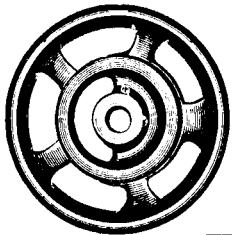


24296

2769

6335

2759

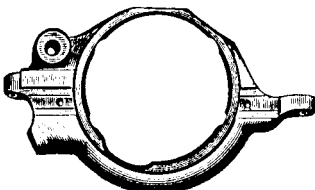
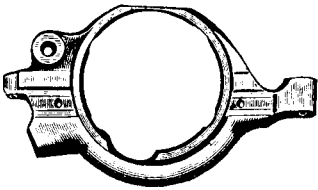


16526



19267

24190



16519



PLATE 1349—ONE-HALF SIZE

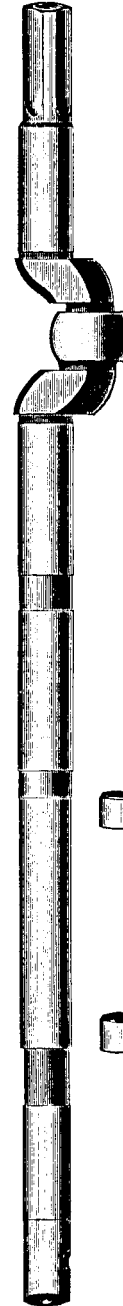
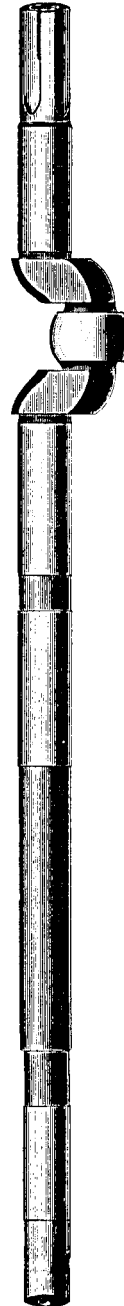
16511

24195

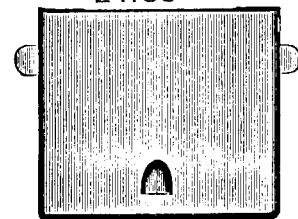
24346

19268

24178



24193



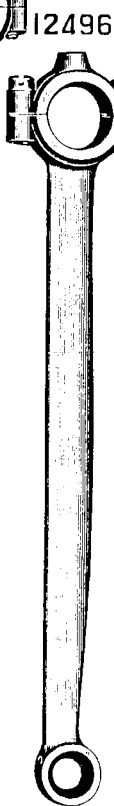
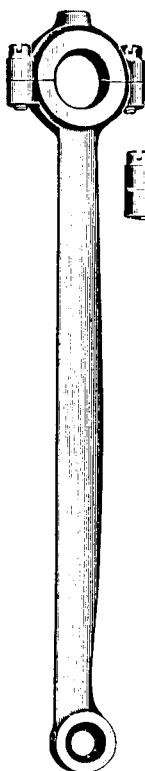
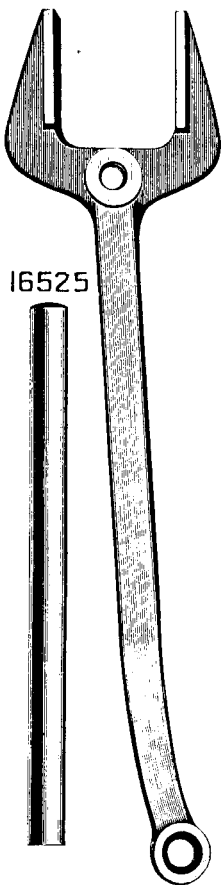
From the library of: Diamond Needle Corp

PLATE 1350—ONE-HALF SIZE

20284

12365

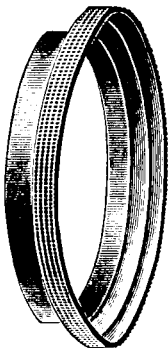
20197



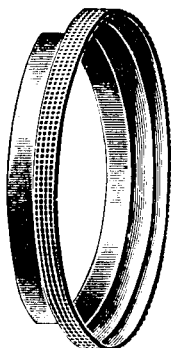
16525



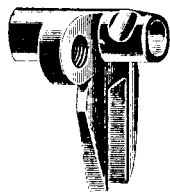
2664



24395



24104



12497

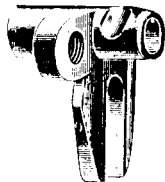
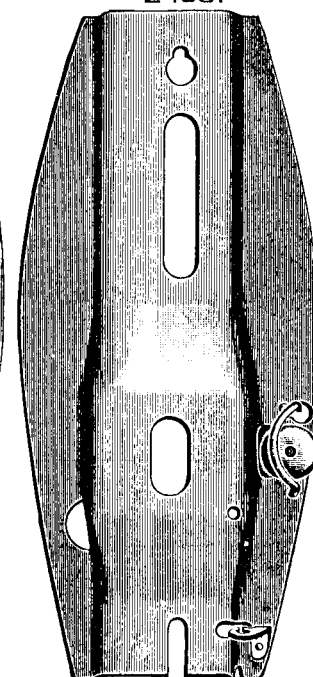
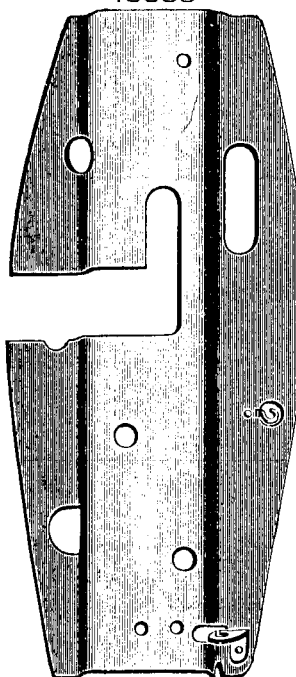


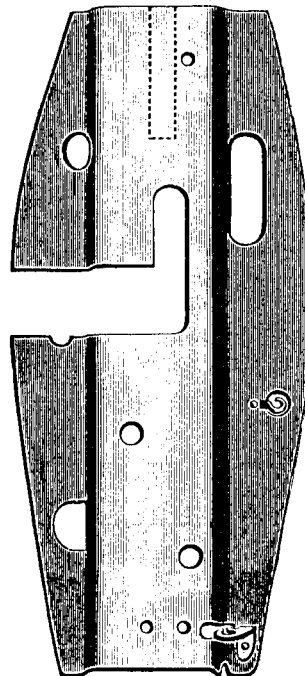
PLATE 1351—ONE-HALF SIZE

16559

24031



24394



From the library of: Diamond Needle Corp

PLATE 1352—ONE-HALF SIZE

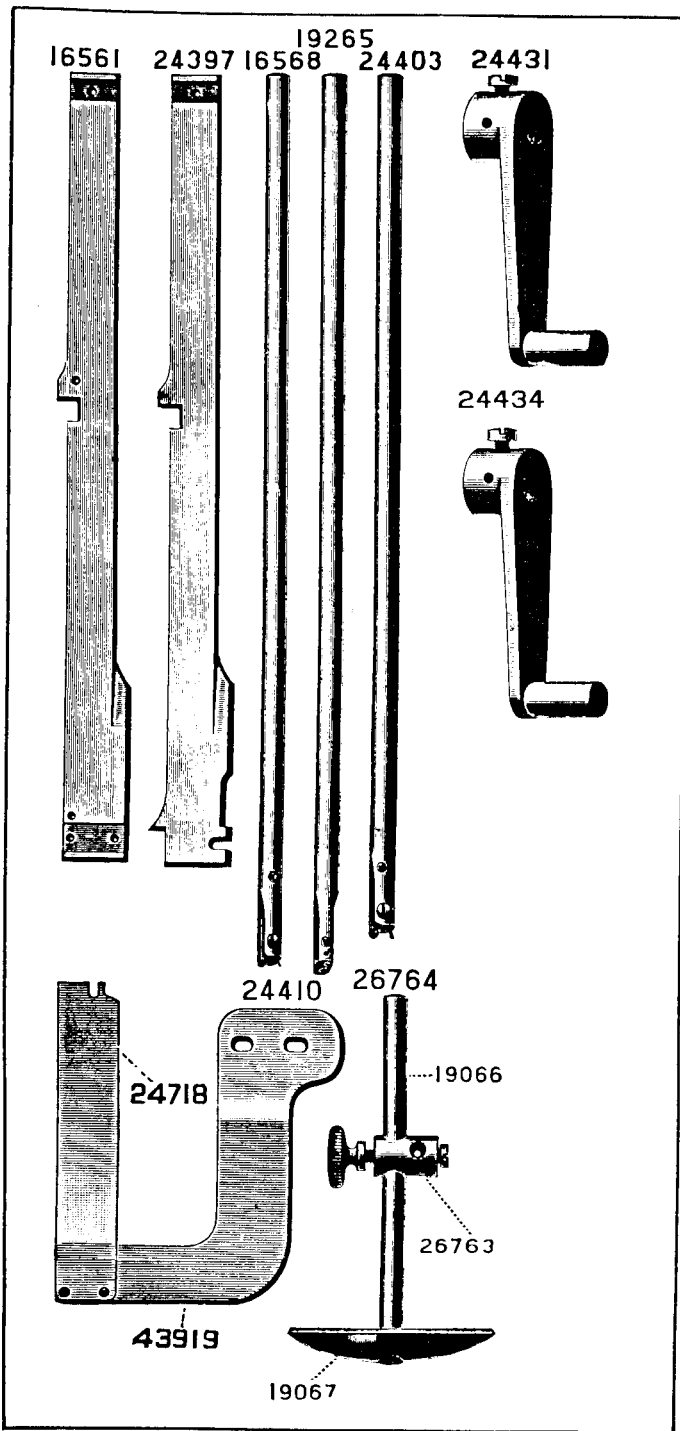


PLATE 1353—FULL SIZE

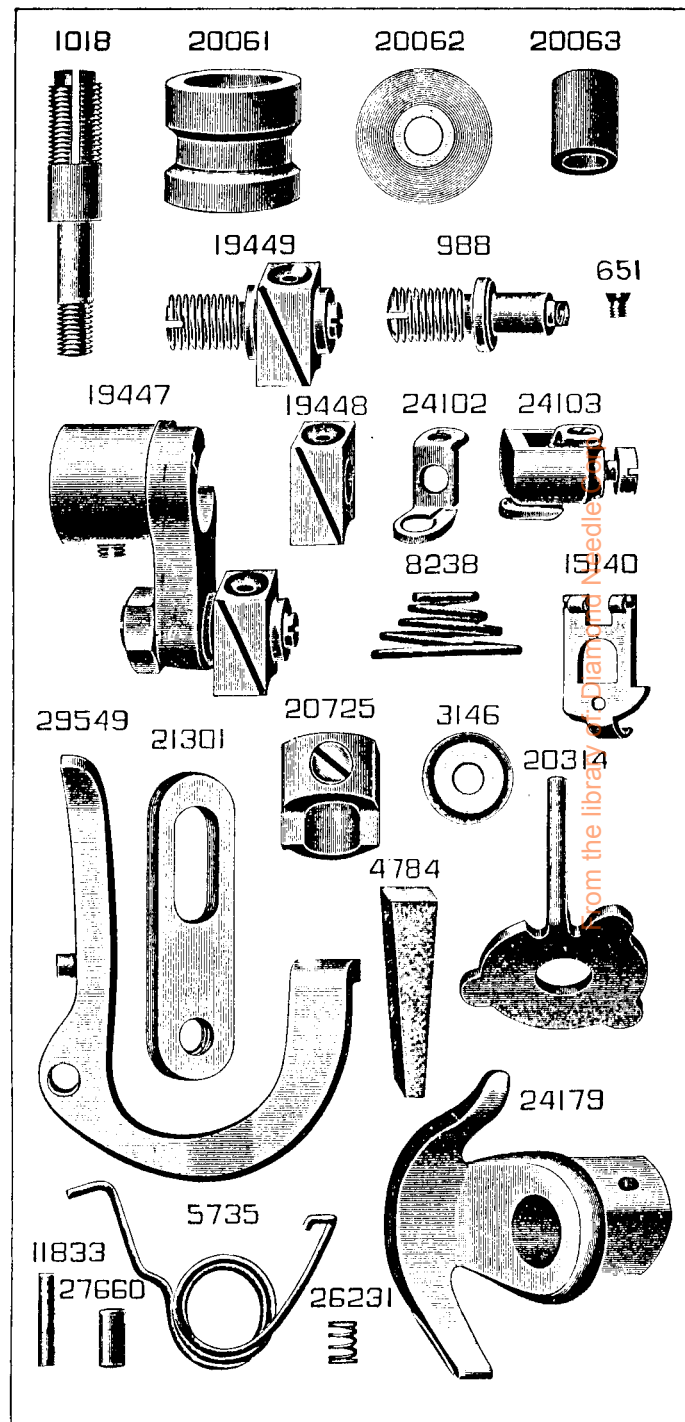


PLATE 1354—FULL SIZE

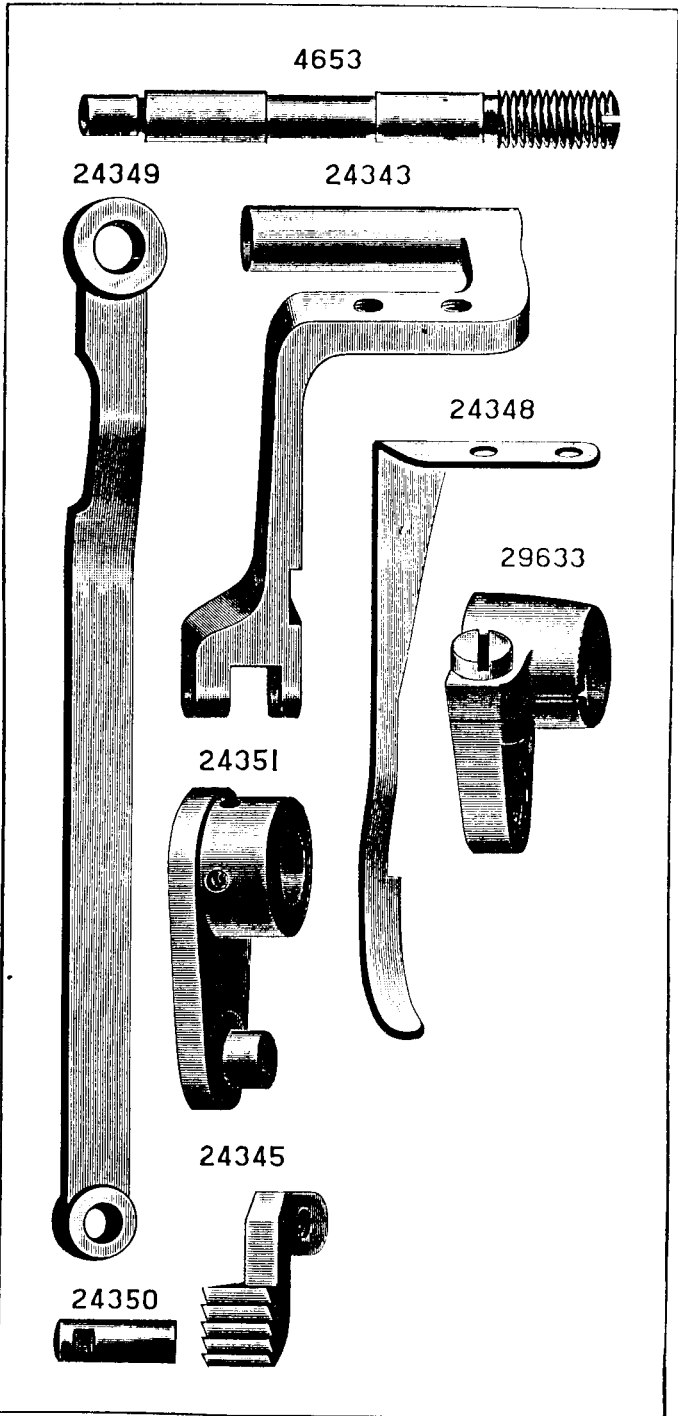


PLATE 1356—FULL SIZE

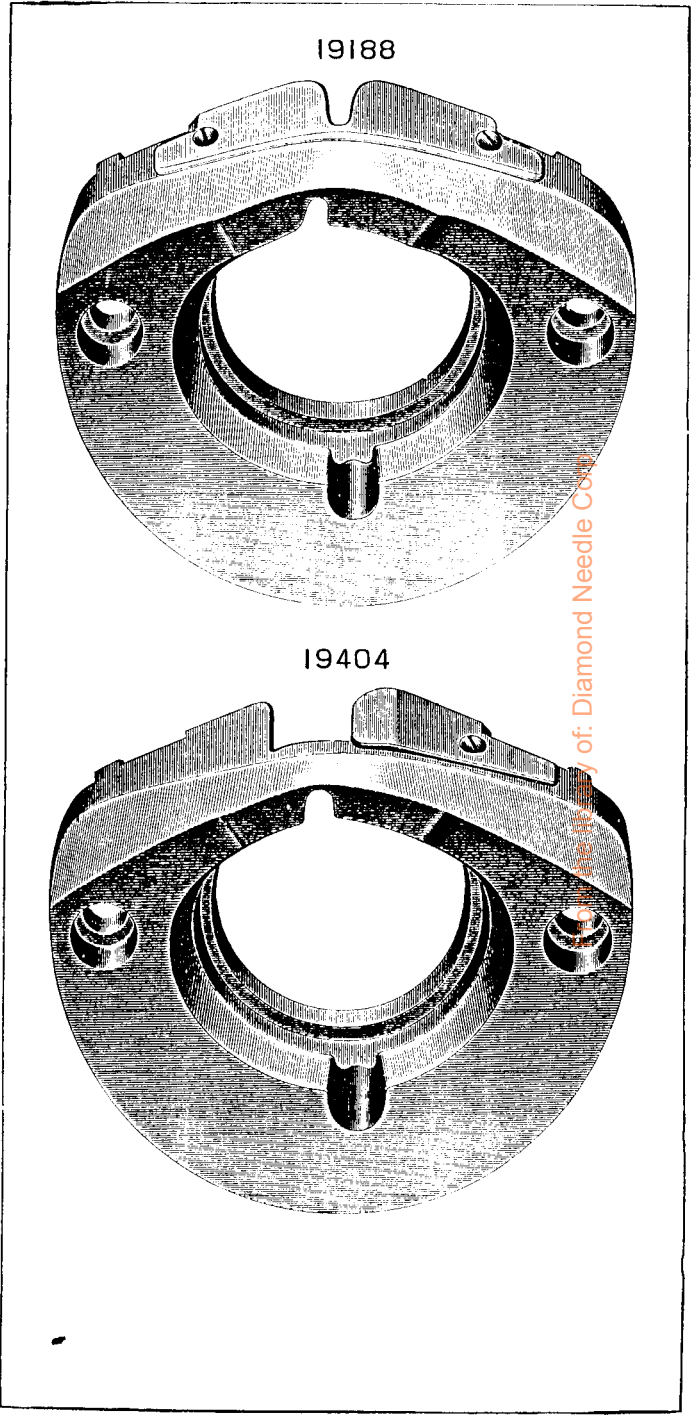
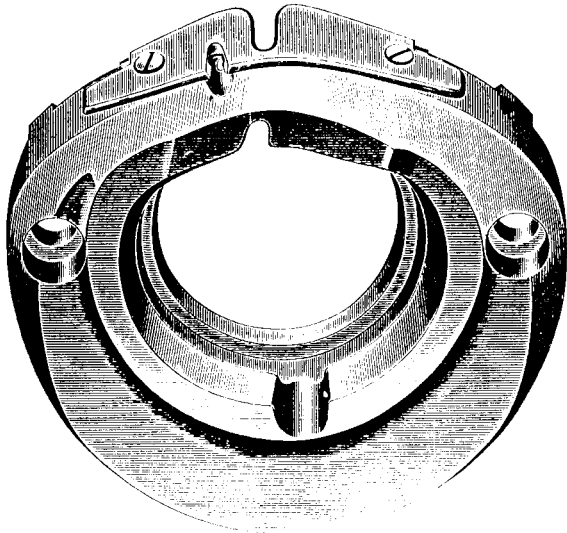


PLATE 1359—FULL SIZE

24157



24327

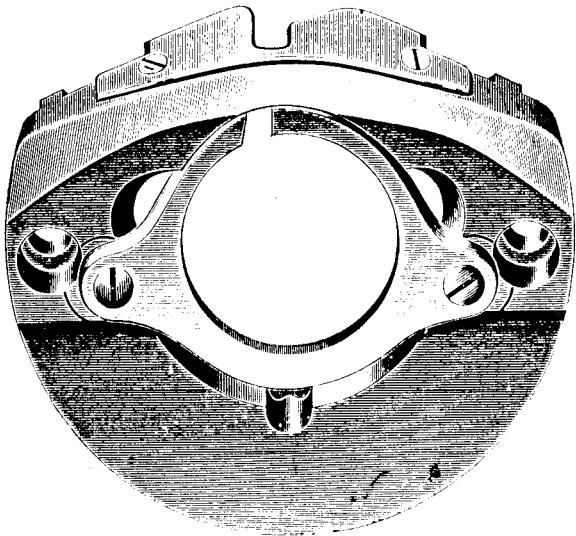
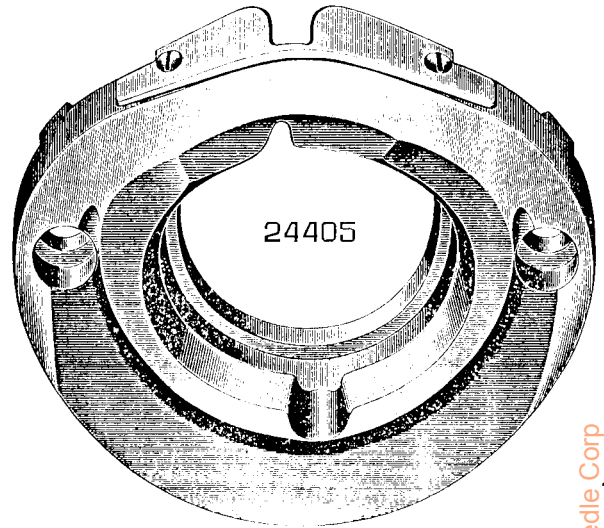
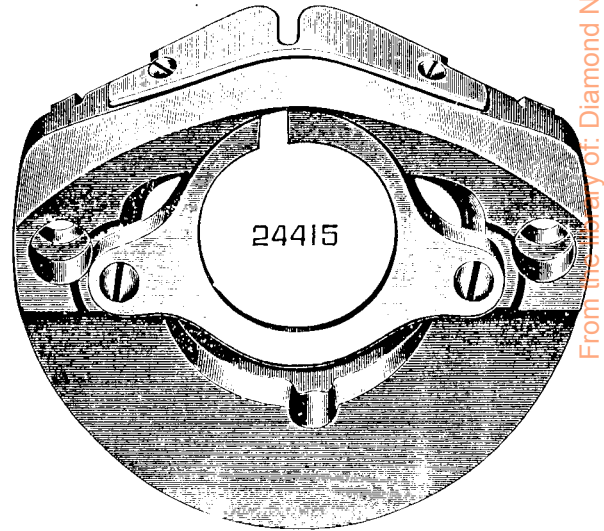


PLATE 1361—FULL SIZE

24405



24415



24412

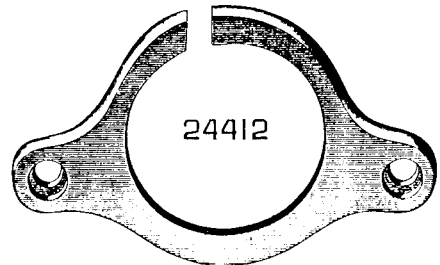
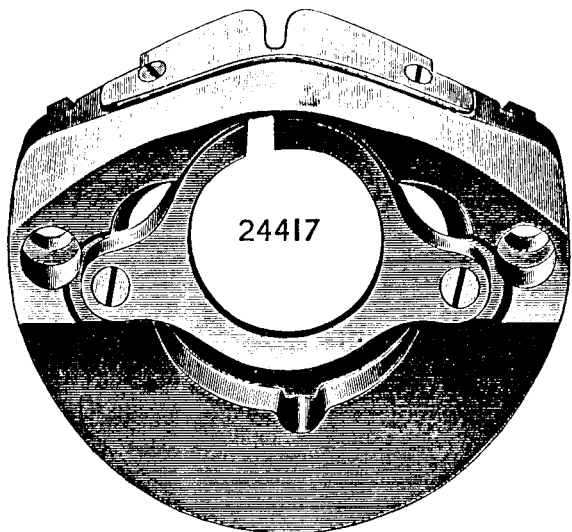
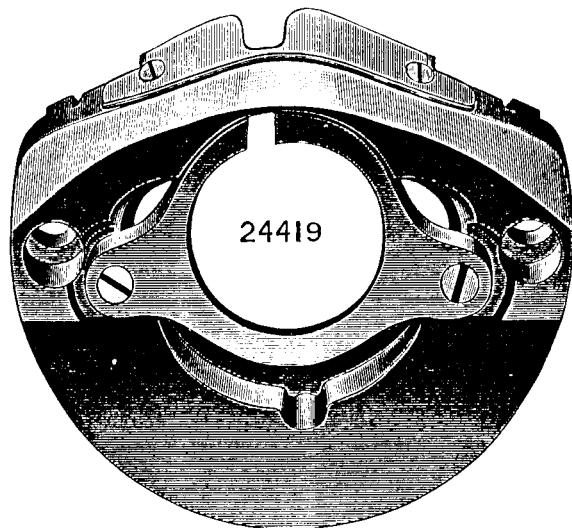


PLATE 1362—FULL SIZE



24414



24418



PLATE 1364—FULL SIZE

24438

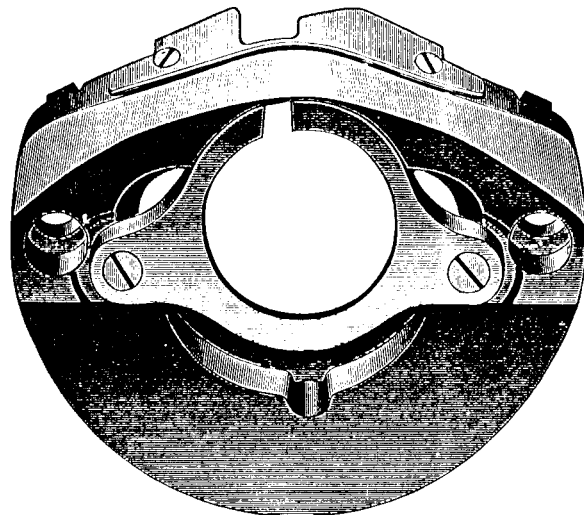


PLATE 1366—FULL SIZE

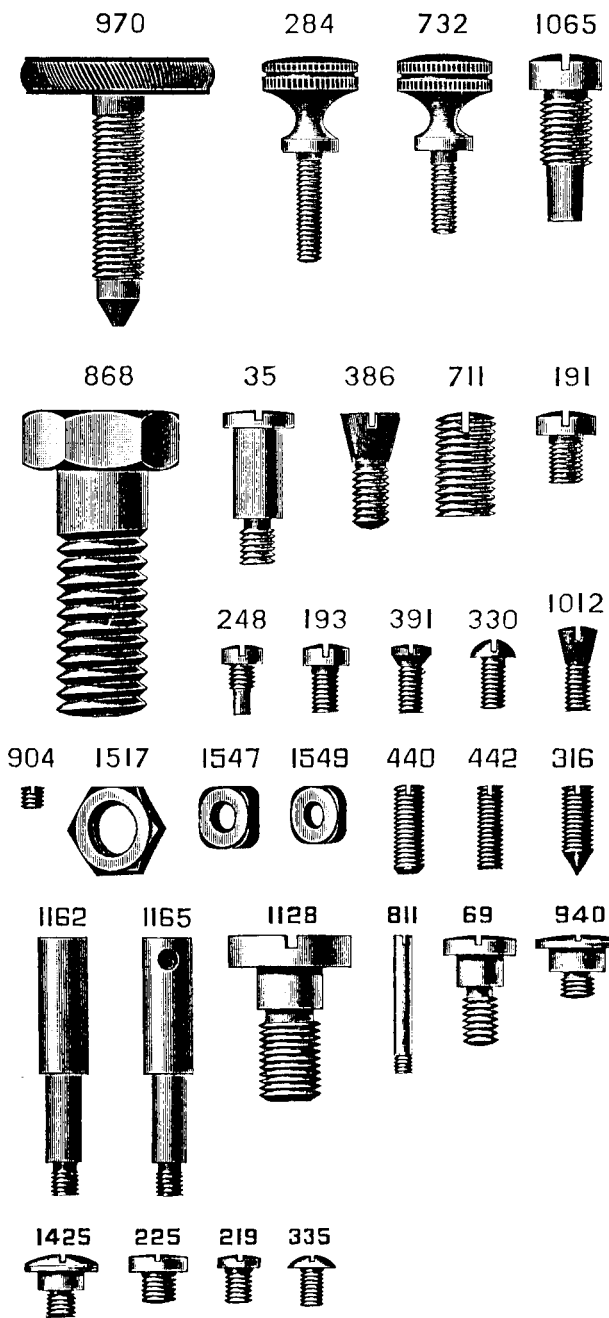
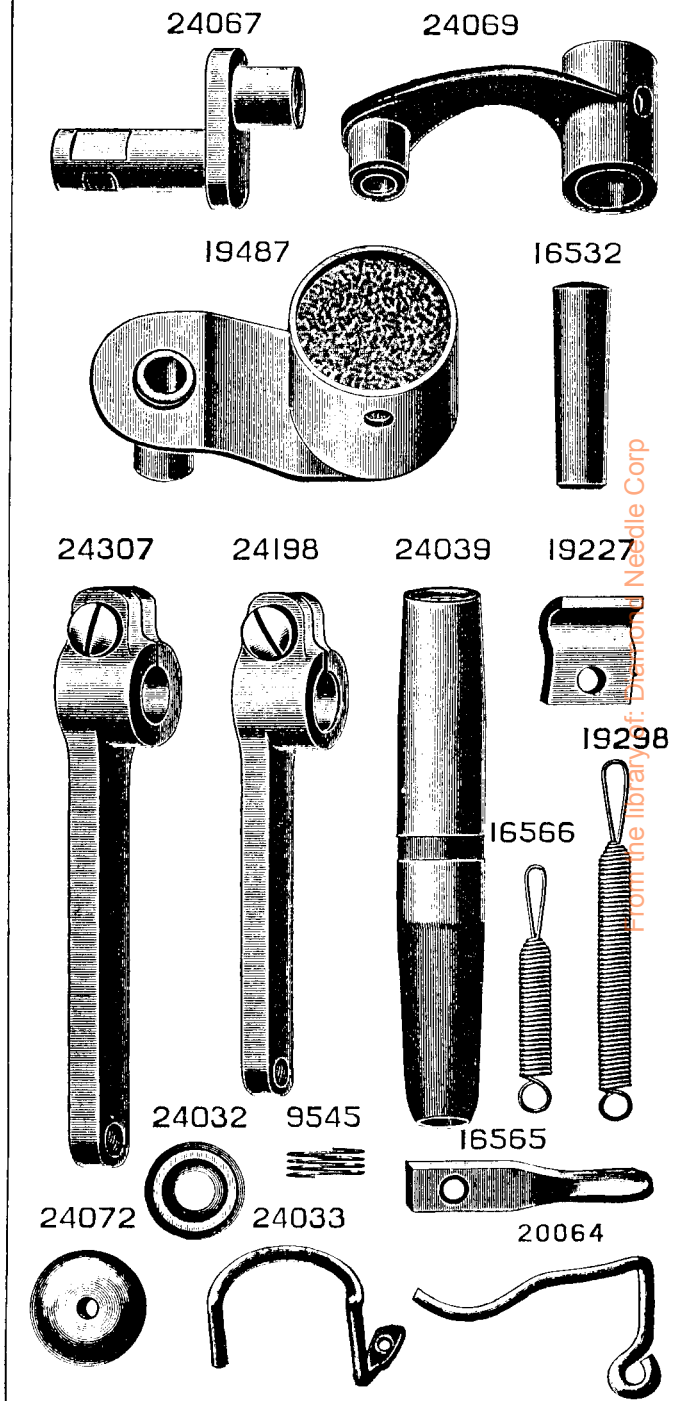


PLATE 1369—FULL SIZE



From the library of: Diamond Needle Corp

PLATE 1370—FULL SIZE

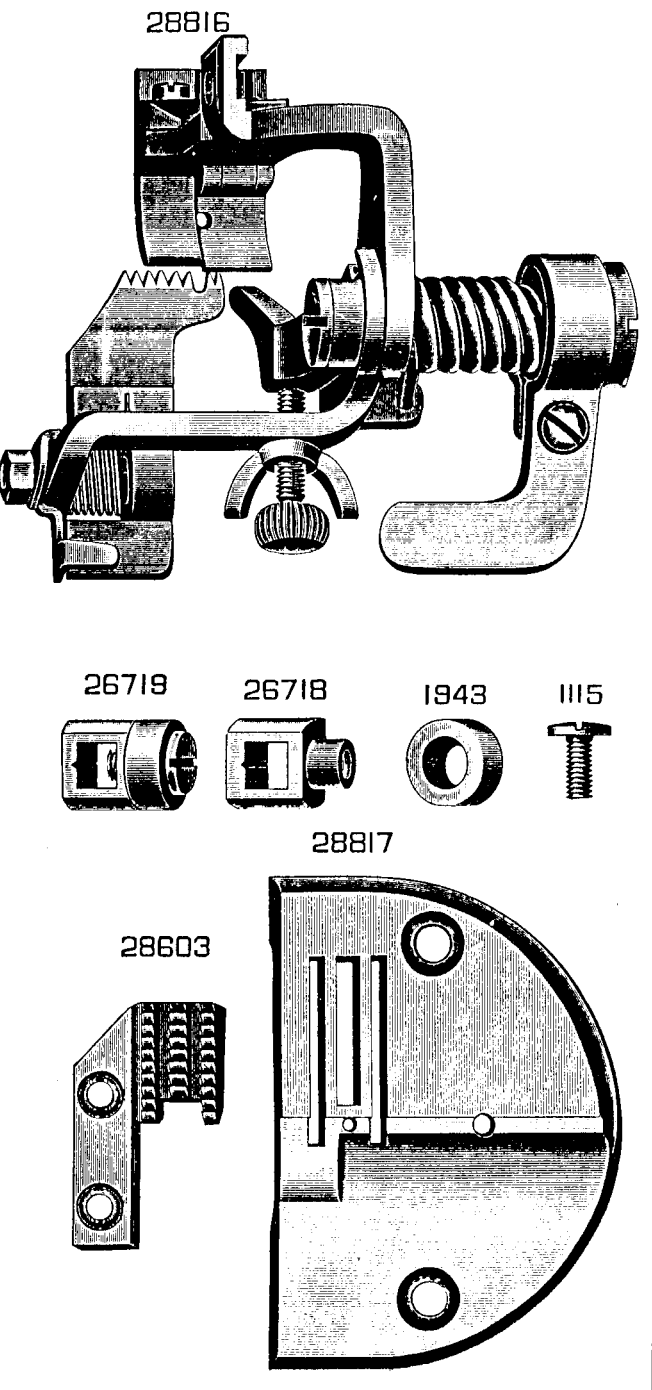


PLATE 1371—FULL SIZE

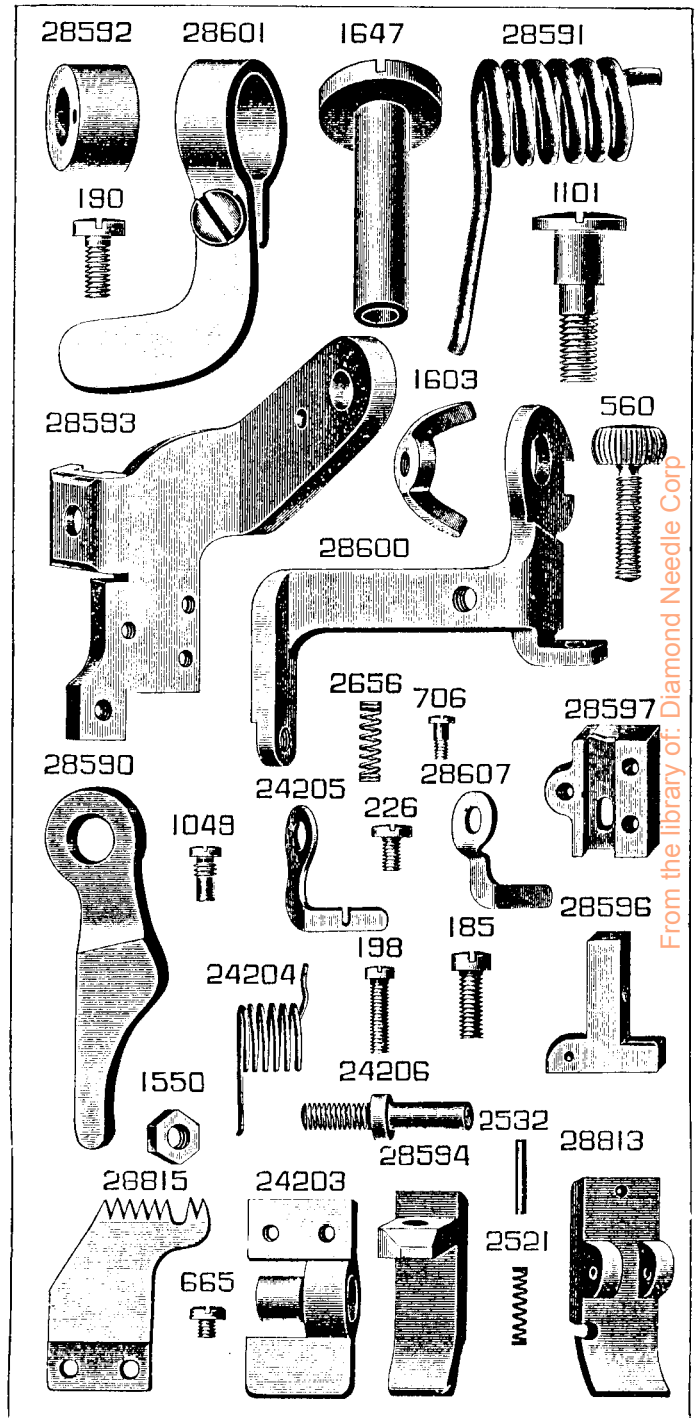
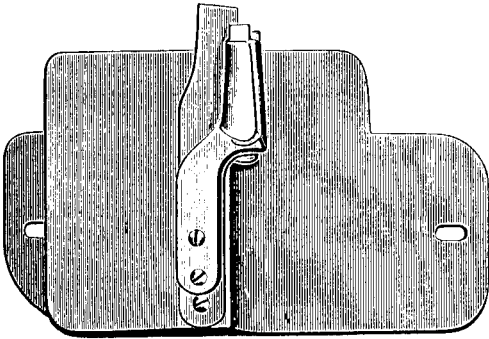
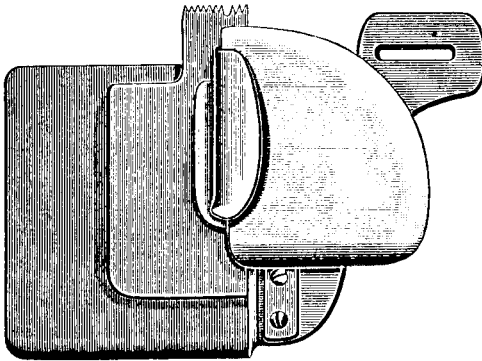


PLATE 1372—ONE-HALF SIZE

28606



28605



28818

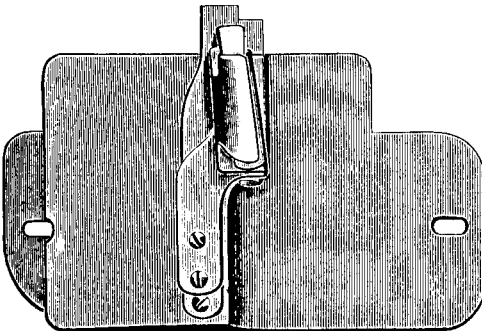
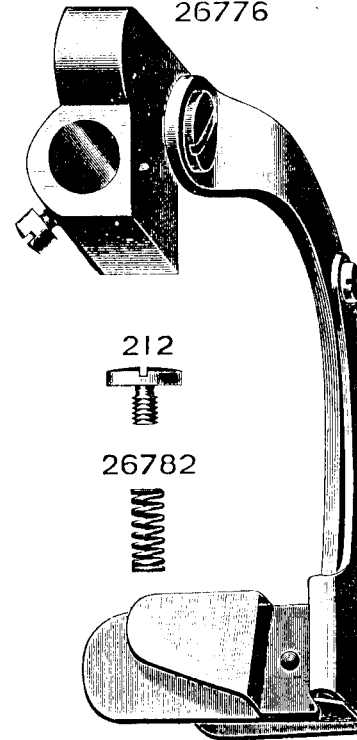
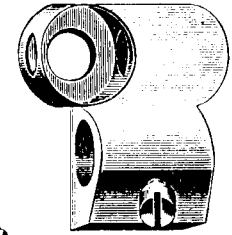


PLATE 1374—FULL SIZE

26776



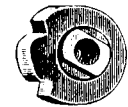
26783



212



26780



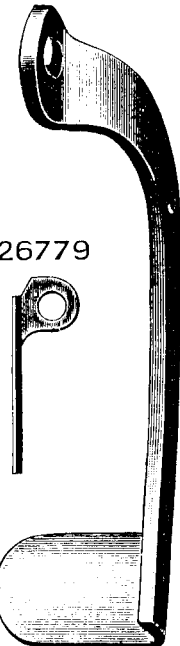
26782



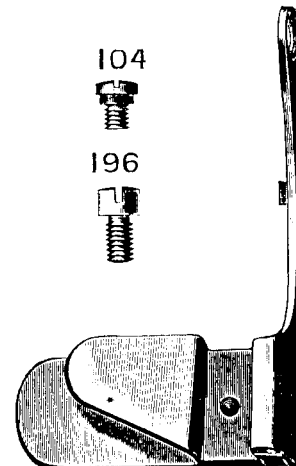
26781



26777



26778



104

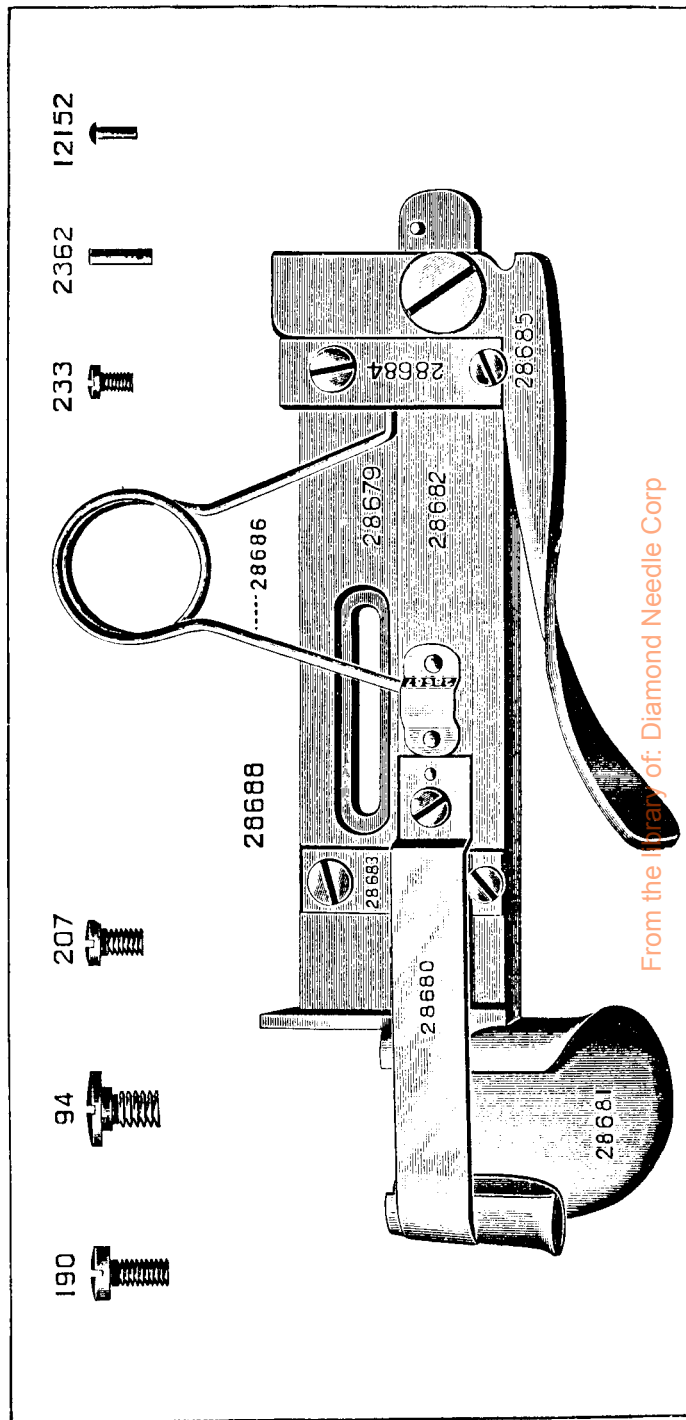
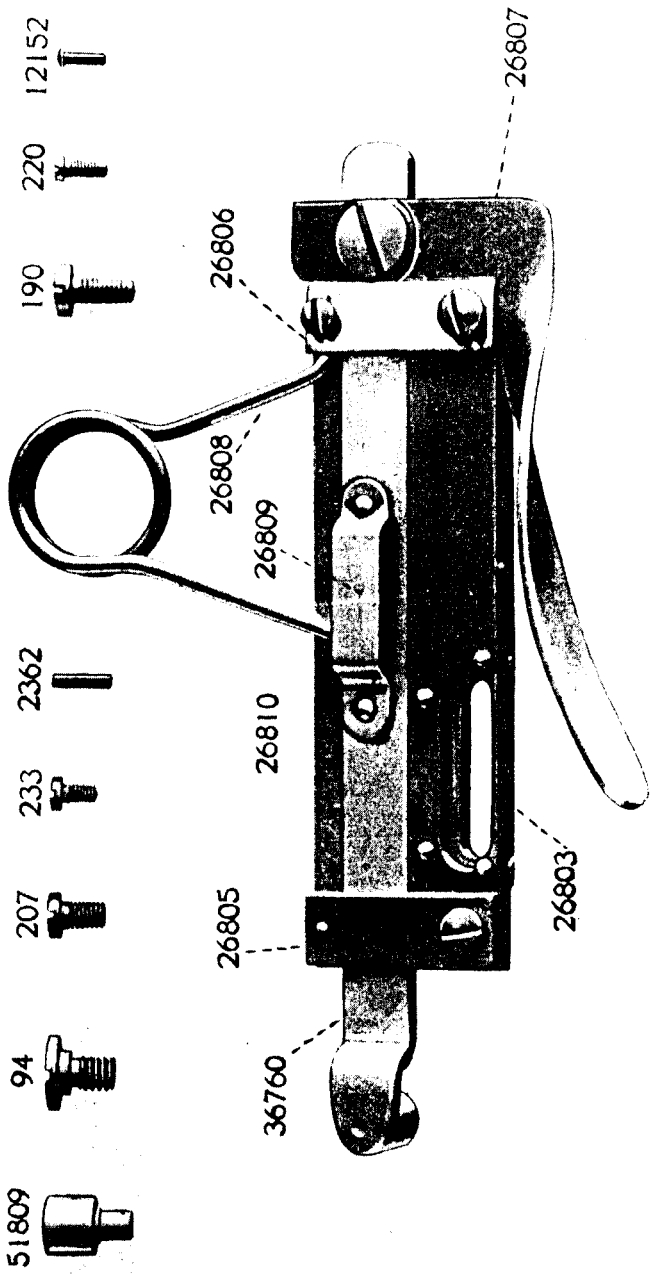


196

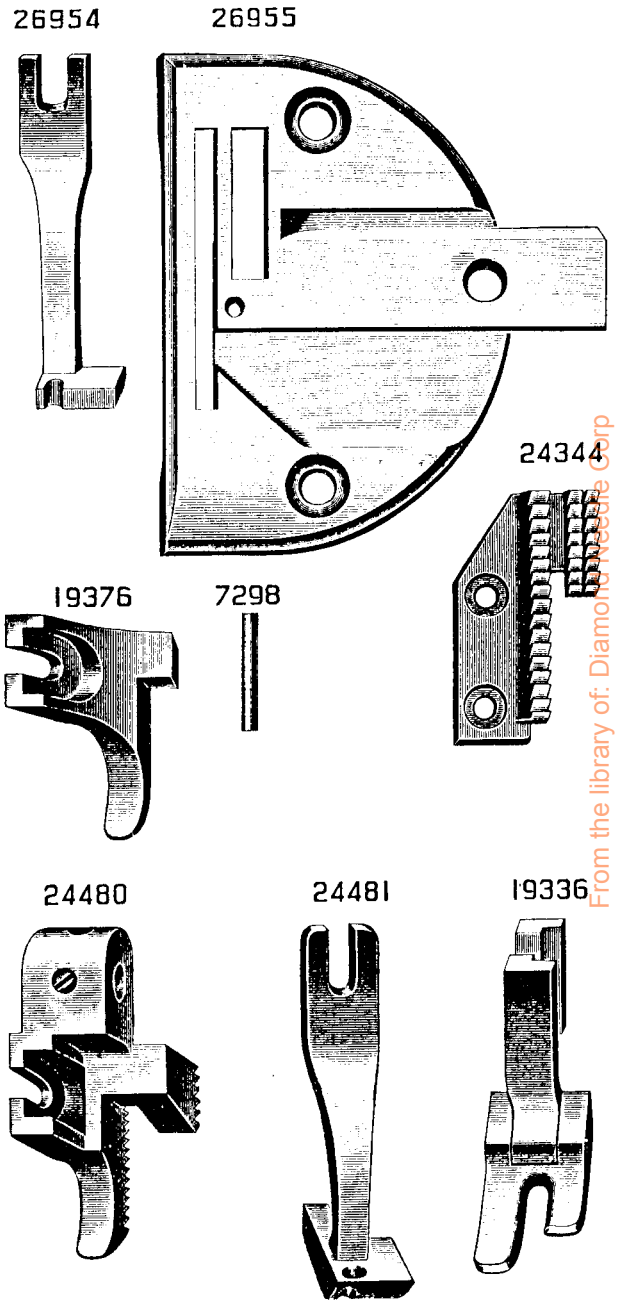
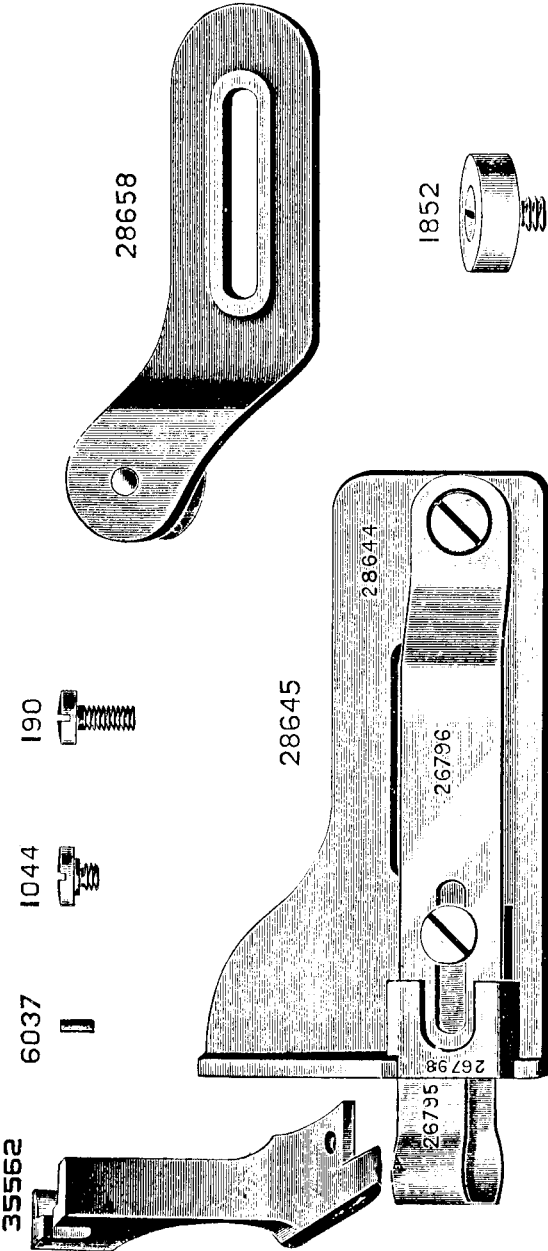


26779



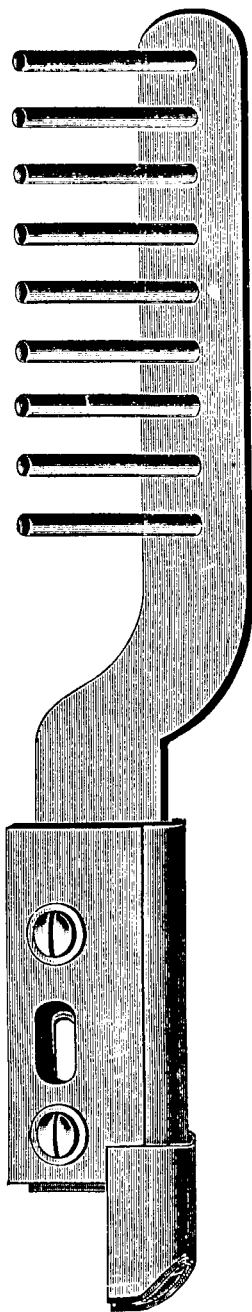


From the Library of: Diamond Needle Corp

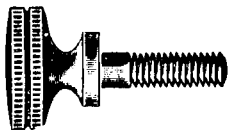


From the library of: [Diamant Press Corp](#)

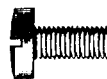
26953



283



898



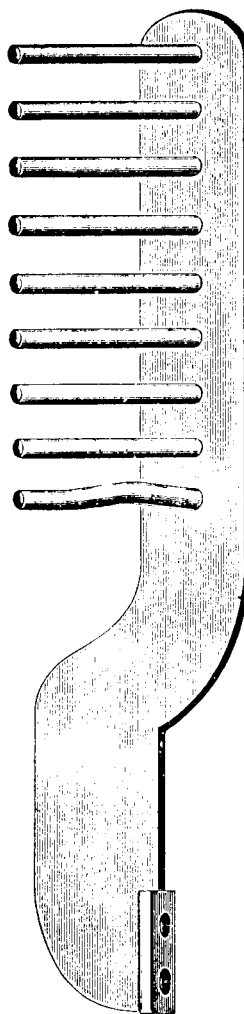
7071



193



28337



233



28334

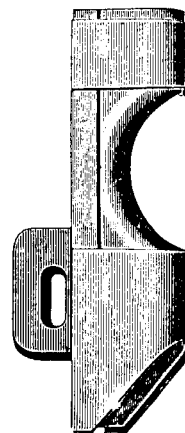
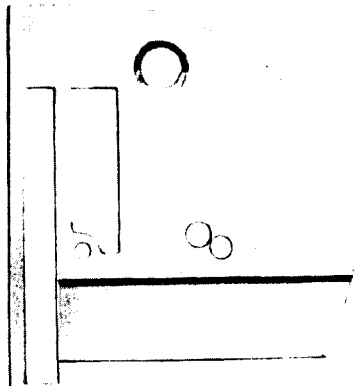


PLATE 1381—FULL SIZE

28676



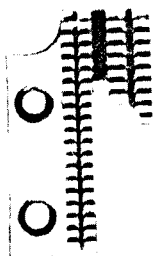
28677



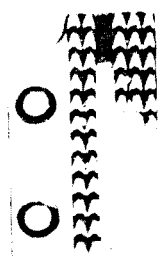
120208



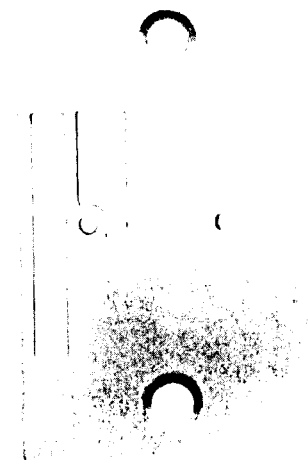
26003



120001



44137

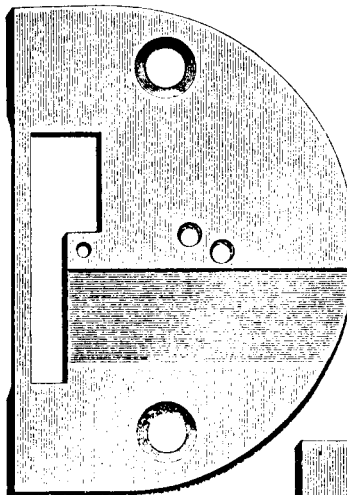


44136

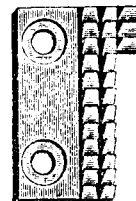


PLATE 1382—FULL SIZE

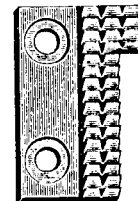
28655



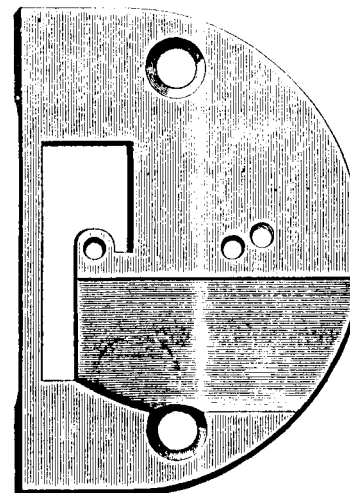
12369



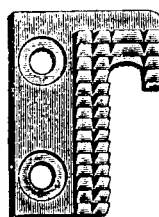
12457



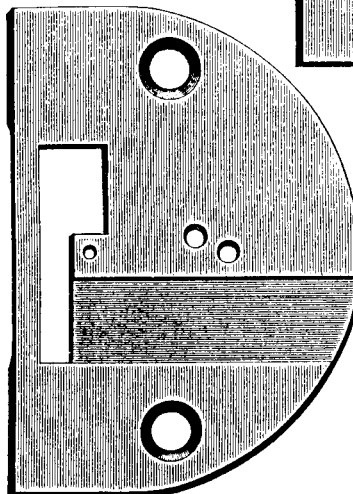
28775



12370



28783



20106

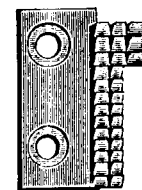


PLATE 1383—FULL SIZE

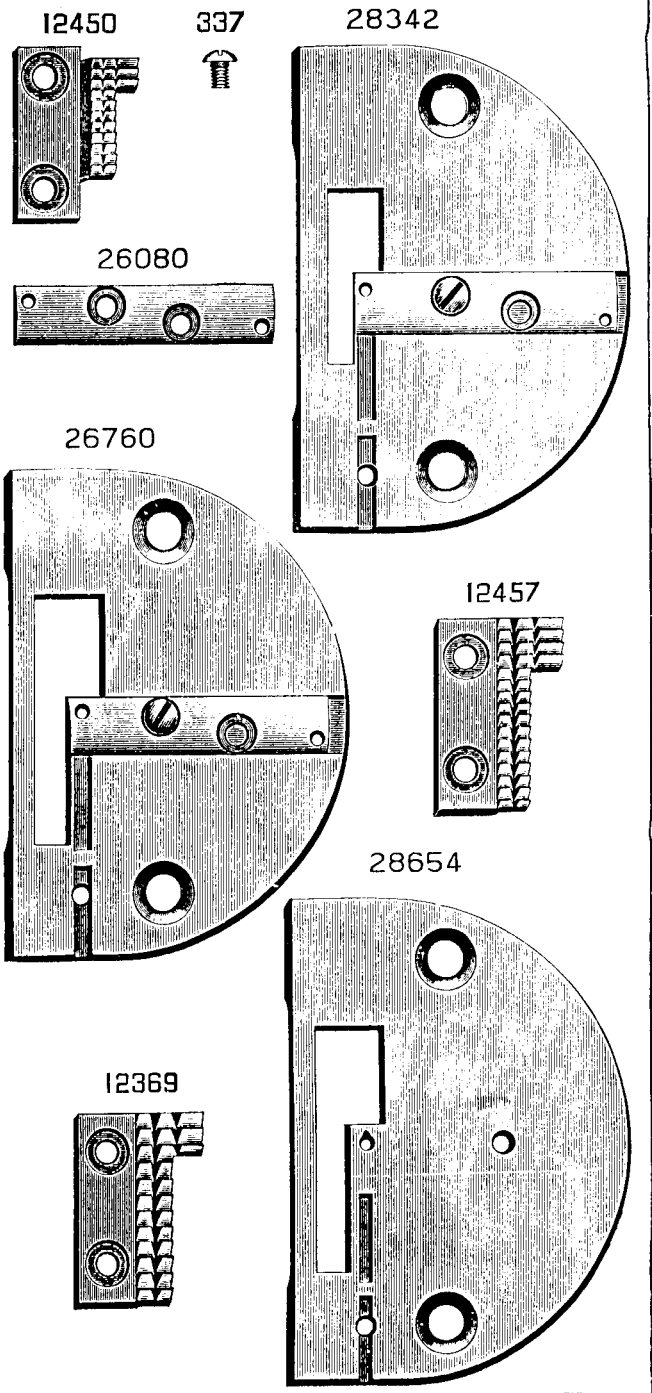
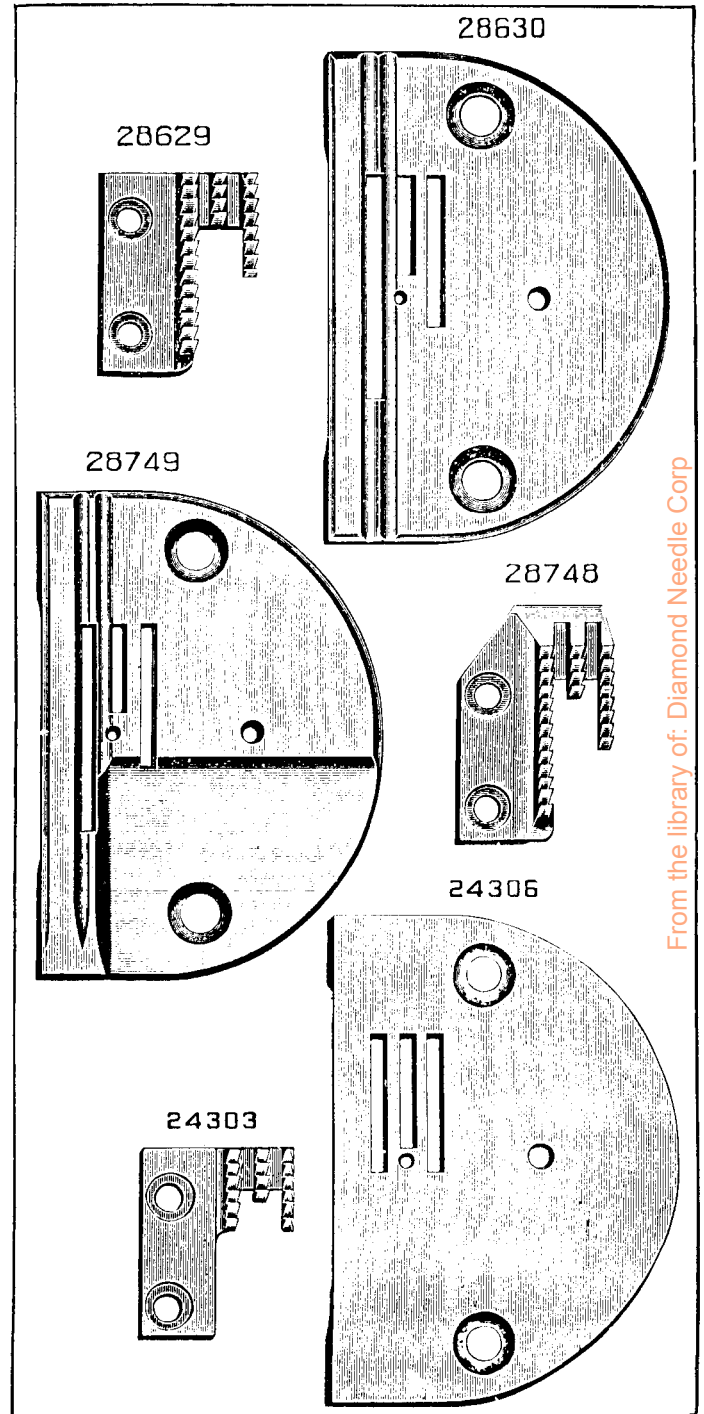


PLATE 1384—FULL SIZE



From the library of: Diamond Needle Corp

PLATE 1385—FULL SIZE

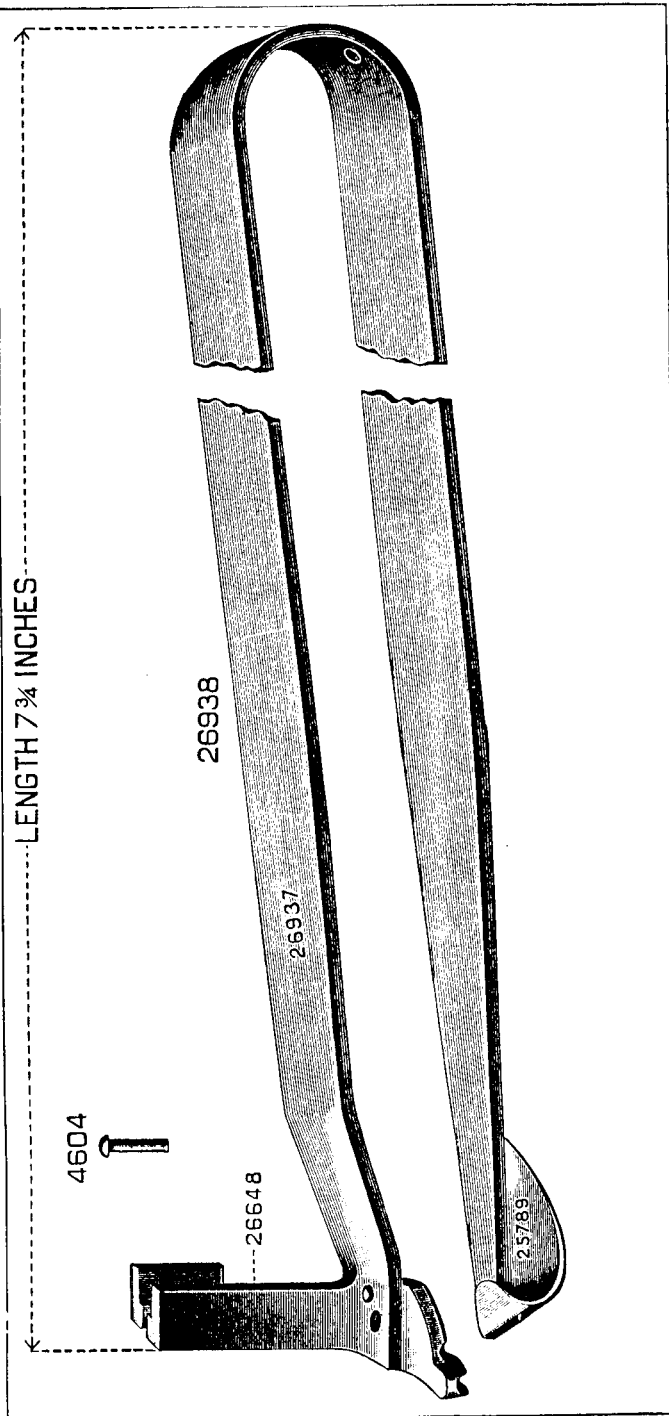


PLATE 1386—FULL SIZE

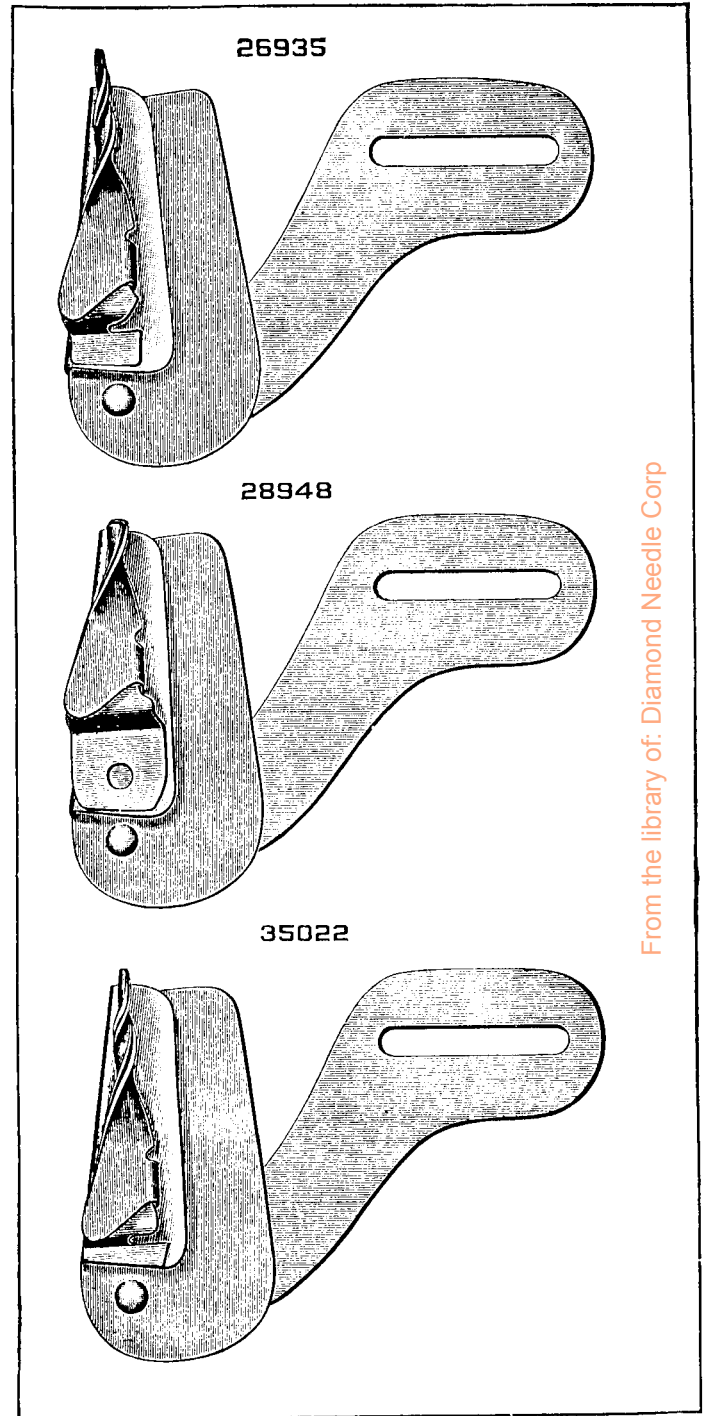


PLATE 1387—FULL SIZE

26607



26608



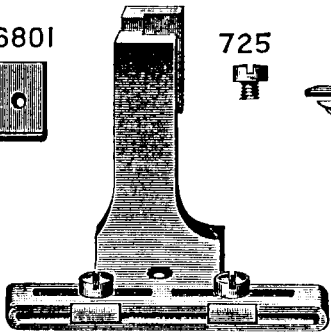
26610



26936



26802



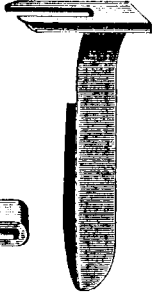
26801



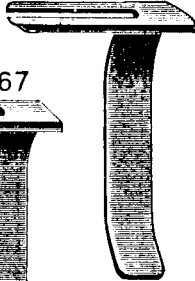
725



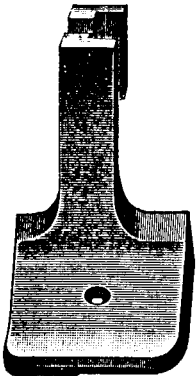
25967



26281



28849



28830

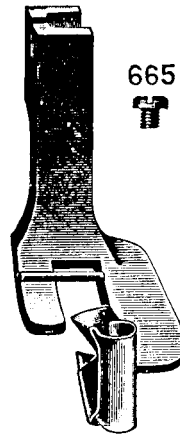


28920



PLATE 1388—FULL SIZE

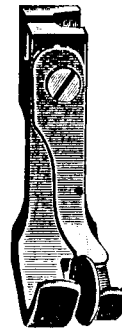
28717



665



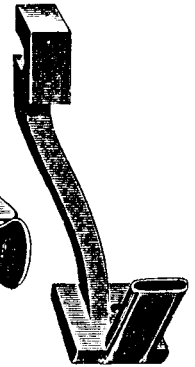
28726



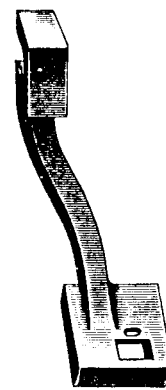
28725



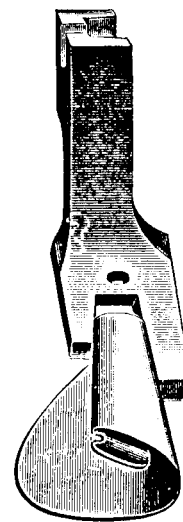
28727



28729



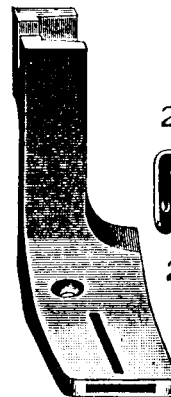
28742



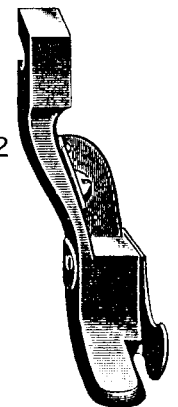
28743



28746



28773



28771



15072



28772



2113



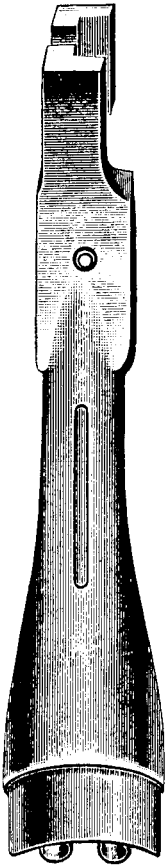
337



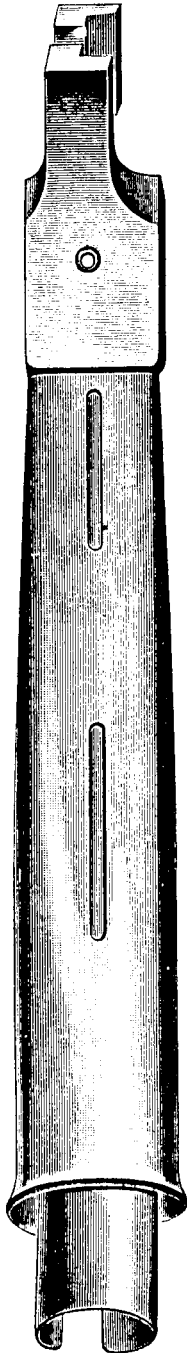
From the library of: Diamond Needle Corp

PLATE 1389—FULL SIZE

28744



28745



28747

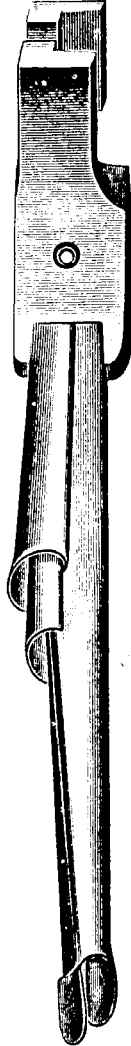
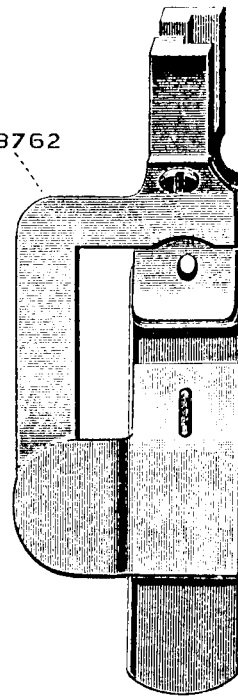


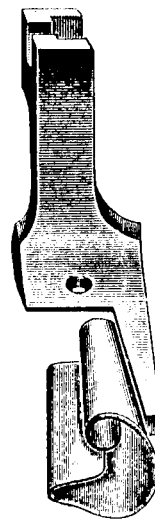
PLATE 1390—FULL SIZE

28761

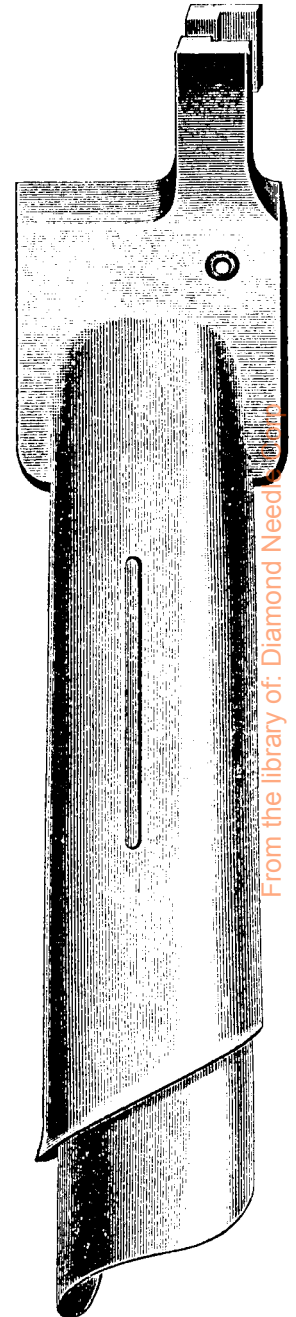


28762

28769



28768



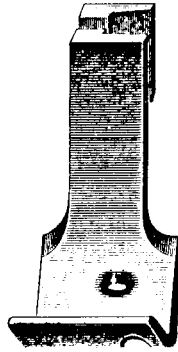
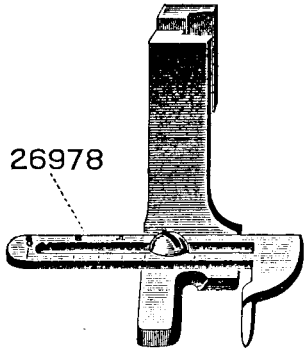
From the library of: Diamond Need

PLATE 1391—FULL SIZE

26977

28626

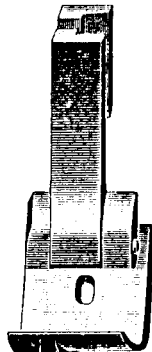
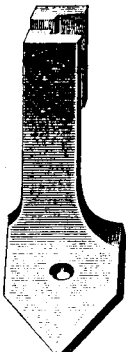
26978



28672

28675

28691



28701

28713

28715

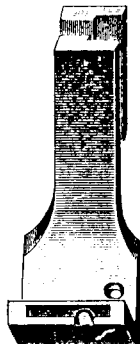
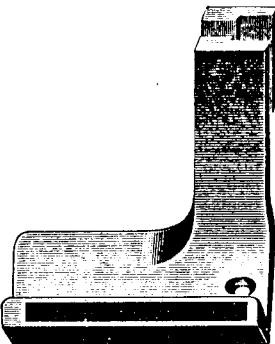
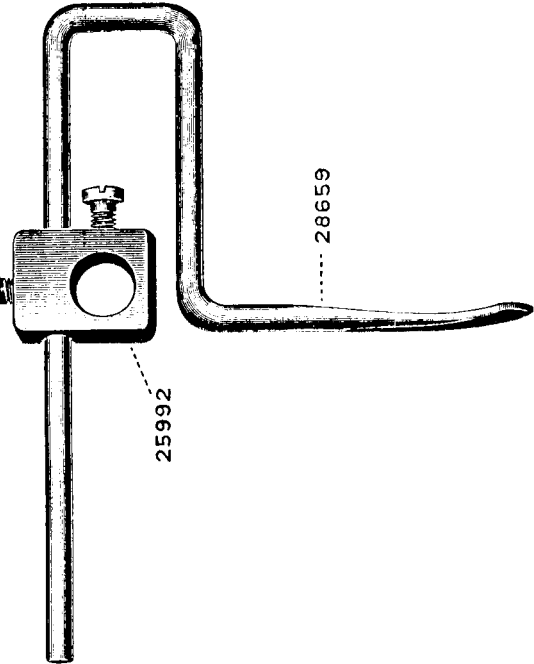


PLATE 1392—FULL SIZE

28660

25992

28659



28671

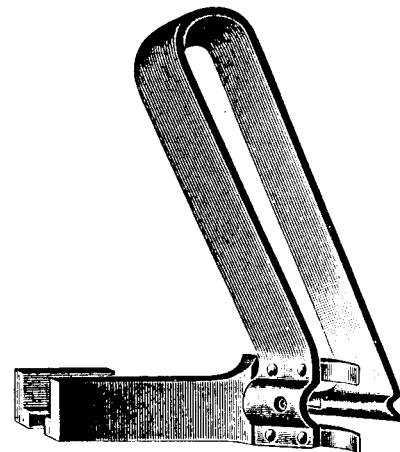
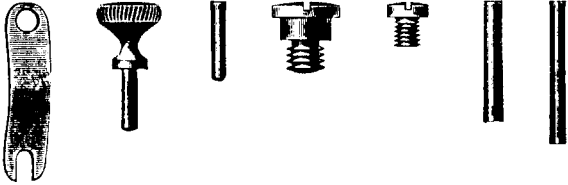


PLATE 1394—FULL SIZE

26174 26173 2273 96 228 18055 26276

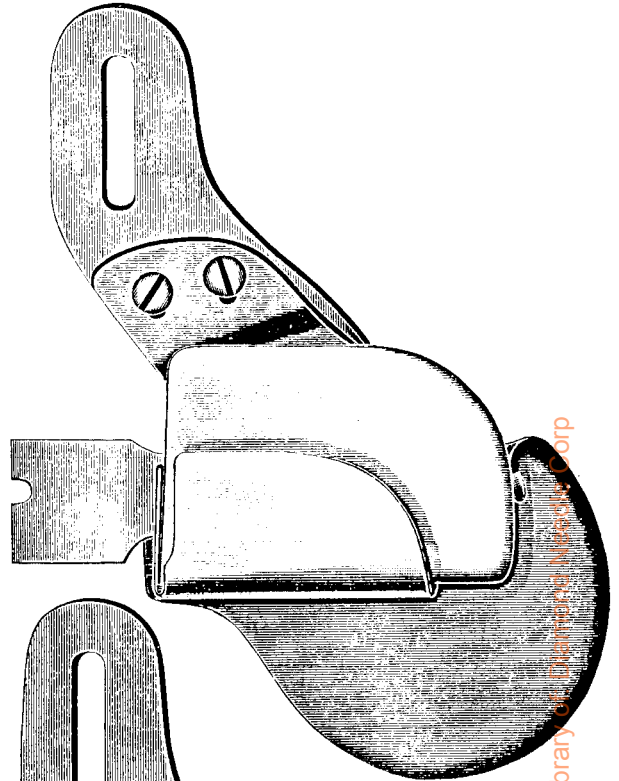


26645 26644 23219

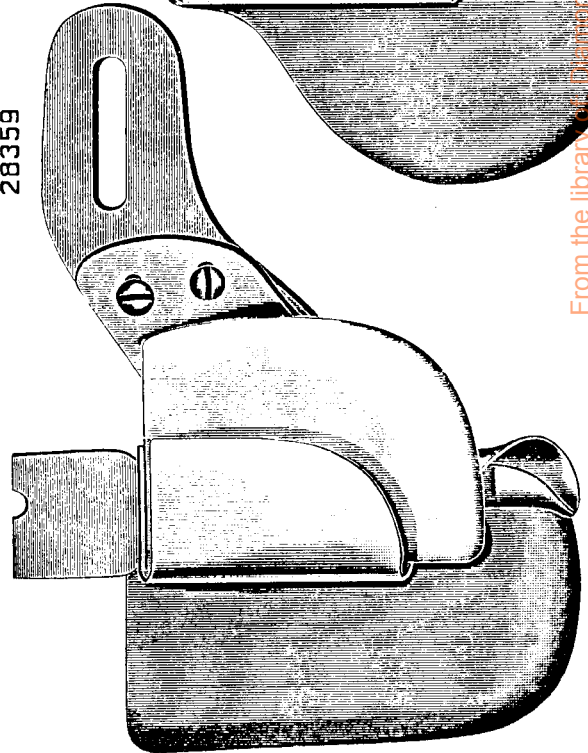


PLATE 1395—FULL SIZE

28549

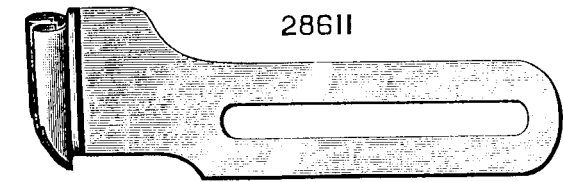


28359



From the library of www.libraryofcongress.gov

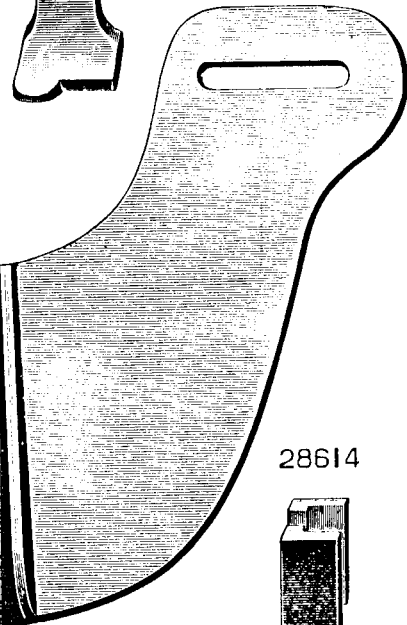
PLATE 1396—FULL SIZE



28612



28613



28614

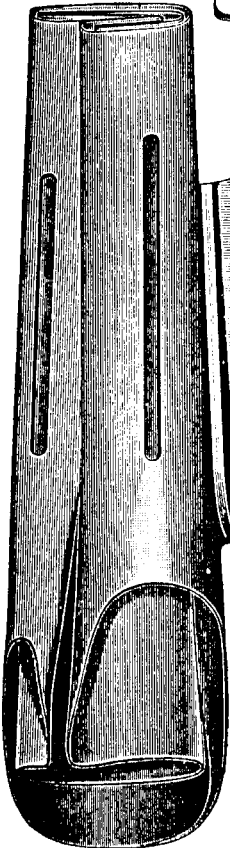
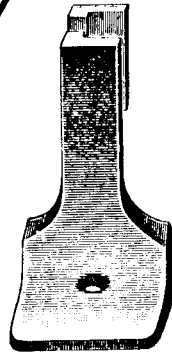
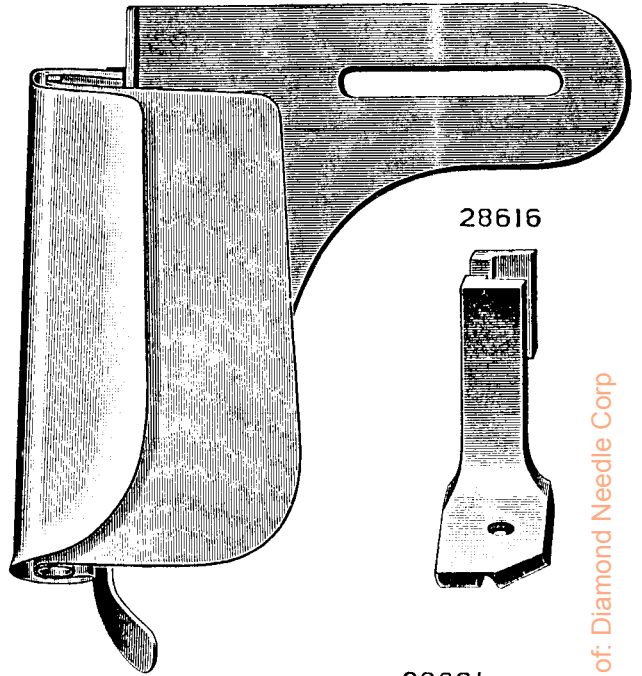
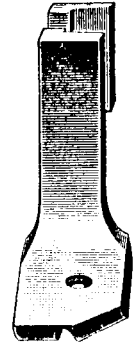


PLATE 1397—FULL SIZE

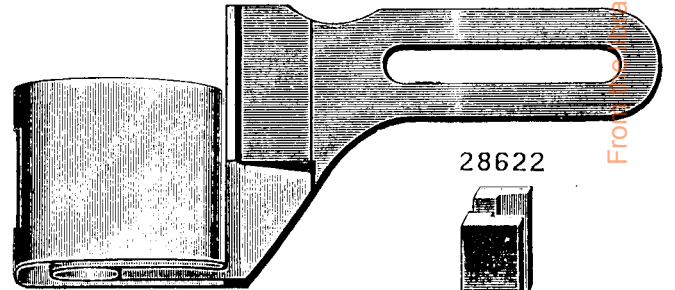
28615



28616



28621



28622

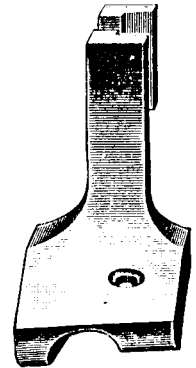
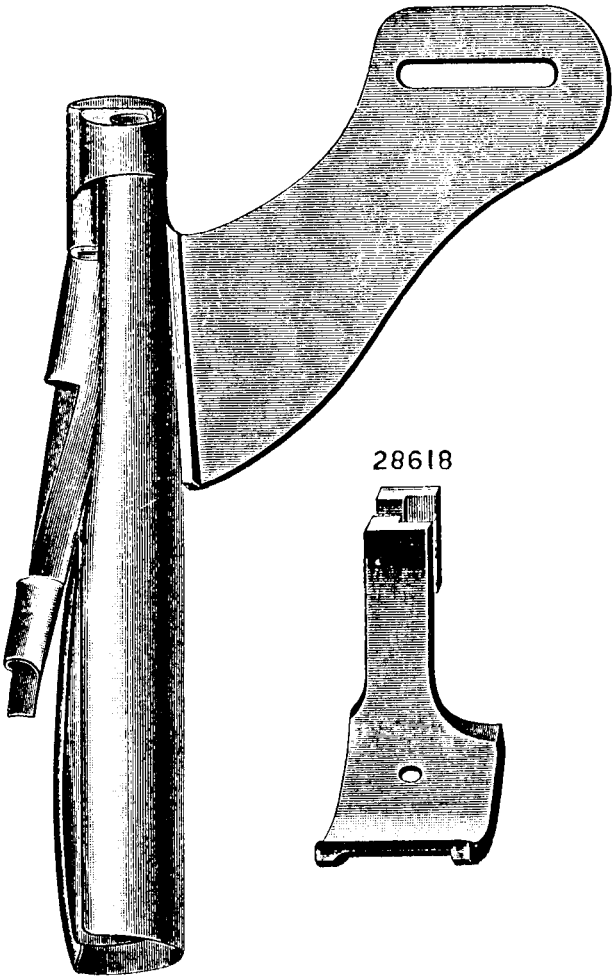
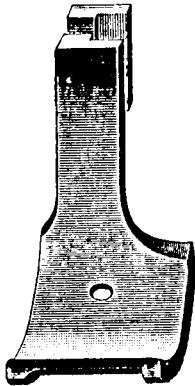


PLATE 1398—FULL SIZE

28617



28618



28635

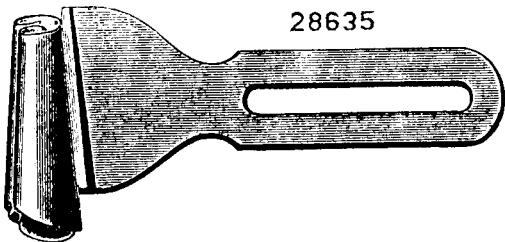
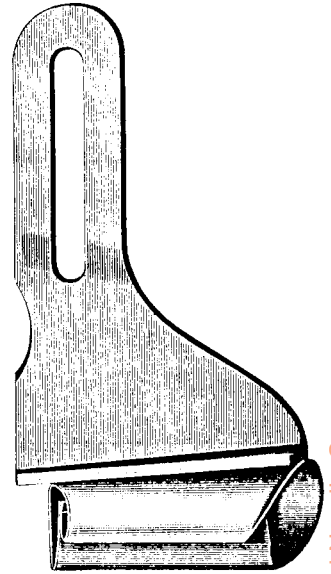
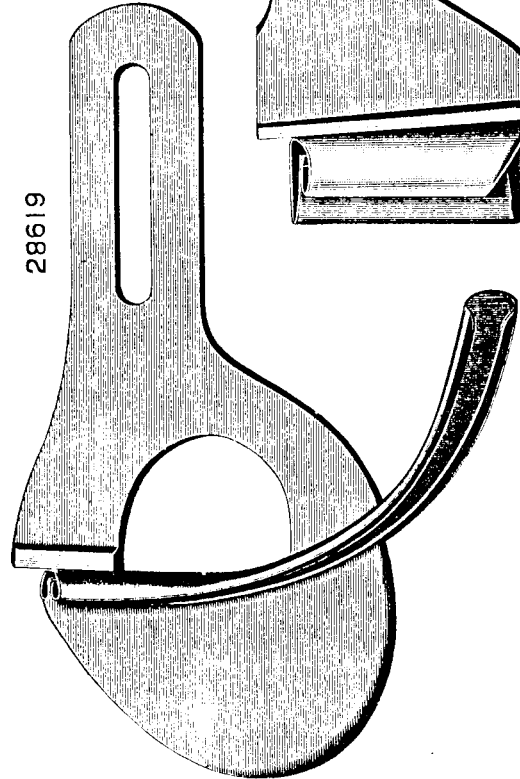


PLATE 1399—FULL SIZE

28633



28619



28620



PLATE 1971—ONE-HALF SIZE

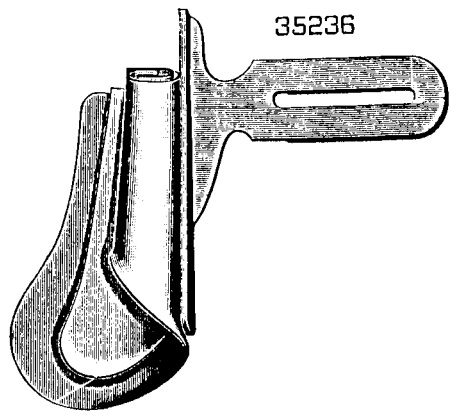
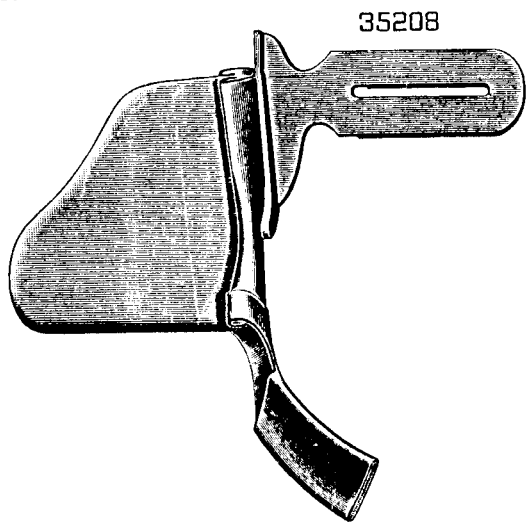
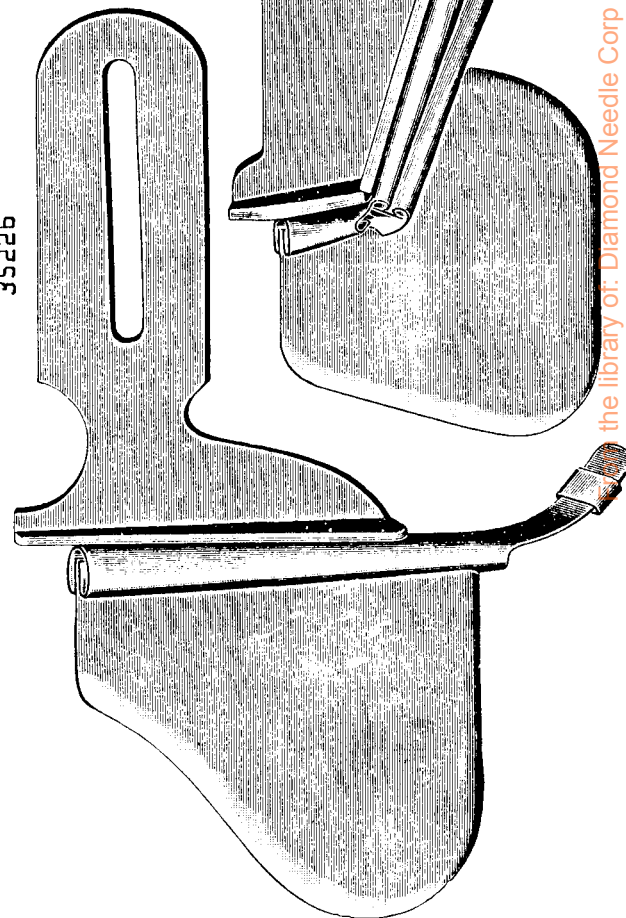
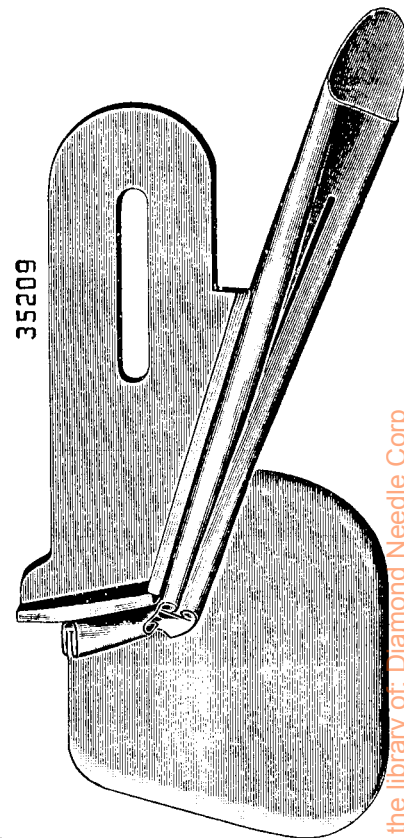


PLATE 1972—FULL SIZE

35226



35209



the library of: Diamond Needle Corp

PLATE 2003—ONE-HALF SIZE

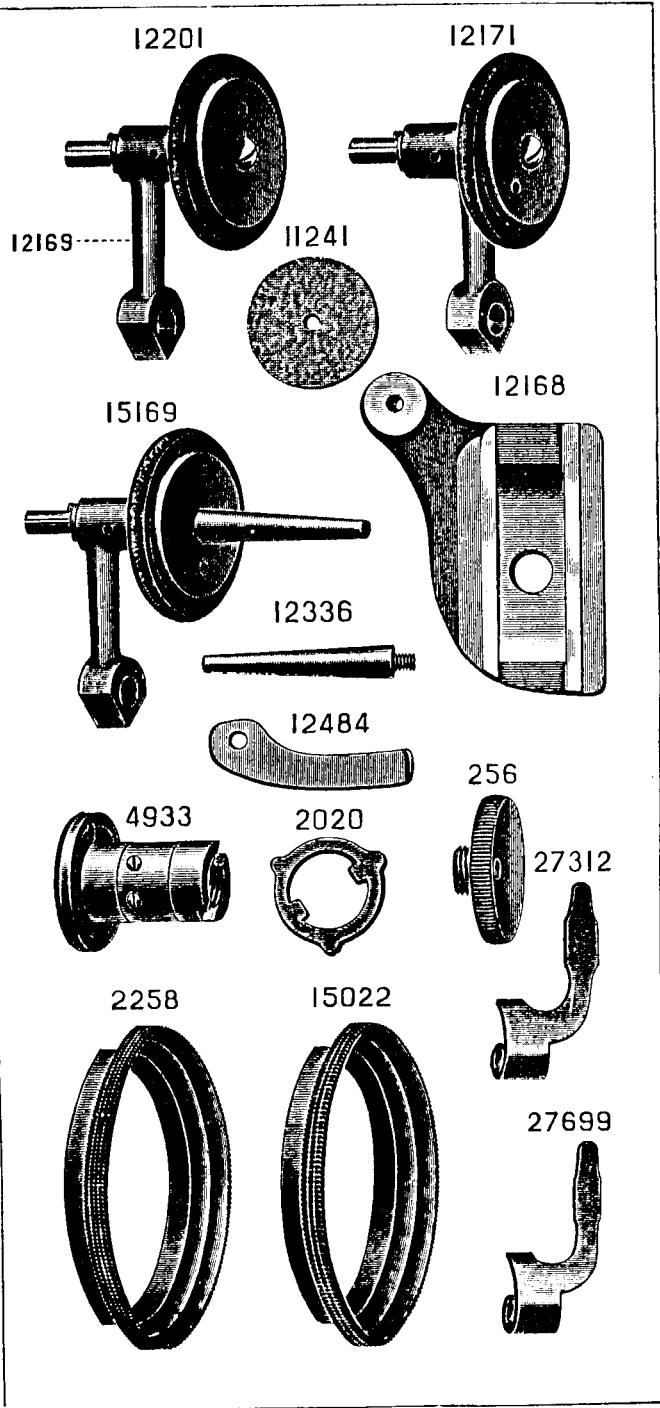
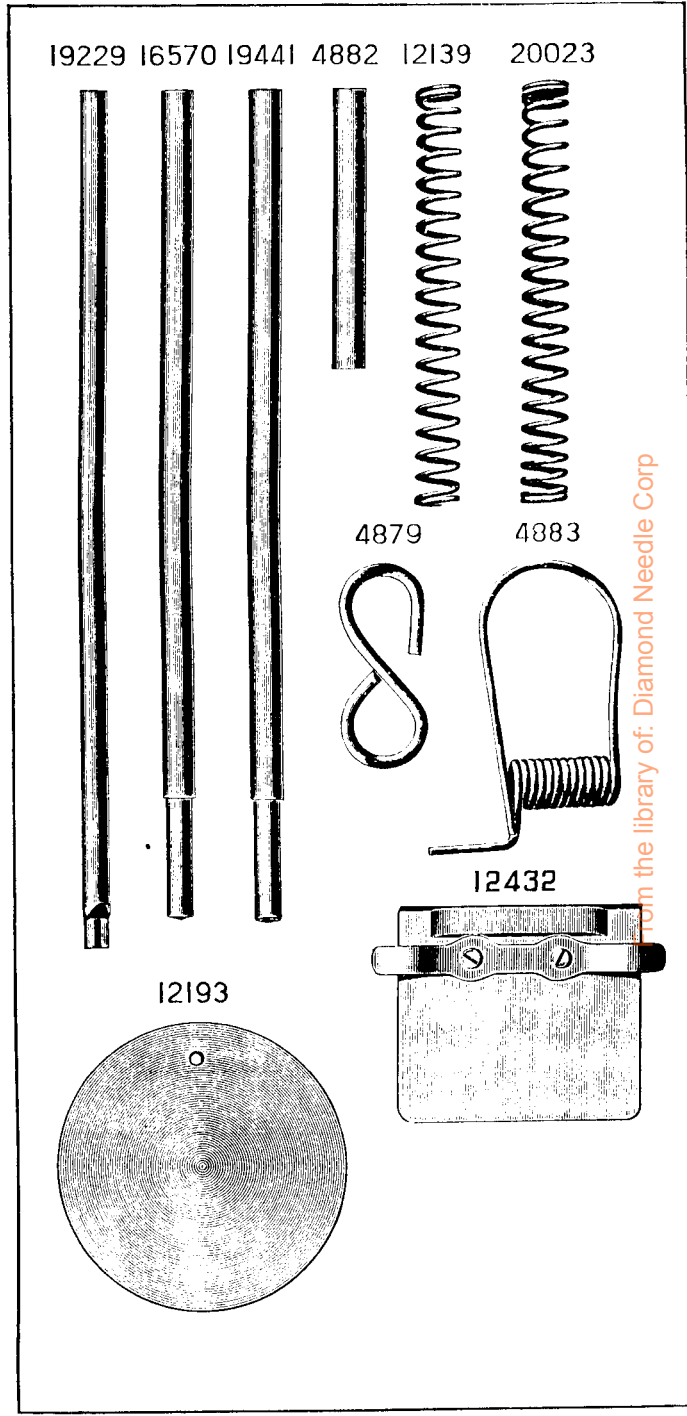


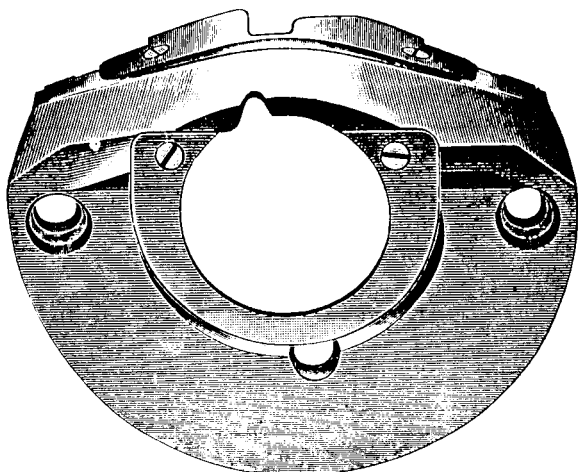
PLATE 2004—ONE-HALF SIZE



From the library of: Diamond Needle Corp

PLATE 2006—FULL SIZE

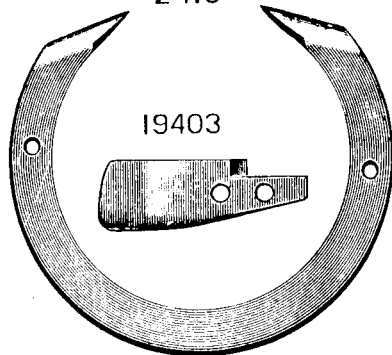
24120



24009

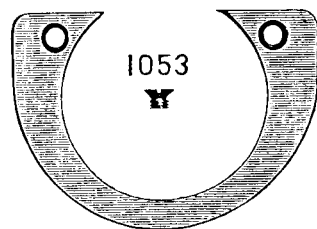


2419



19403

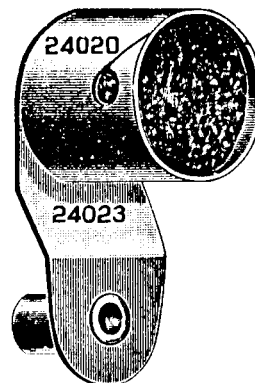
24117



1053

PLATE 2009—FULL SIZE

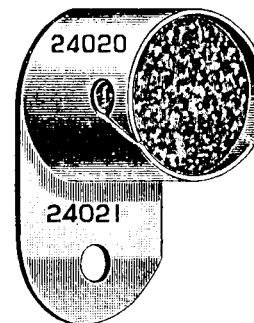
24024



24020

24023

20261



24020

24021

213



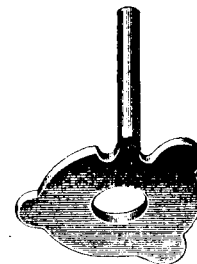
24075



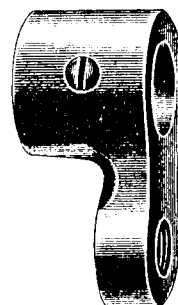
362



20037



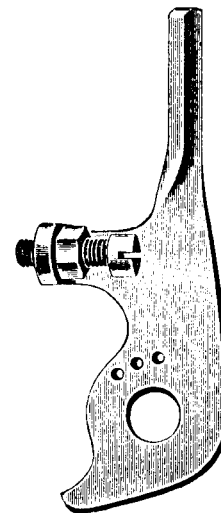
16556



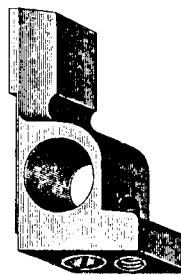
25143



19258



43917



1128

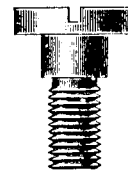


PLATE 2012—FULL SIZE

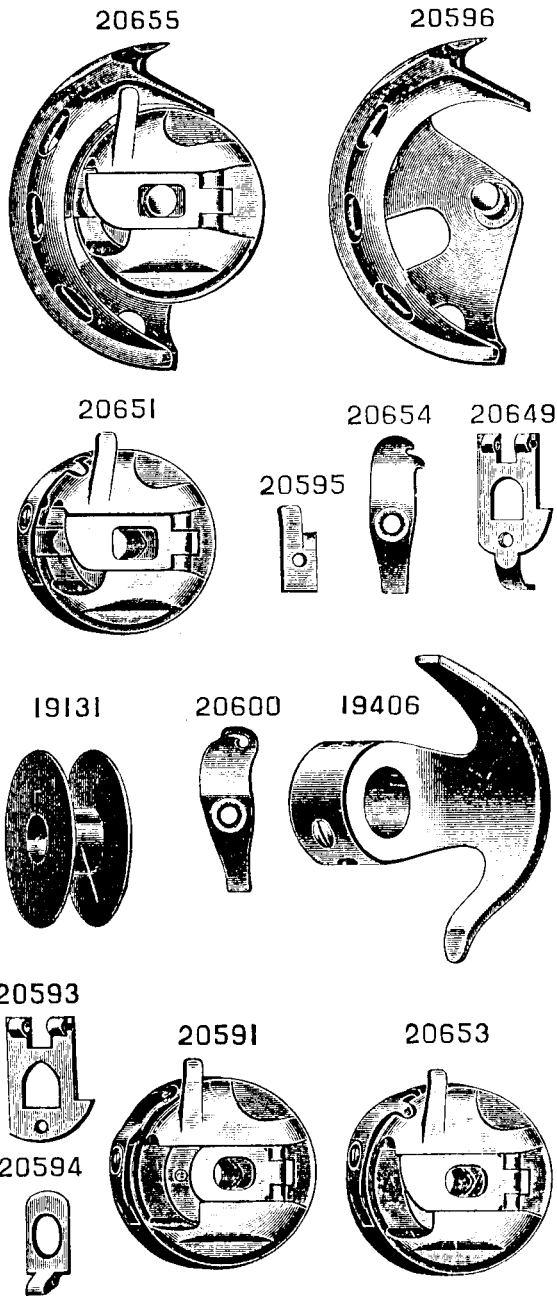


PLATE 2014—FULL SIZE

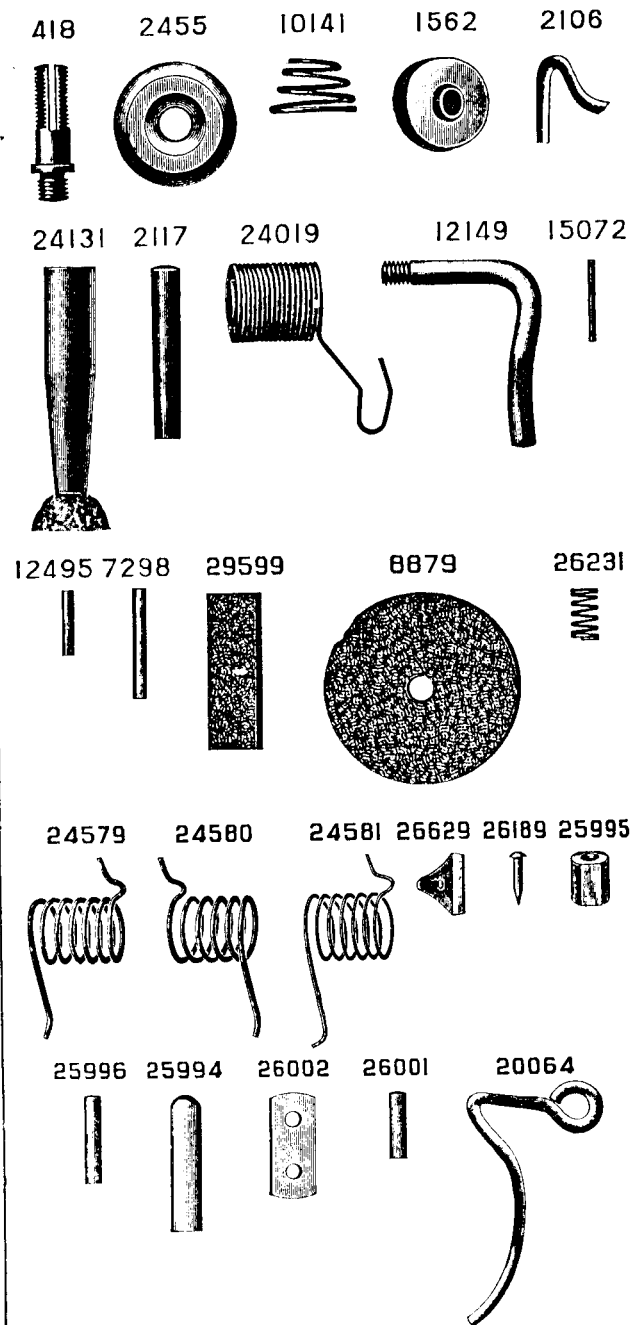
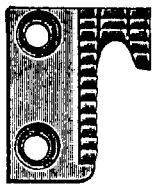
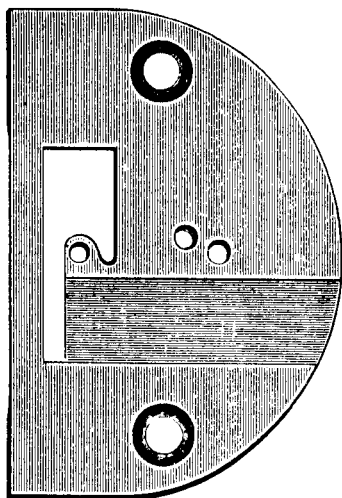


PLATE 2021—FULL SIZE

12425



26249



25983



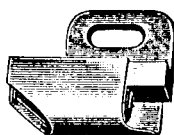
207



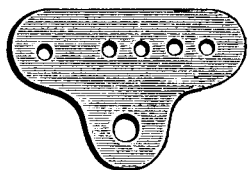
7071



25721



26616



26615 26614



25722

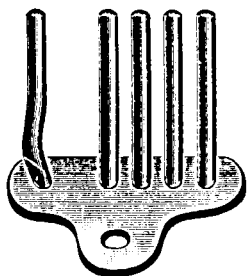
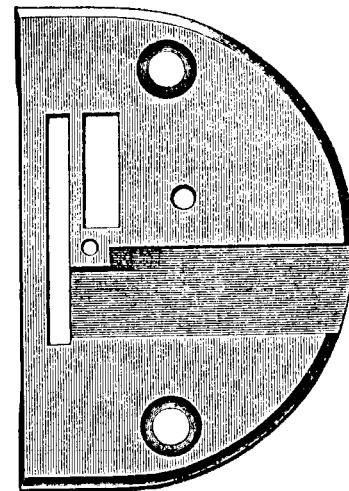
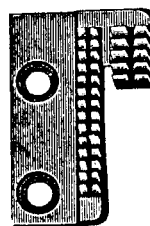


PLATE 2022—FULL SIZE

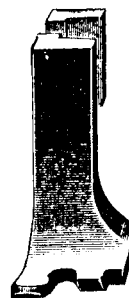
26401



19474



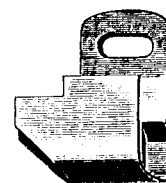
26400



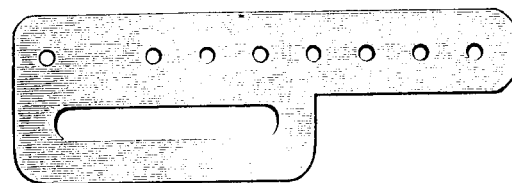
26617 26486



25733



26618



25734

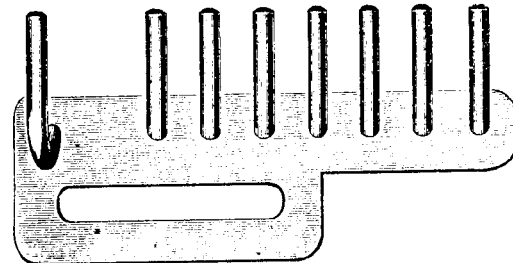
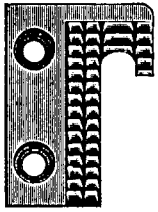


PLATE 2023—FULL SIZE

12370



26465

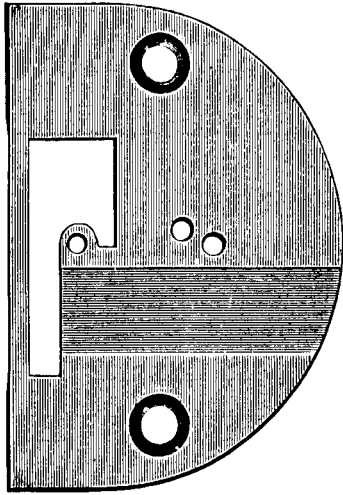
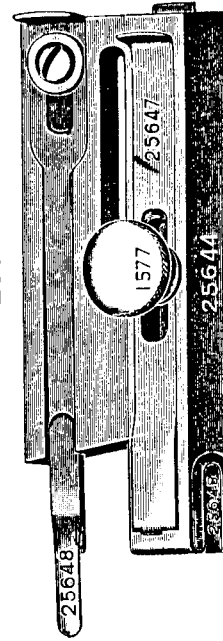
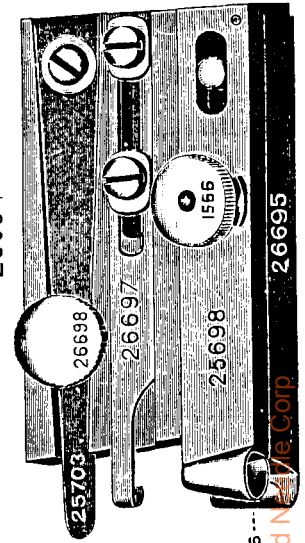


PLATE 2024—FULL SIZE

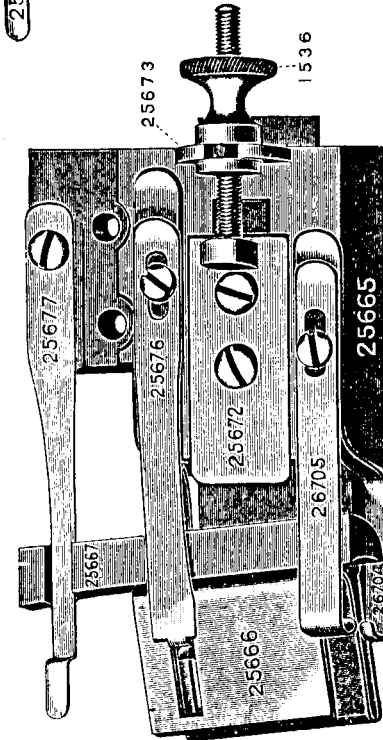
25650



26694



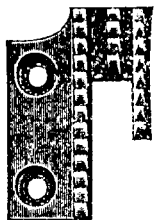
25678



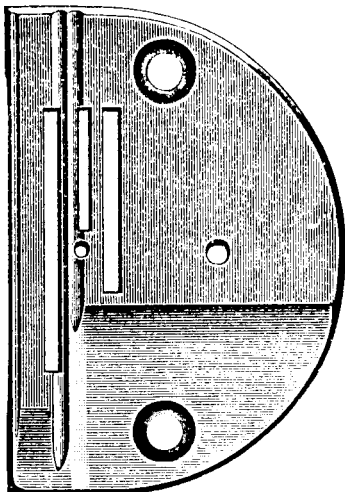
26696...
From the library of: Diamond N
The Corp.

PLATE 2025—FULL SIZE

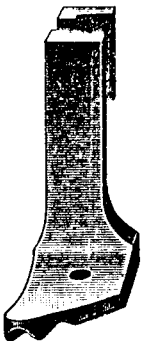
26166



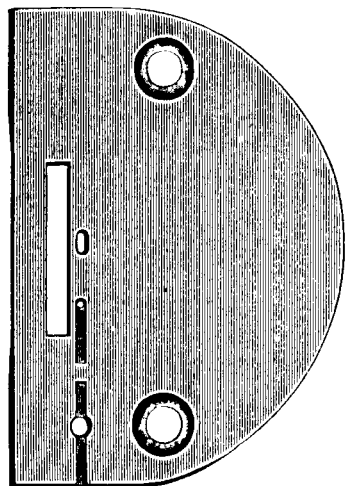
26168



26167



26381



25984



12436

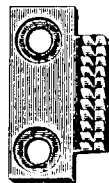


PLATE 2026—FULL SIZE

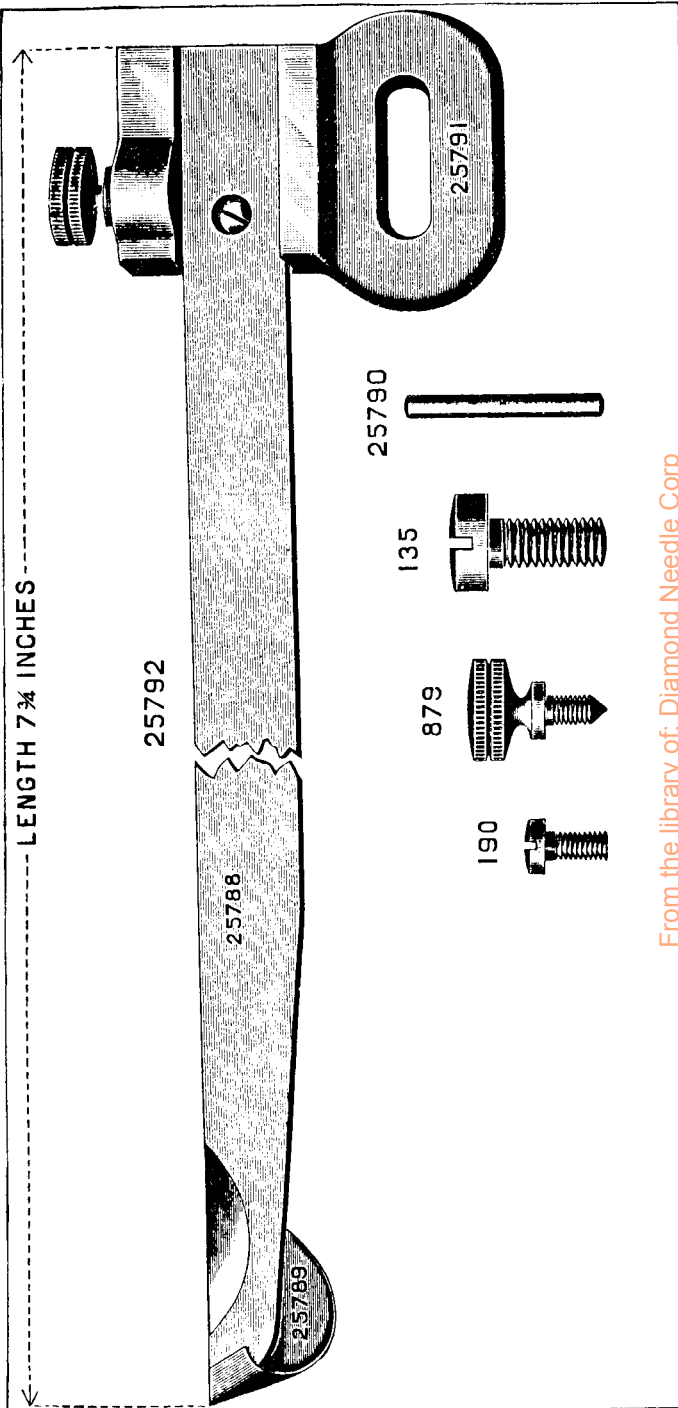
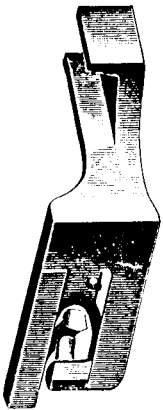
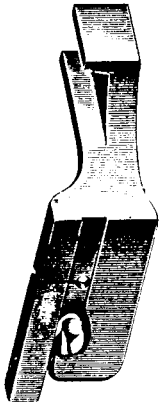


PLATE 2028—FULL SIZE

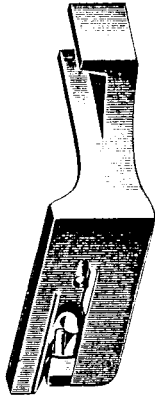
25922



26161



26428



25920



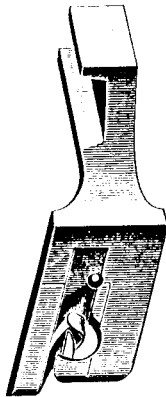
6267



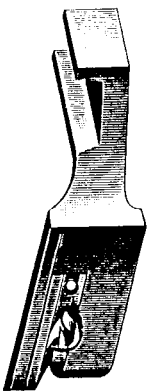
25888



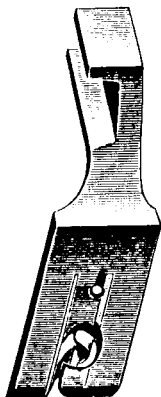
28661



28663



28741



28662

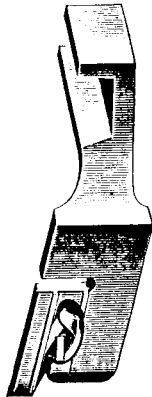
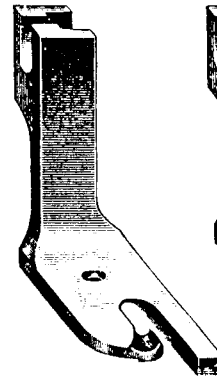
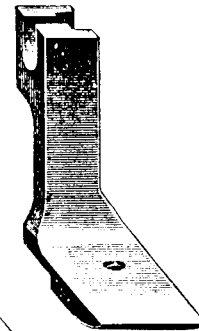


PLATE 2029—FULL SIZE

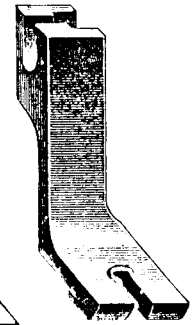
26403



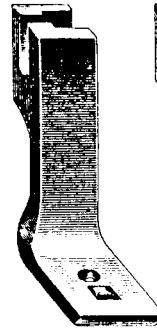
25985



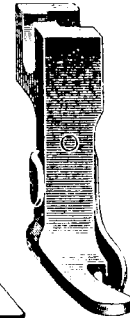
26638



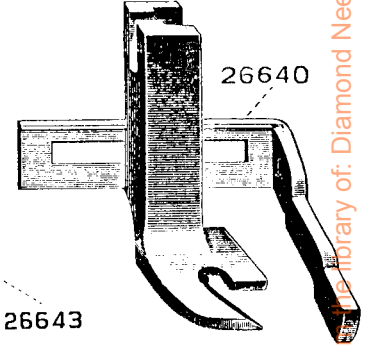
26650



26646



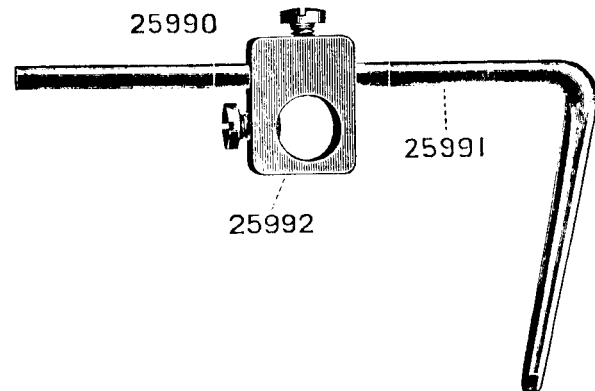
26641



26640

26643

25990



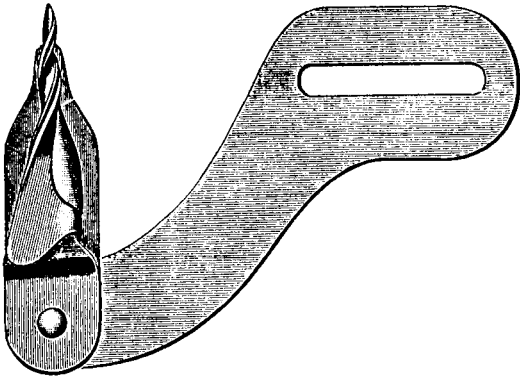
25991

25992

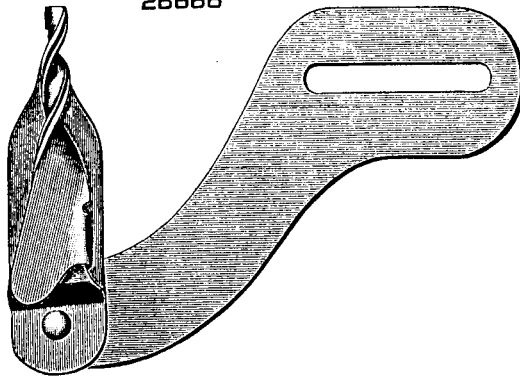
From the Library of: Diamond Needle Corp

PLATE 2030—FULL SIZE

26664



26666



26656

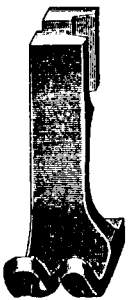
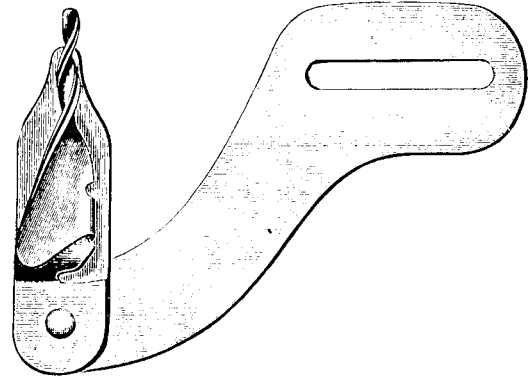
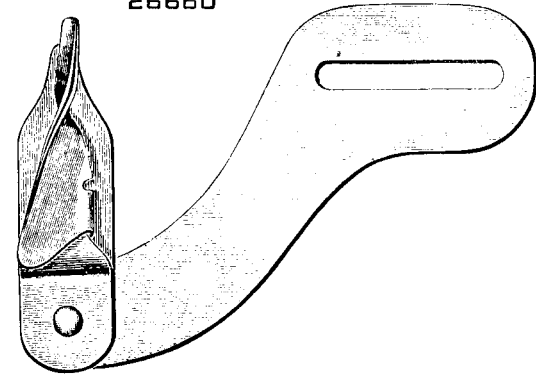


PLATE 2031—FULL SIZE

26655



26660



26662

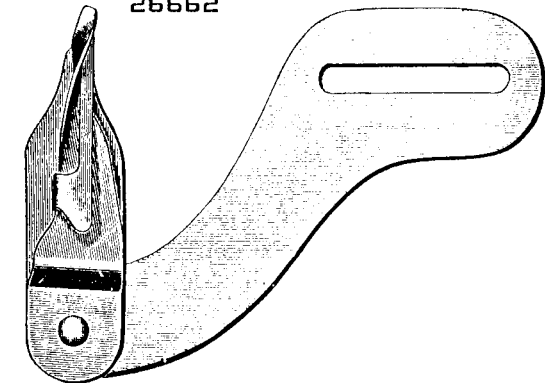
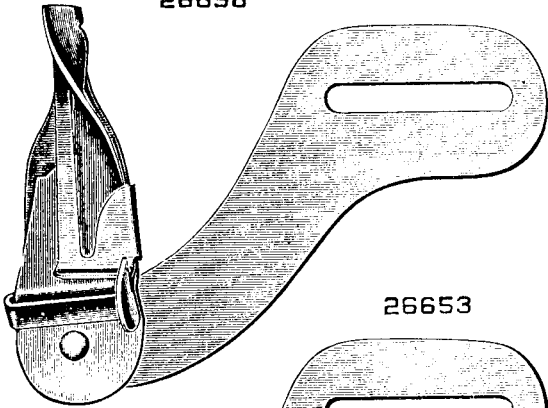
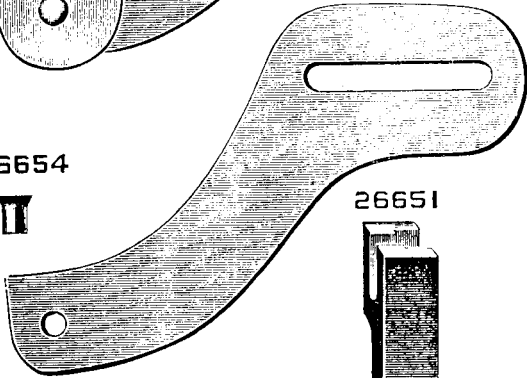


PLATE 2032—FULL SIZE

26658



26653



26654



26651

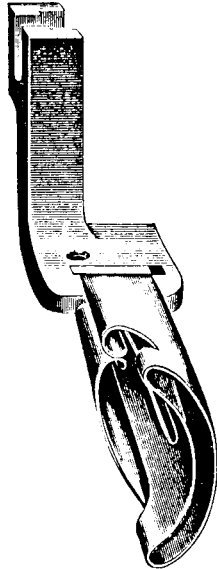
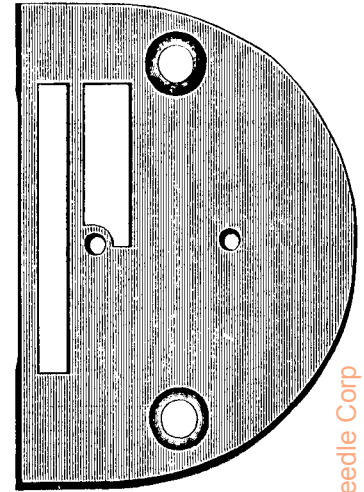
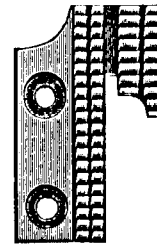


PLATE 2033—FULL SIZE

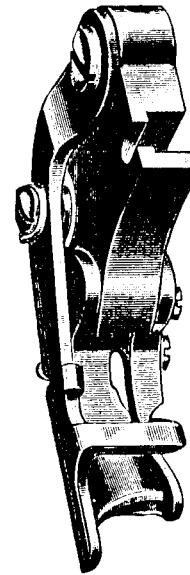
26605



26603



26604



28360

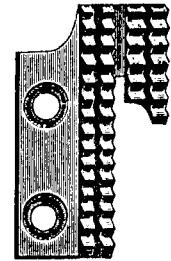


PLATE 2034—FULL SIZE

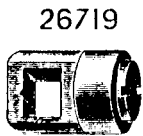
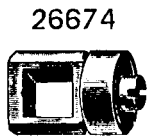
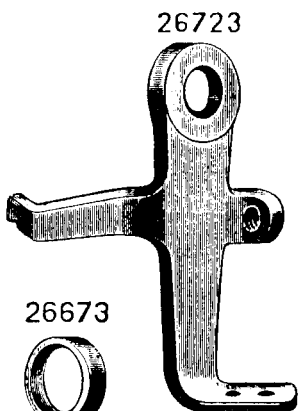
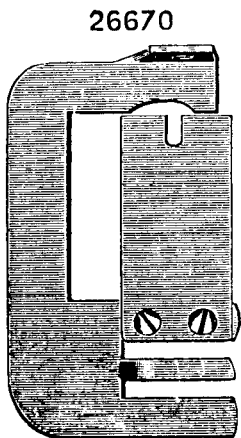
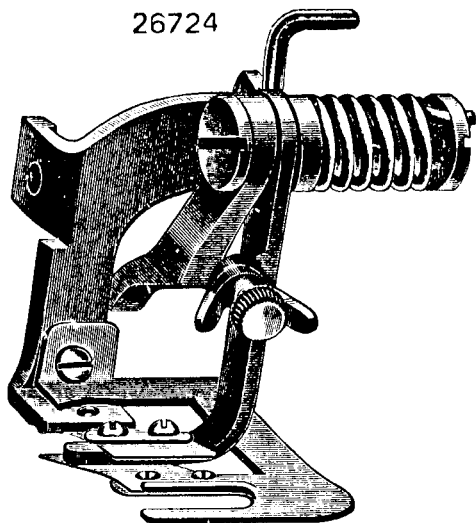
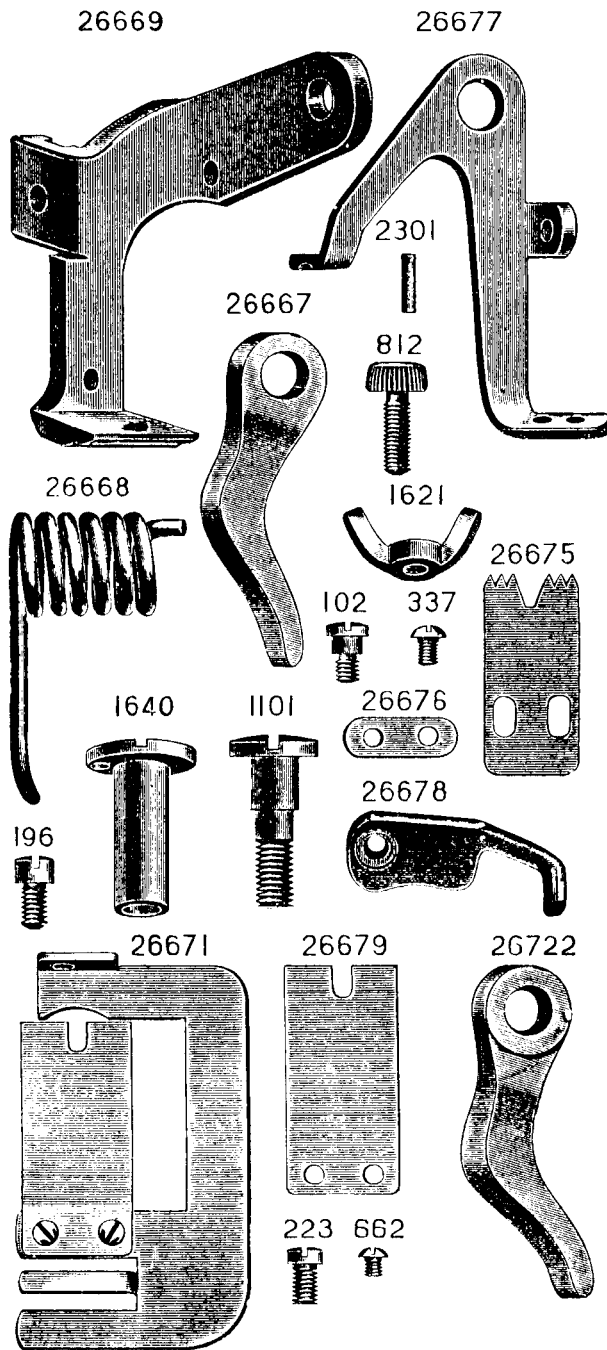


PLATE 2035—FULL SIZE



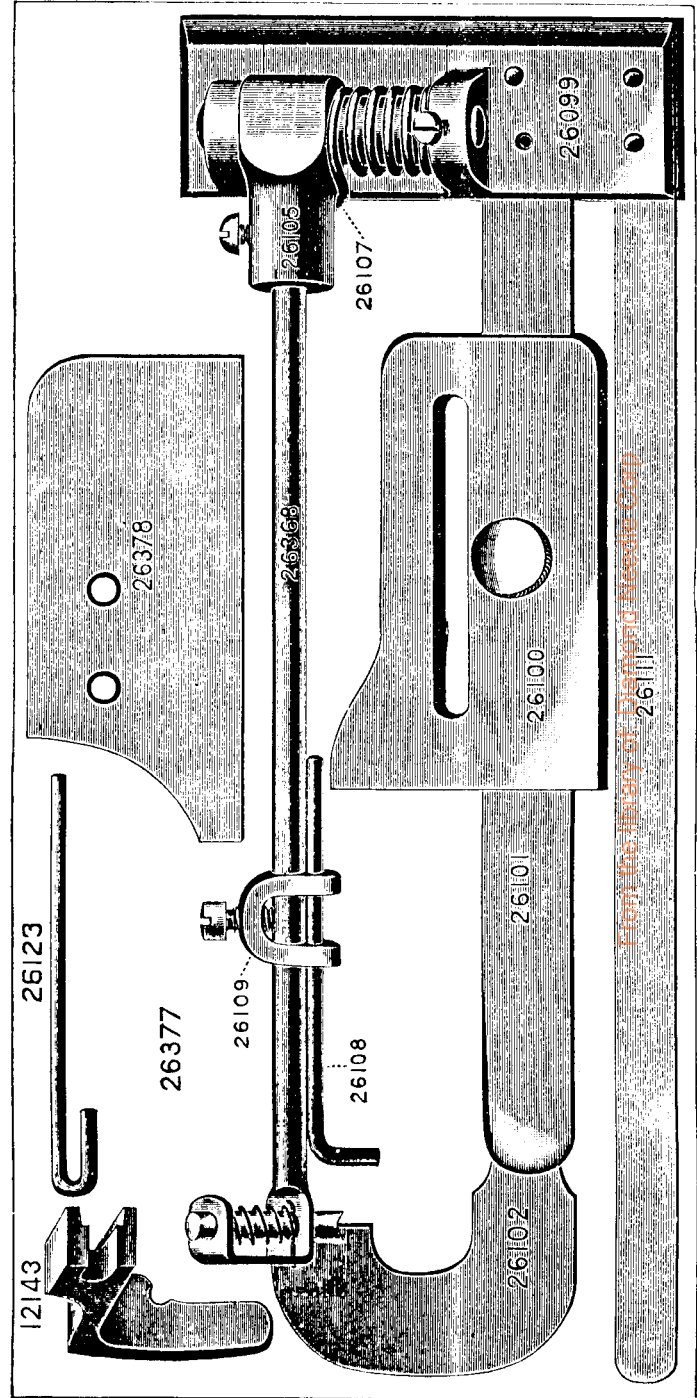
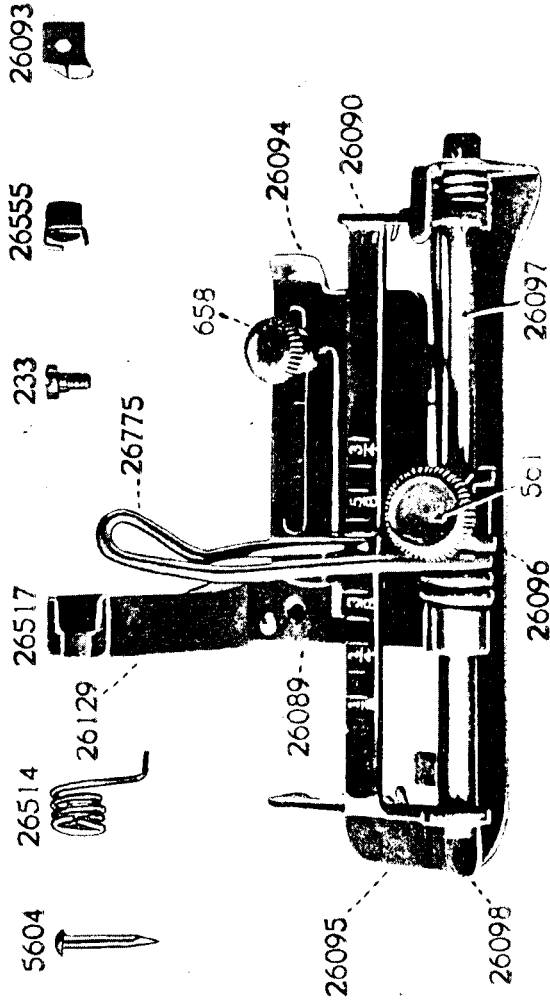


PLATE 2038—FULL SIZE

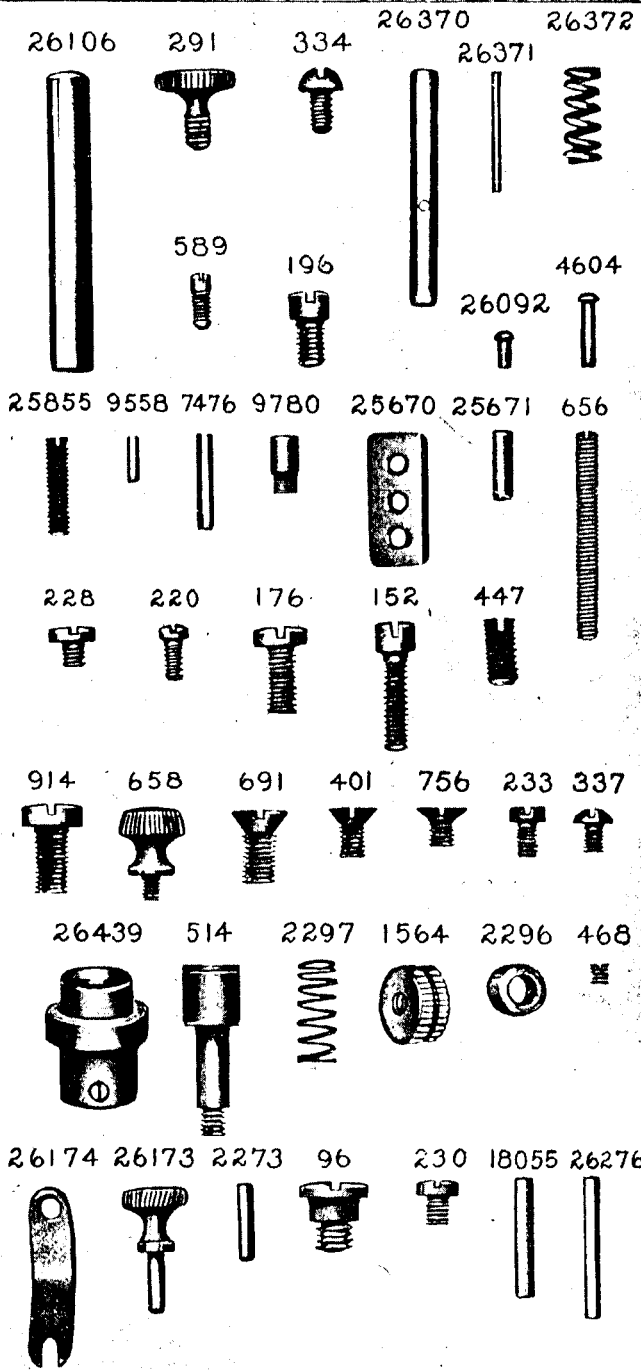
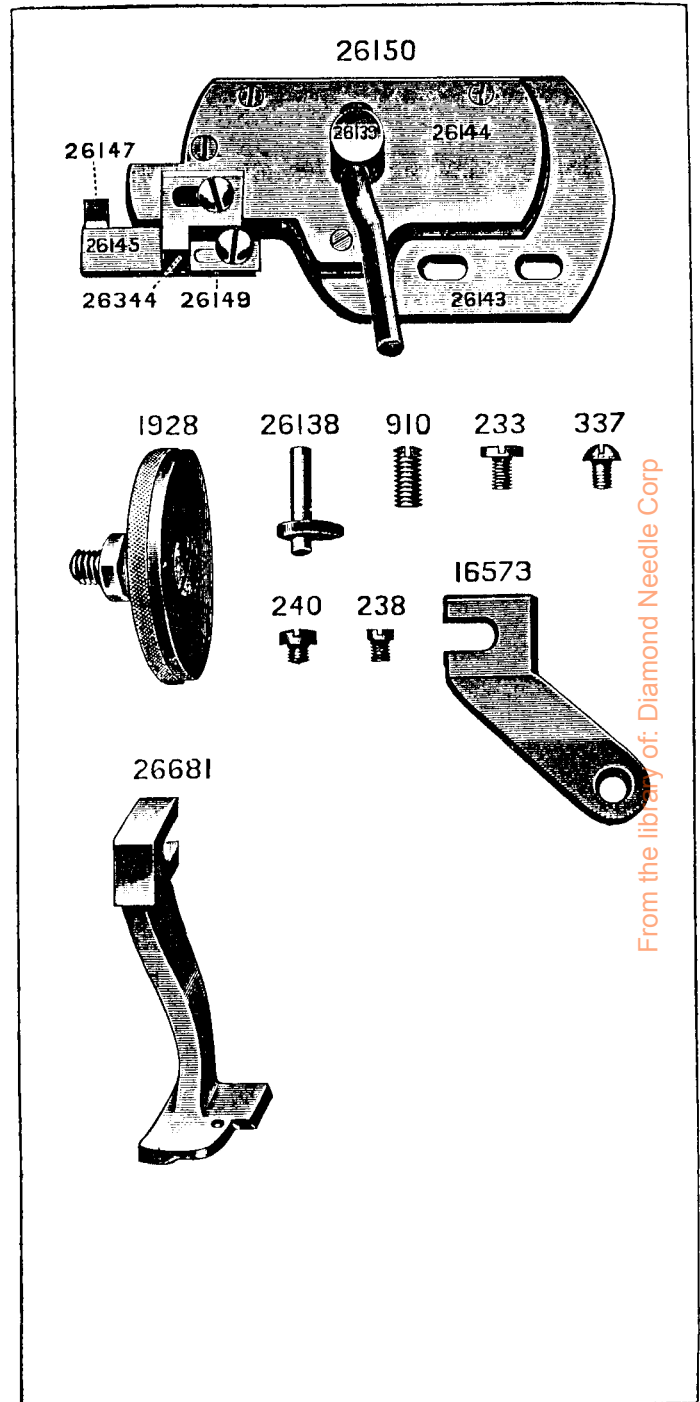


PLATE 2039—FULL SIZE



From the library of: Diamond Needle Corp

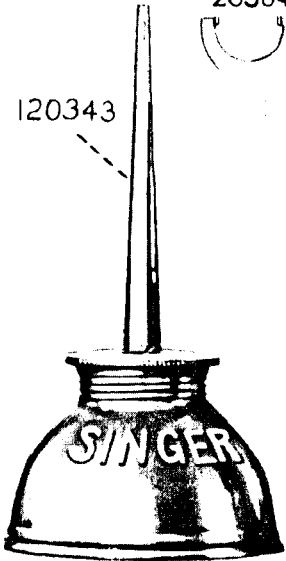
PLATE 2045—ONE-HALF SIZE

26026



120342

120343



20364



26485



22003



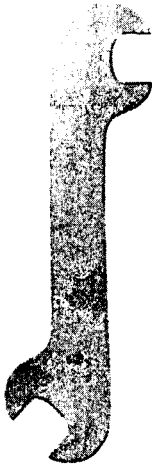
4822



35018



19221



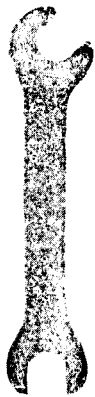
8909



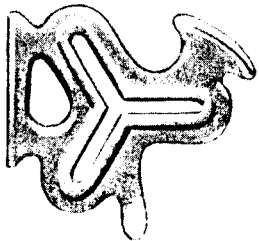
20461



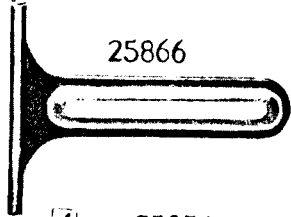
8908



25873



25866



25874

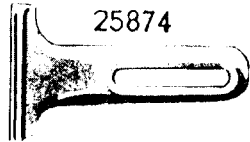
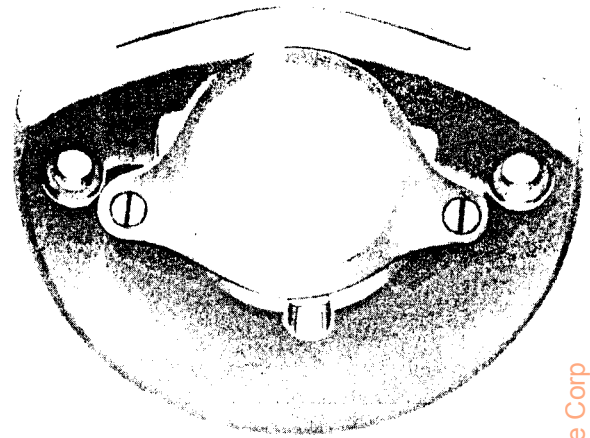
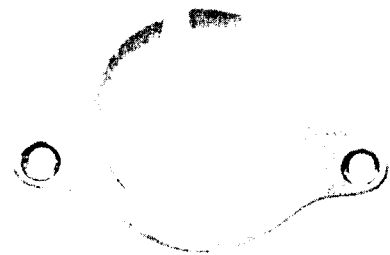


PLATE 2046—FULL SIZE

24325



24323



24009



19406

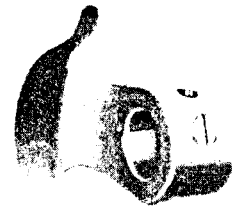
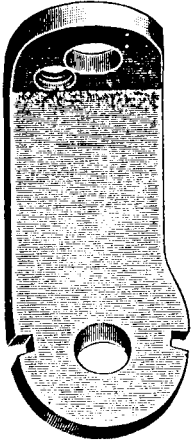
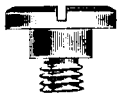


PLATE 2061—FULL SIZE

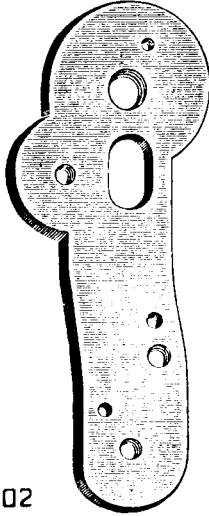
35273



76



35272



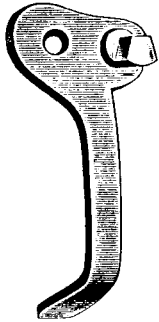
337



35275



35274



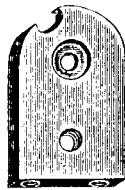
108



102



35276



10135



239



14026



4604



35277

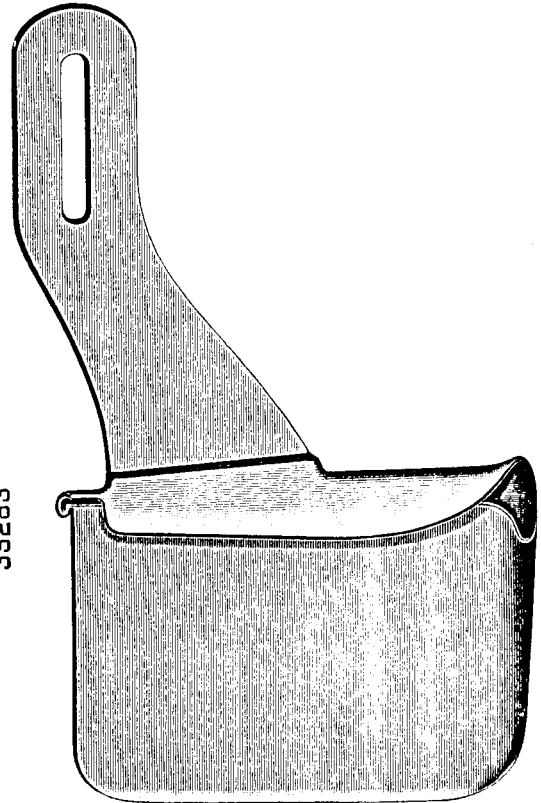


217

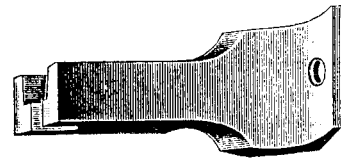


PLATE 2062—FULL SIZE

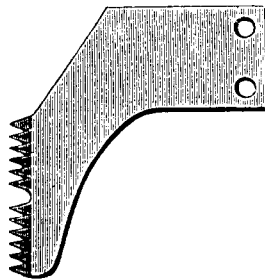
35283



35285



35286



35279

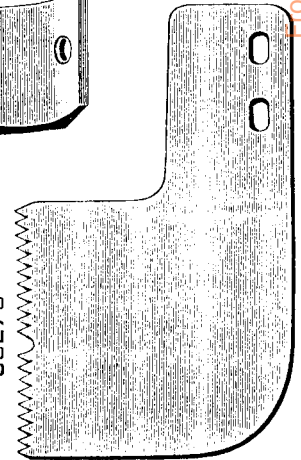
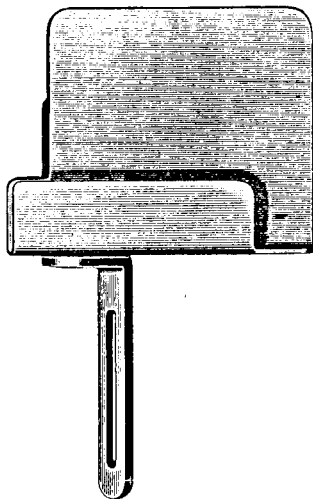


PLATE 2064—FULL SIZE

35282



35284

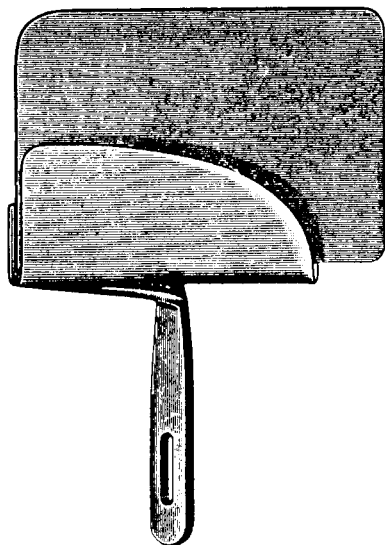
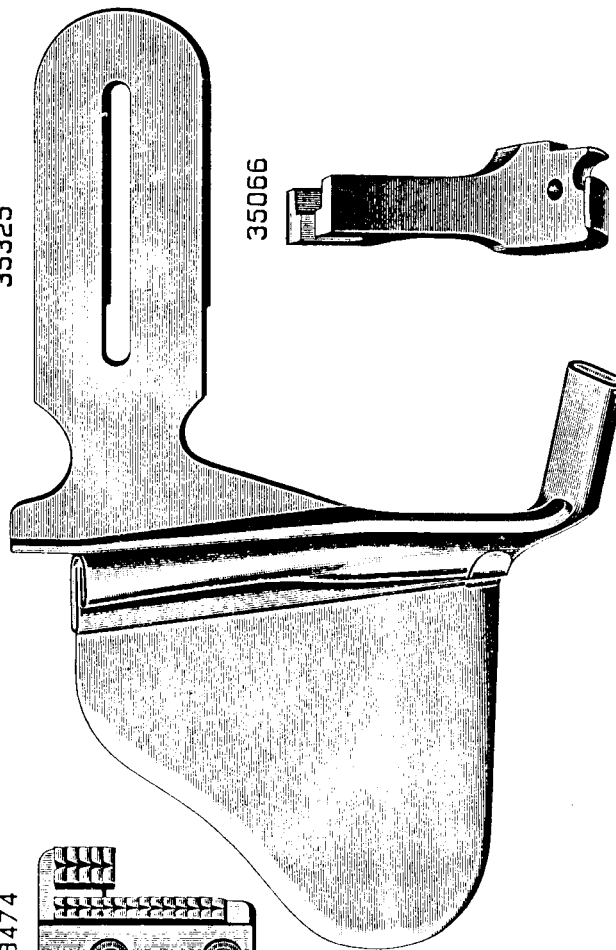
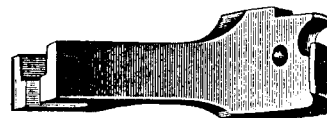


PLATE 2067—FULL SIZE

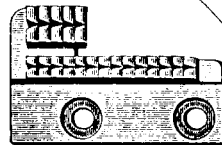
35325



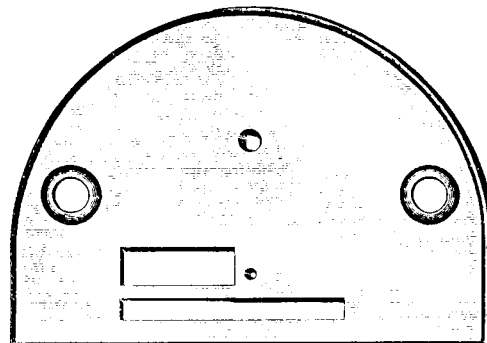
35066



19474



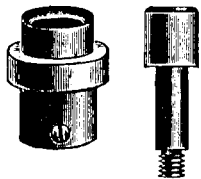
24572



From the library of: Diamond Needle Corp

PLATE 2442—FULL SIZE

26439 514 2297 1564 2296 468



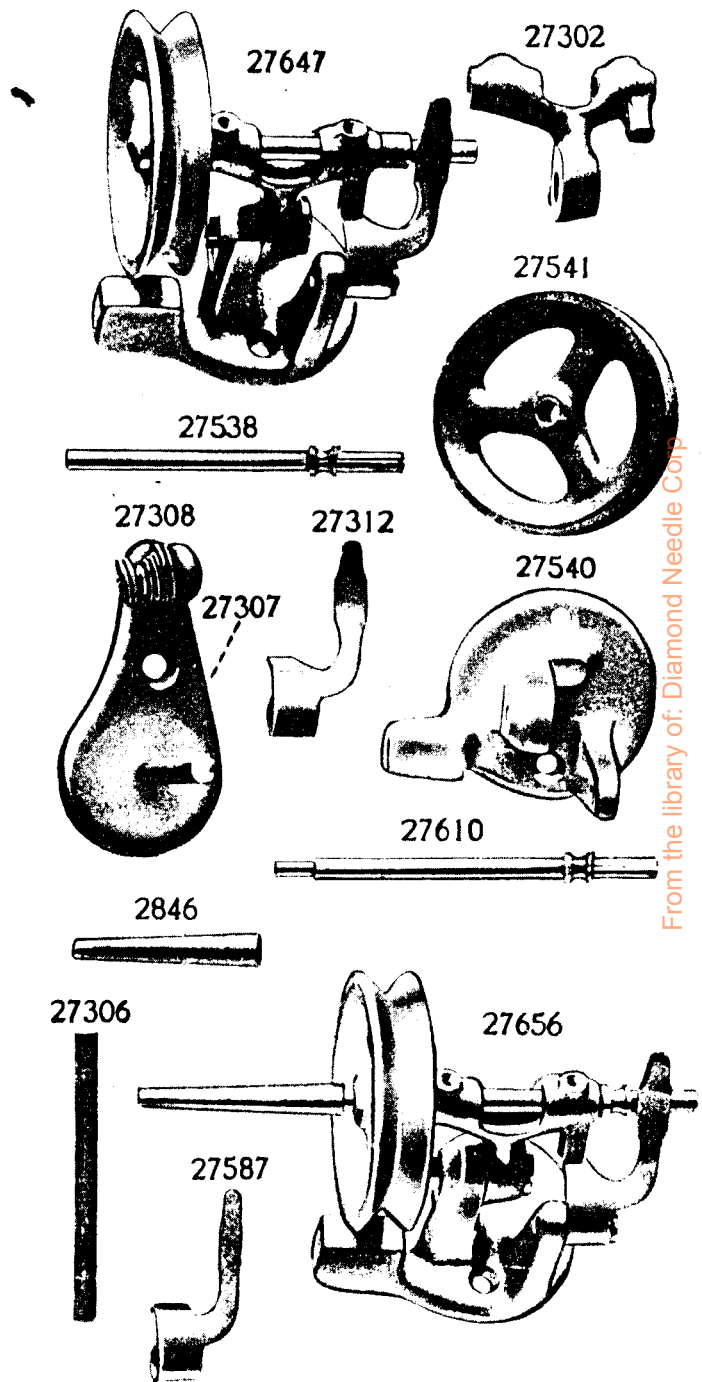
914 658 691 401 756 233 337



7476 2301 4621



PLATE 2445—ONE-HALF SIZE



From the library of: Diamond Needle Corp.

PLATE 2551—ONE-HALF SIZE

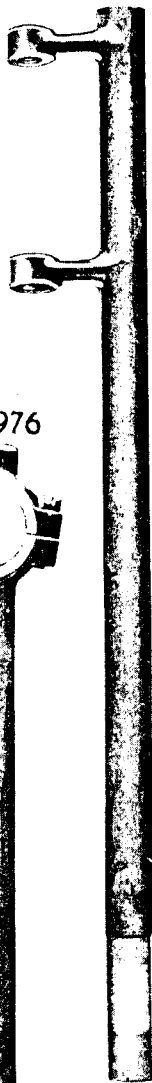
24969



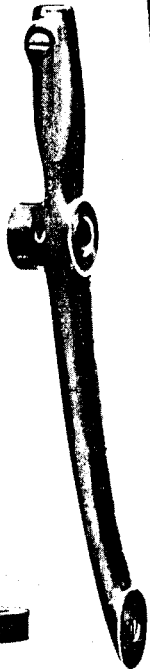
20284



16506



19371

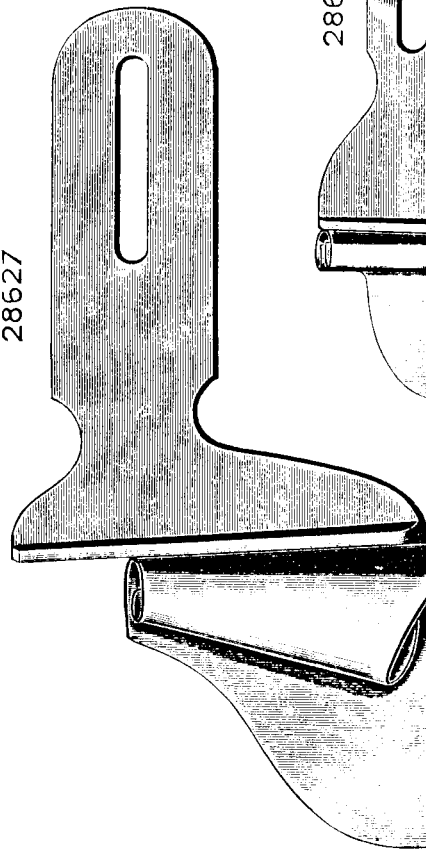


43976

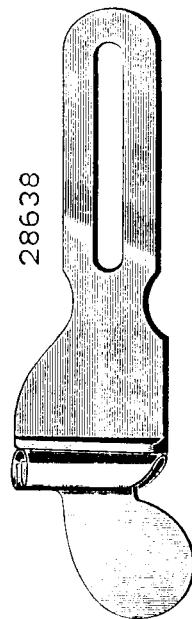


PLATE 2600—FULL SIZE

28627



28638



28628

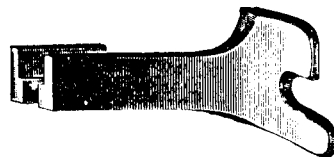
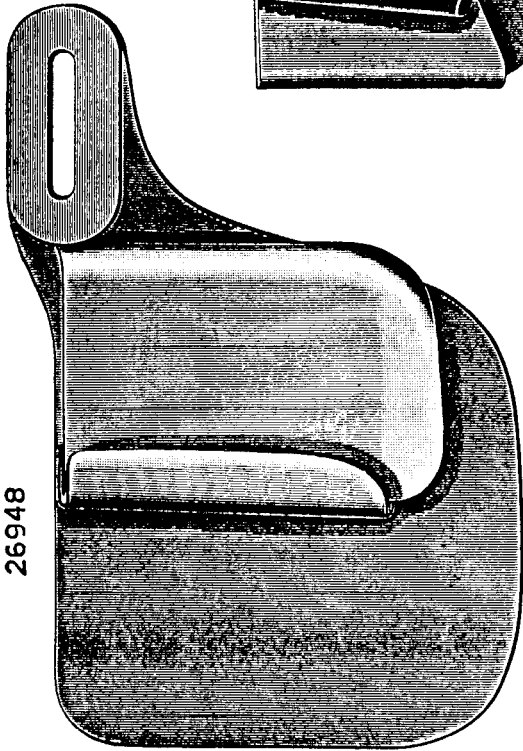


PLATE 2601—FULL SIZE

26948



28636

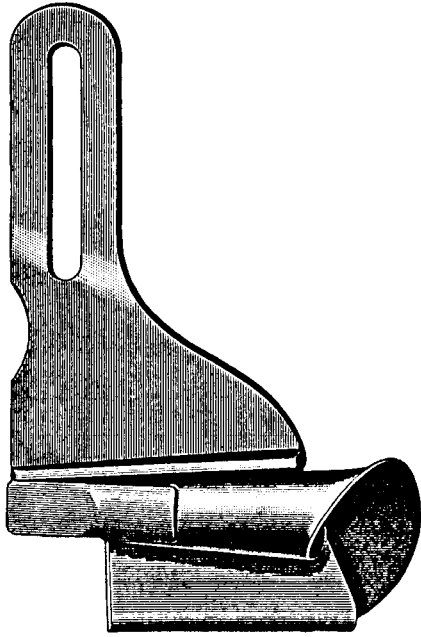
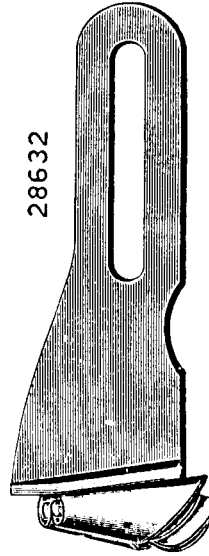


PLATE 2602—FULL SIZE

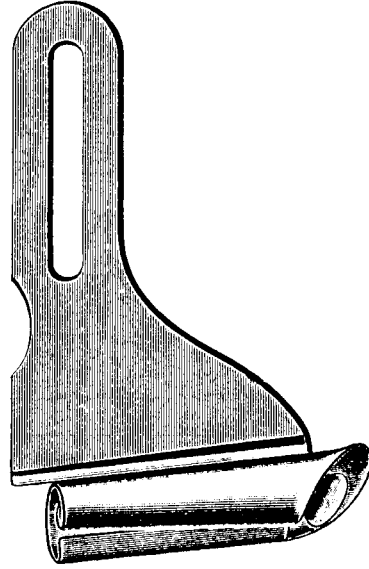
28624



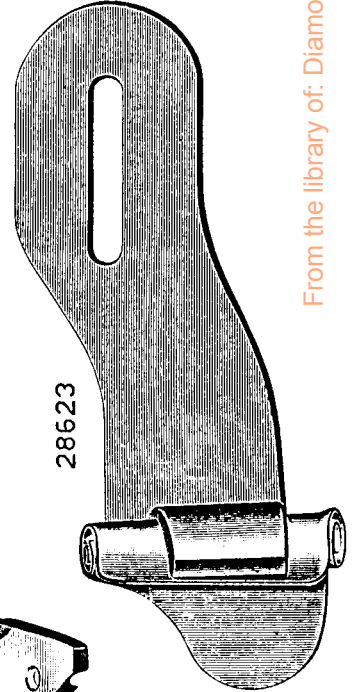
28632



28634



28623



28631

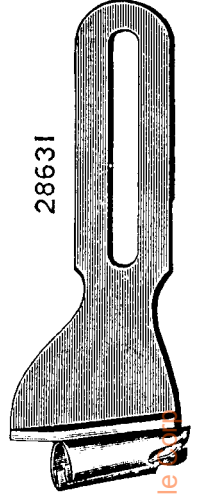


PLATE 2603—FULL SIZE

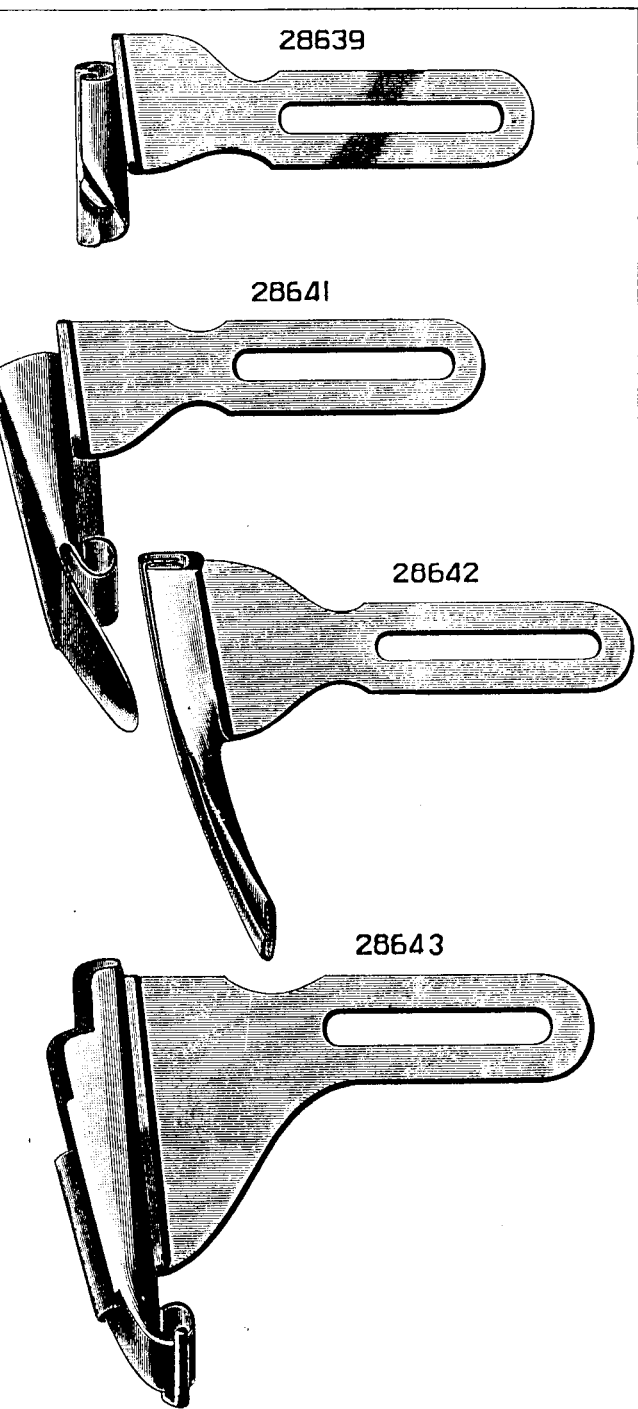


PLATE 2604—FULL SIZE

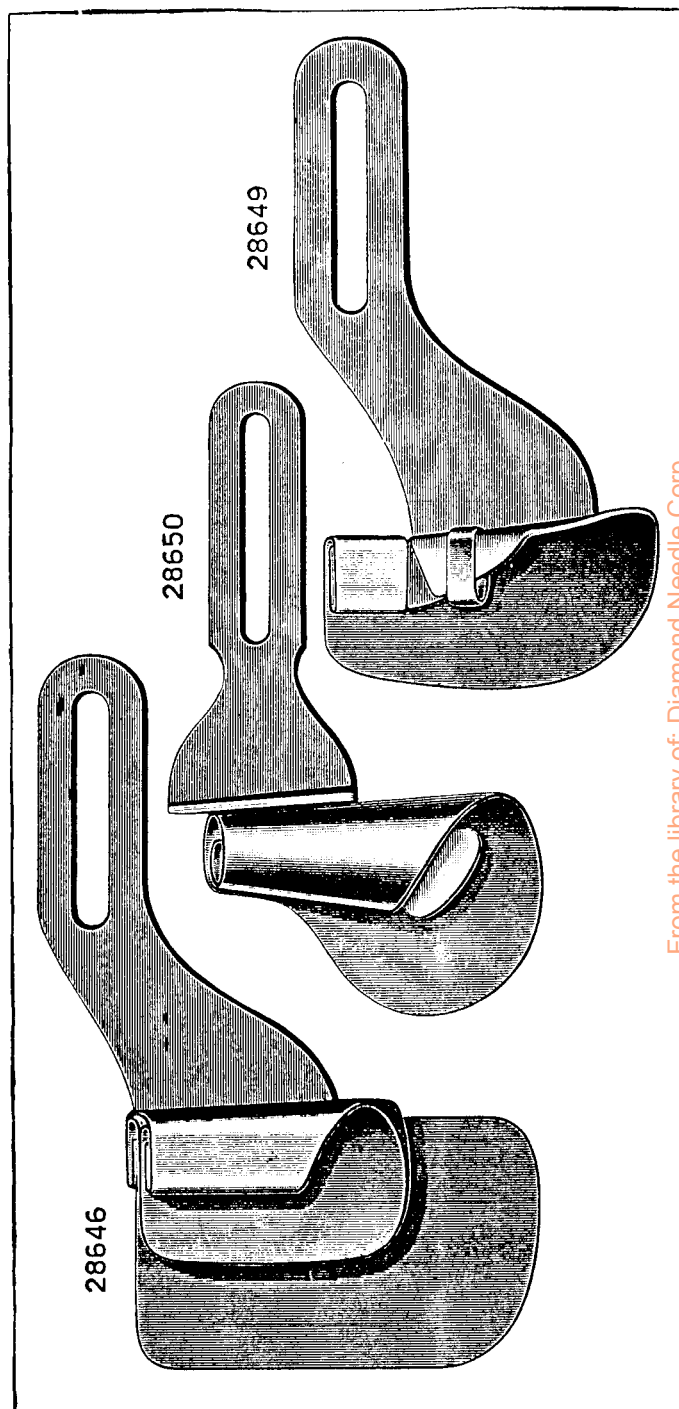


PLATE 2605—FULL SIZE

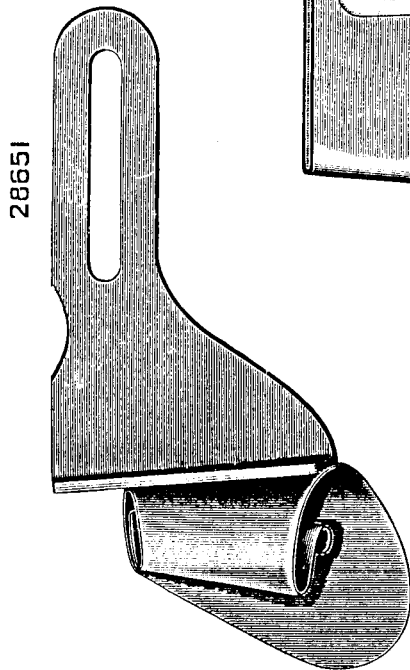
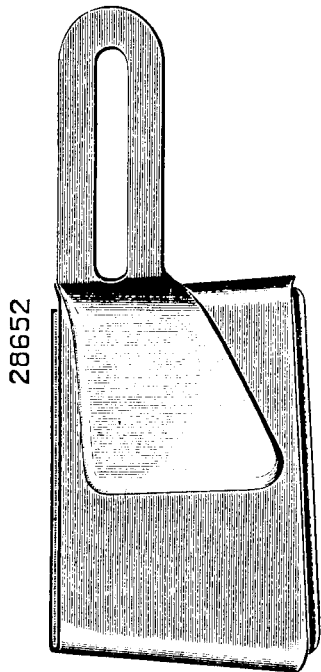
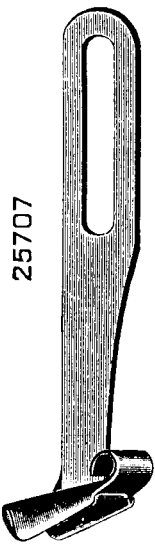
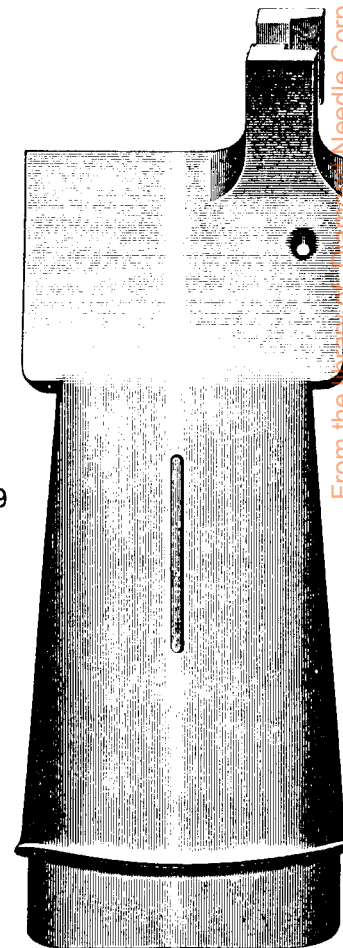
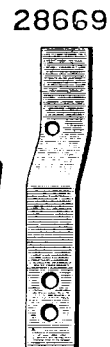
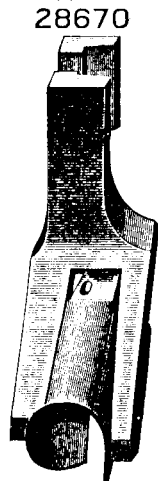
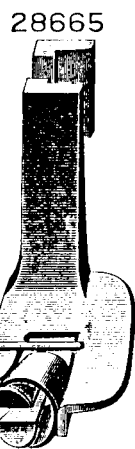
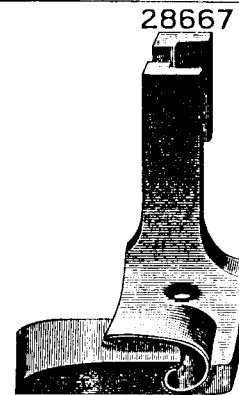
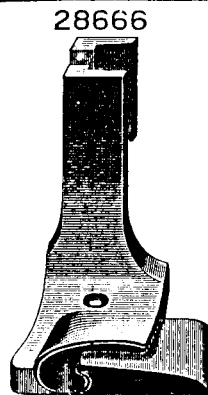


PLATE 2606—FULL SIZE



From the Library of the University of Illinois at Urbana-Champaign

PLATE 2607—FULL SIZE

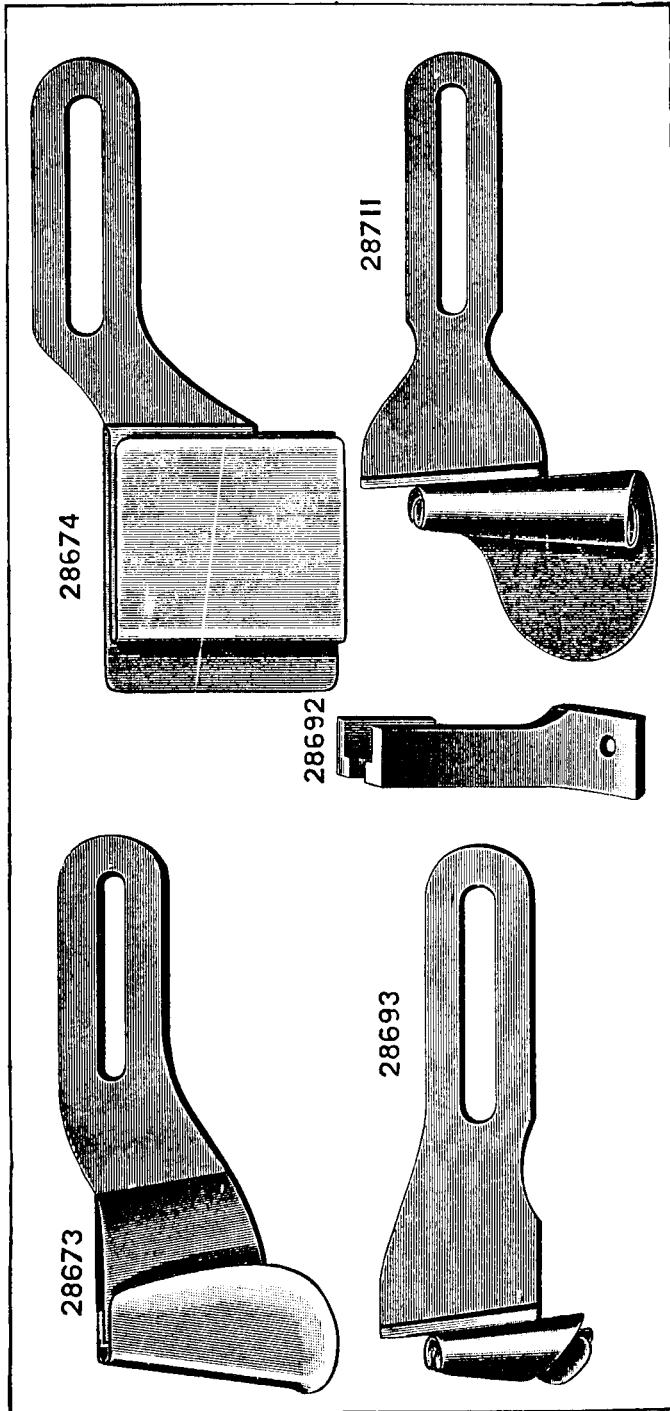
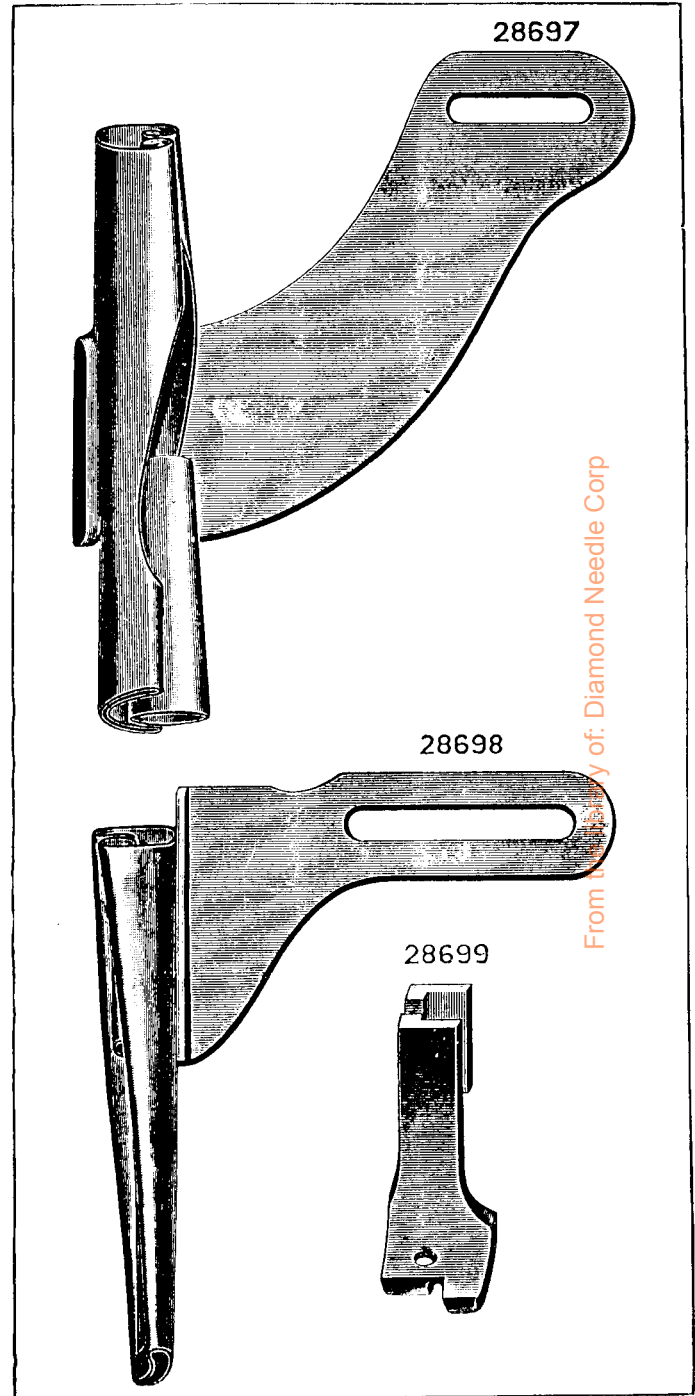
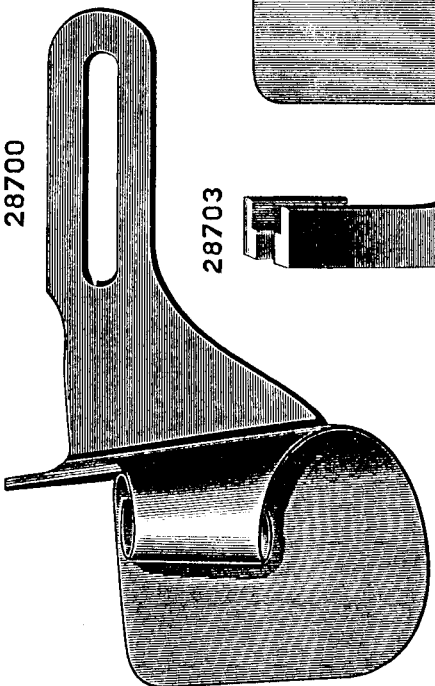


PLATE 2608—FULL SIZE

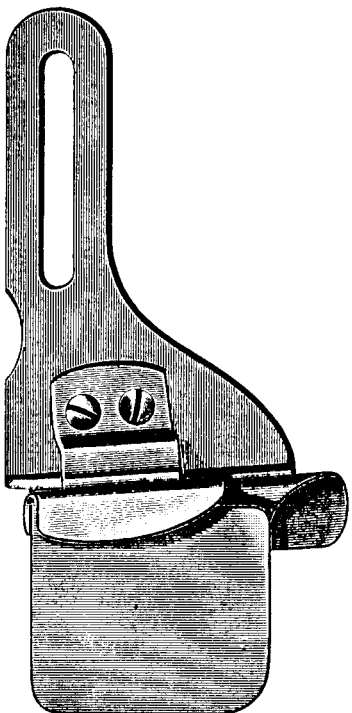


From the Library of: Diamond Needle Corp

PLATE 2609—FULL SIZE



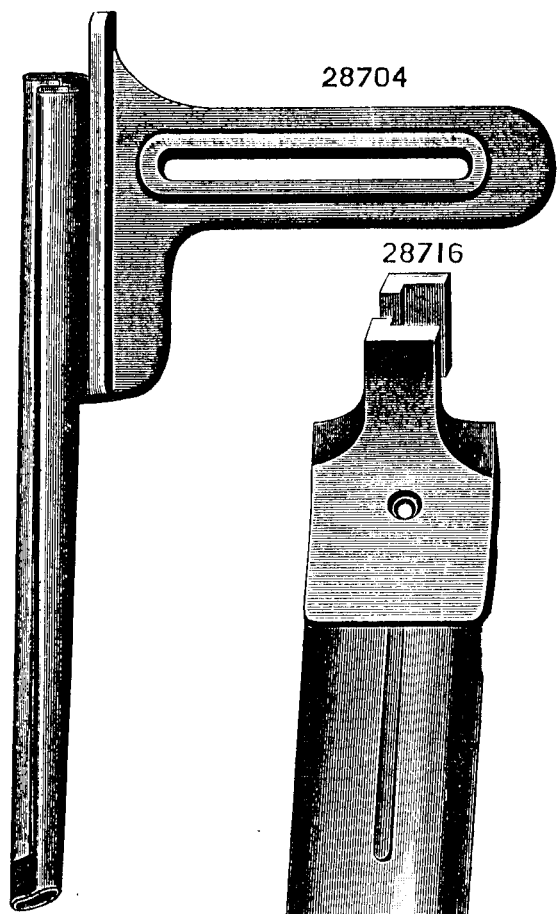
28702



28703



PLATE 2610—FULL SIZE



28704

28716

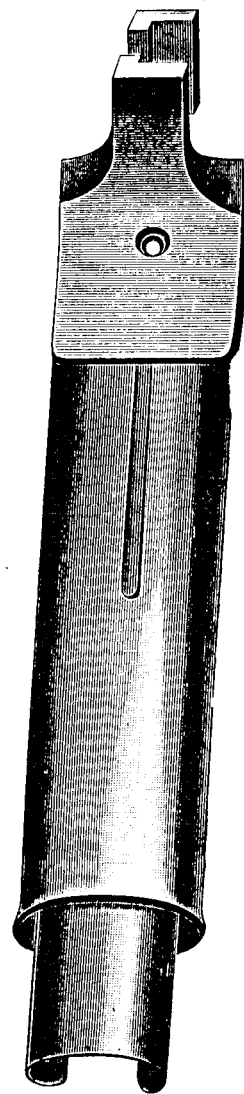
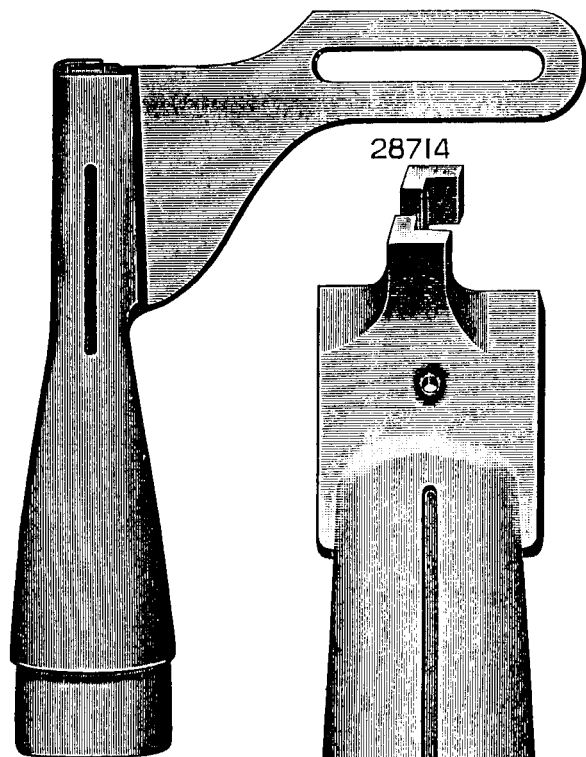


PLATE 2611—FULL SIZE

28708



28714

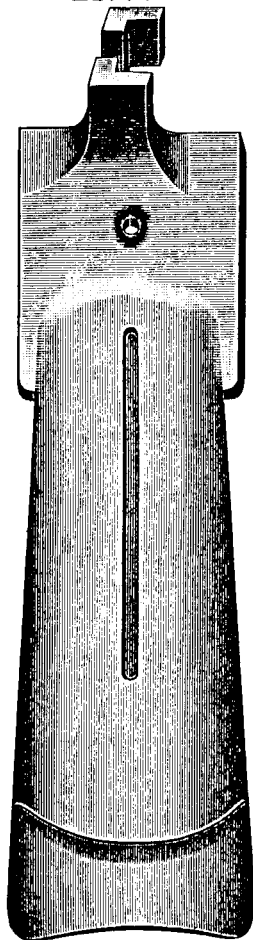
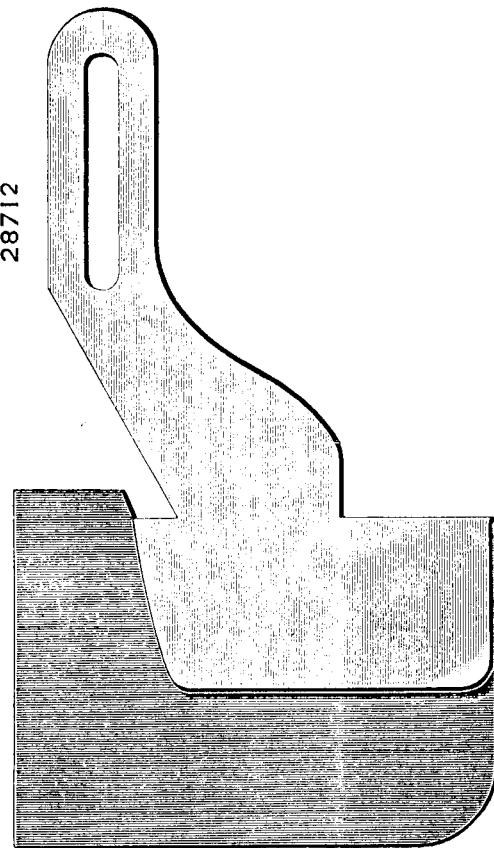


PLATE 2612—FULL SIZE

28712



28710

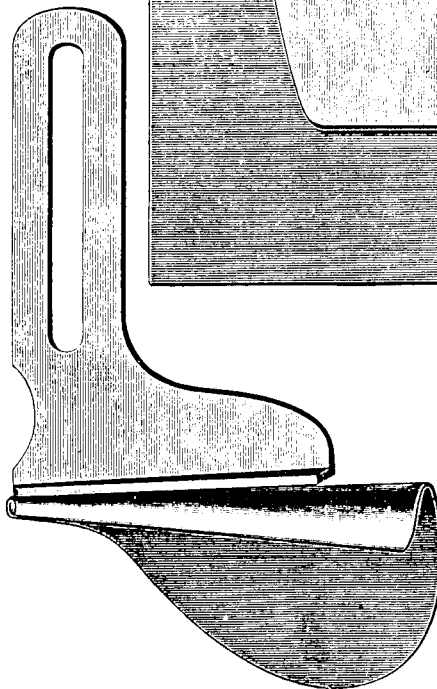


PLATE 2613—FULL SIZE

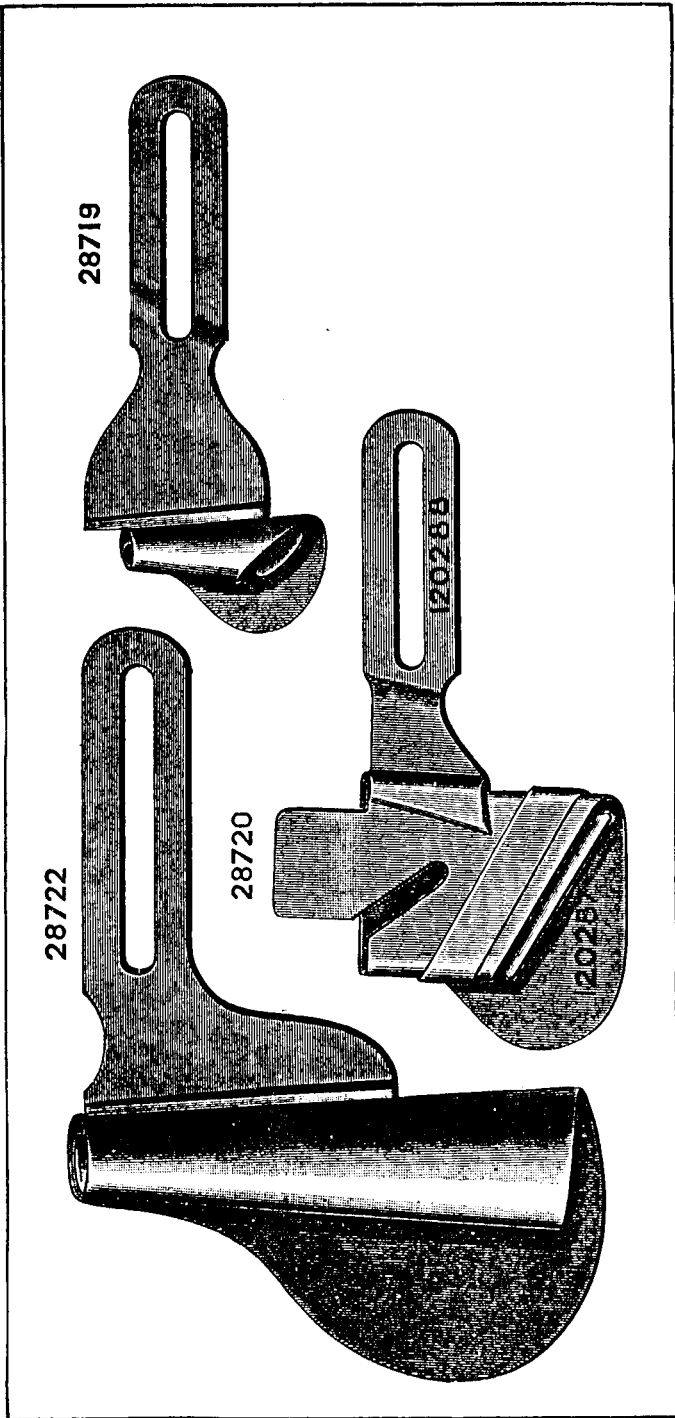
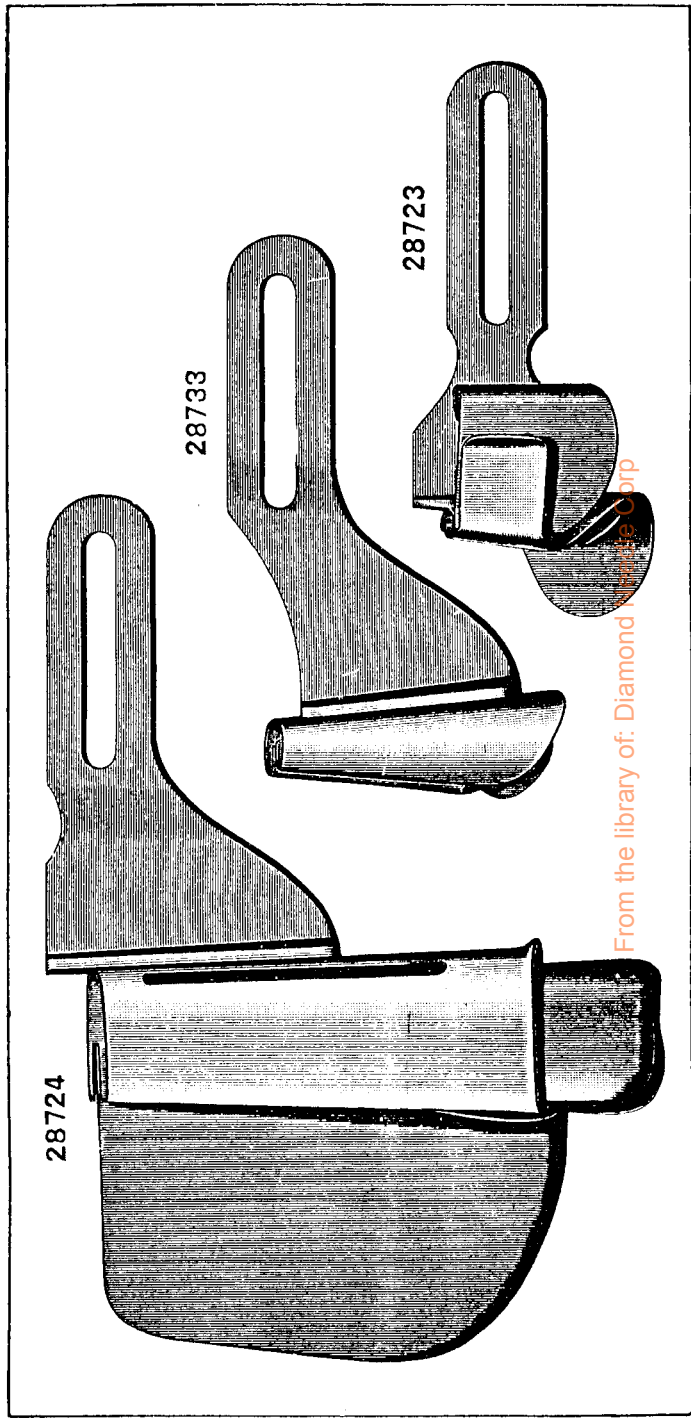
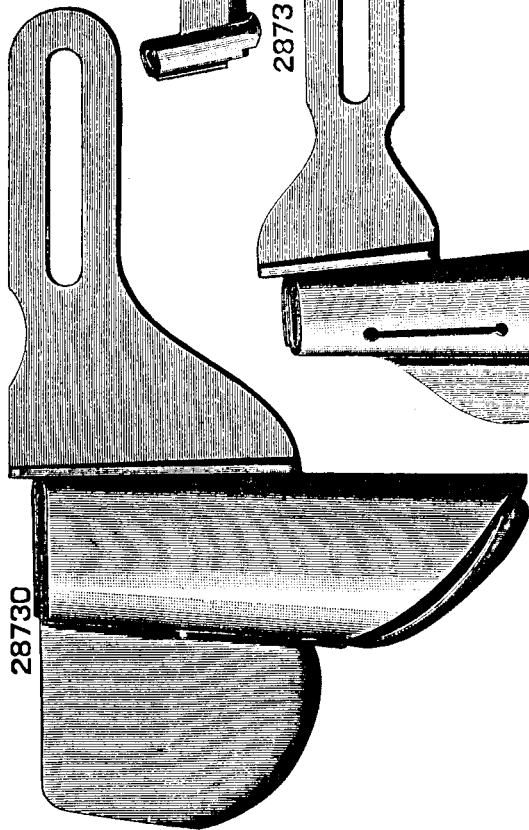


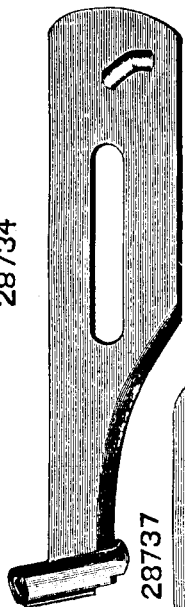
PLATE 2614—FULL SIZE



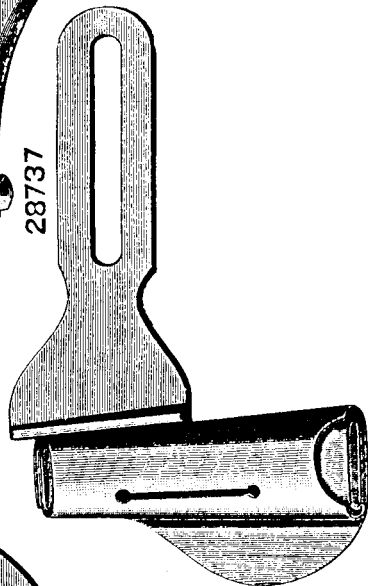
28730



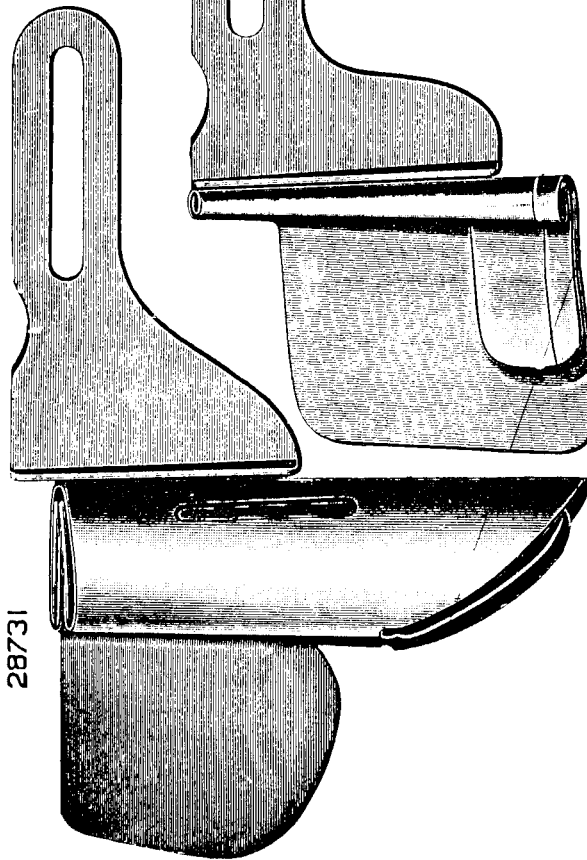
28734



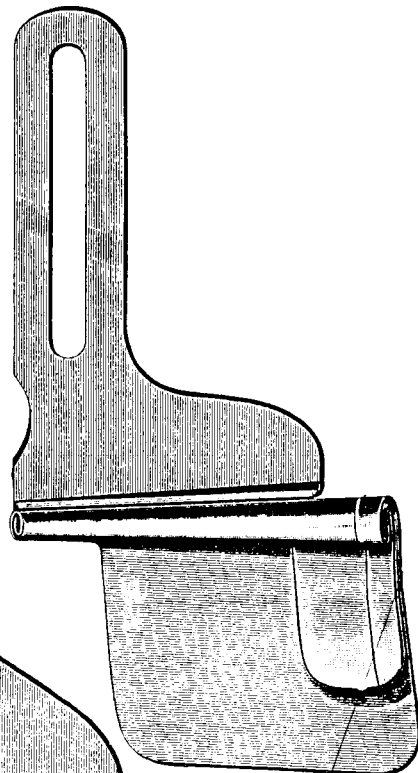
28737



28731



28735



35454

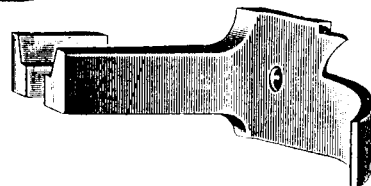


PLATE 2617—FULL SIZE

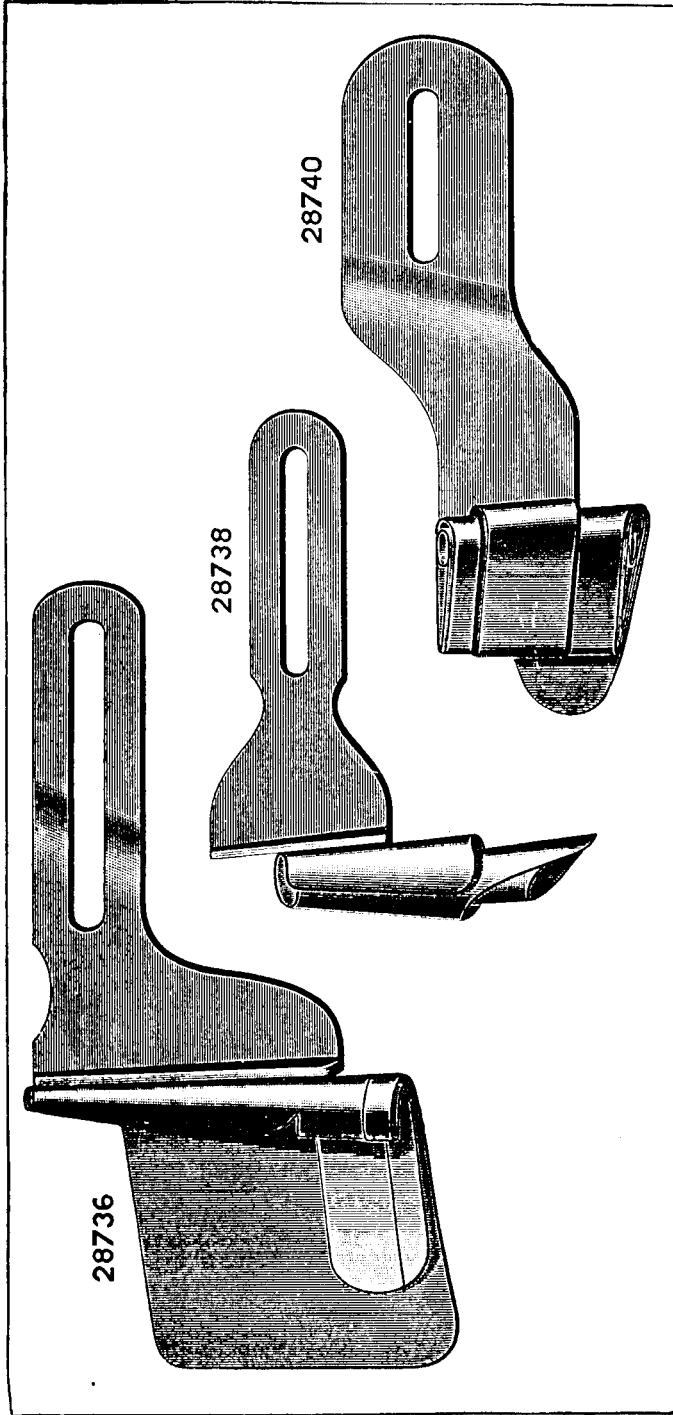


PLATE 2618—FULL SIZE

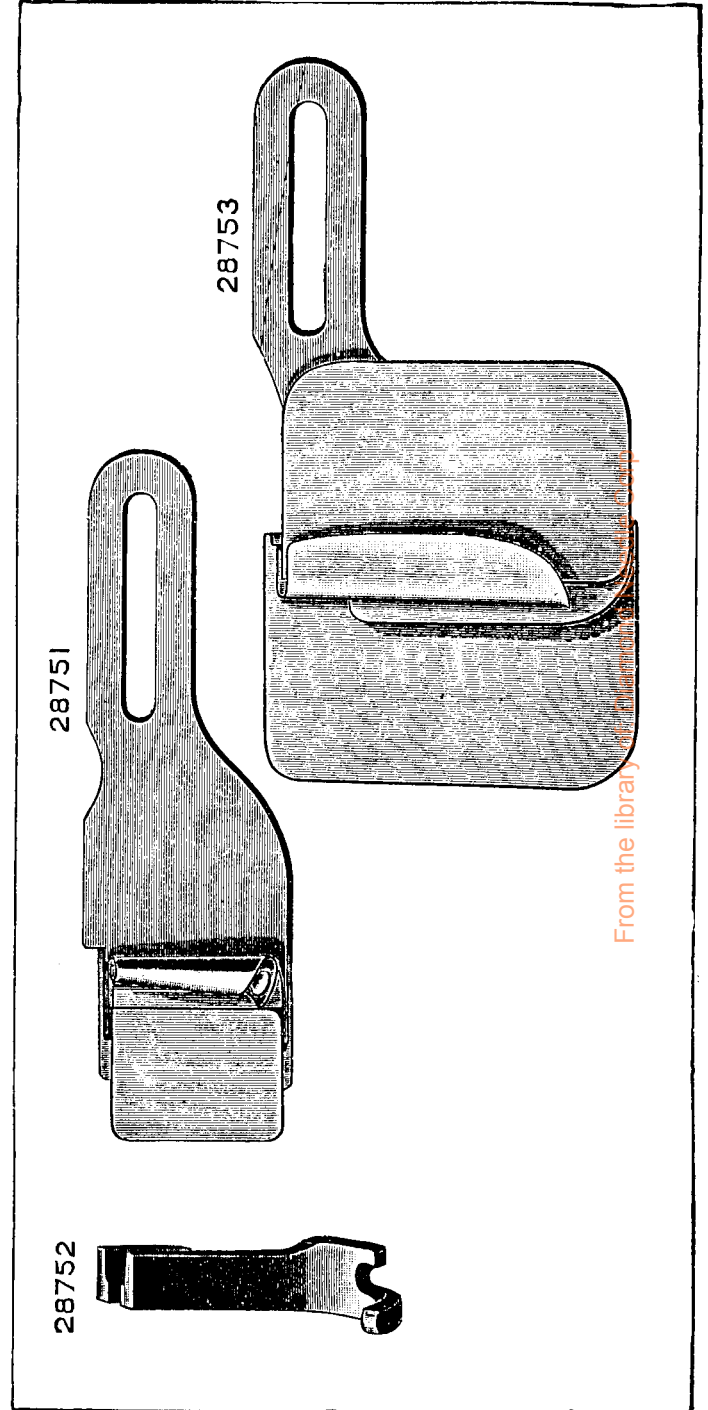


PLATE 2619—FULL SIZE

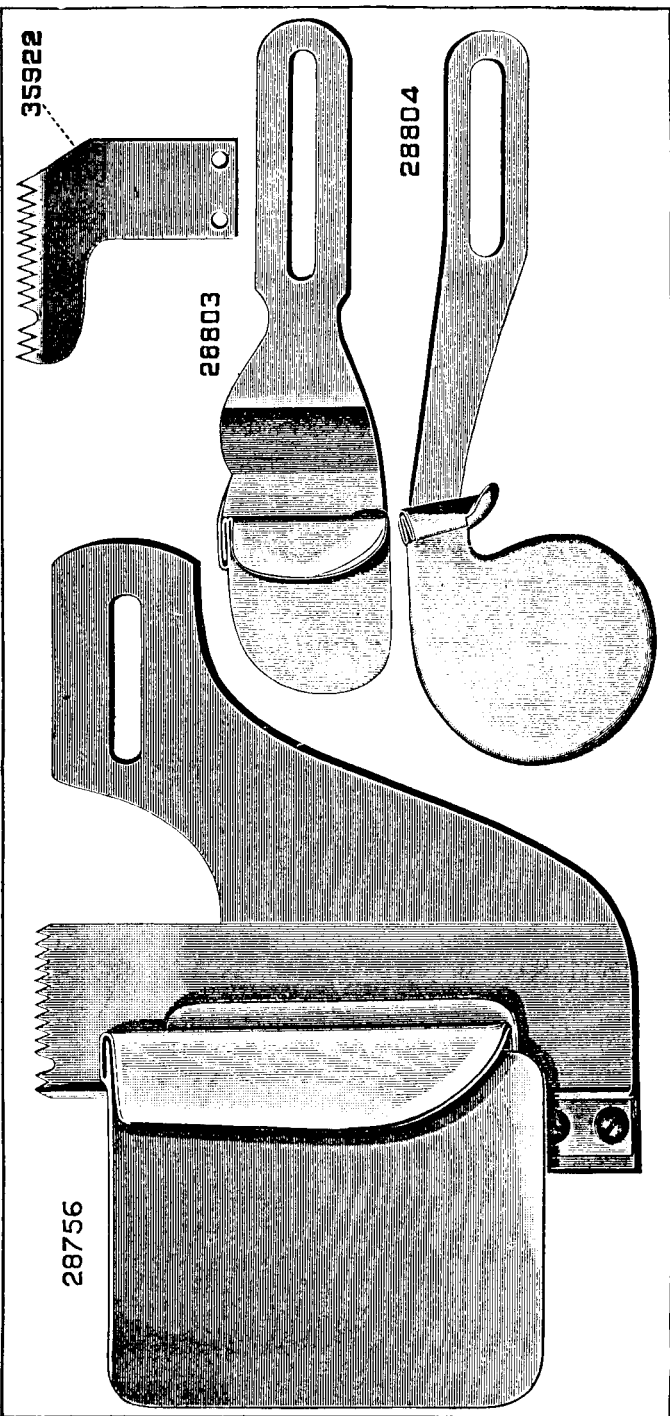


PLATE 2620—FULL SIZE

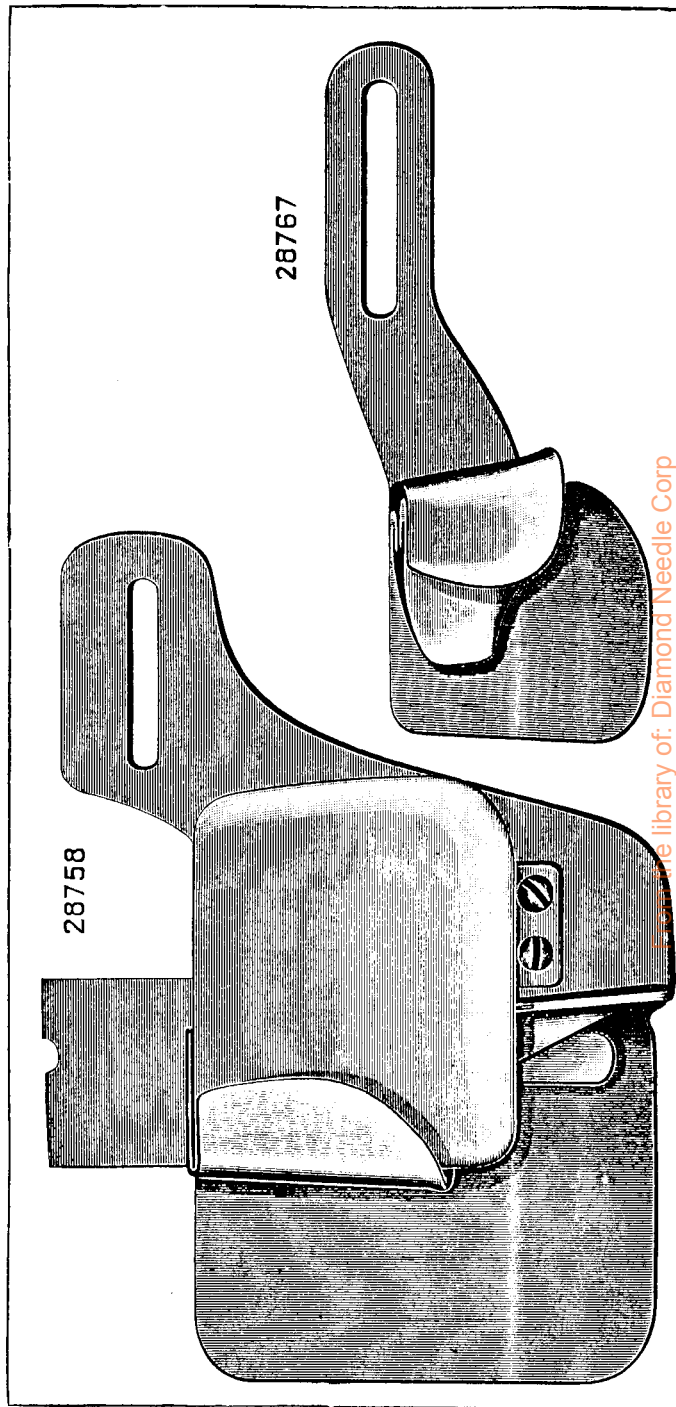
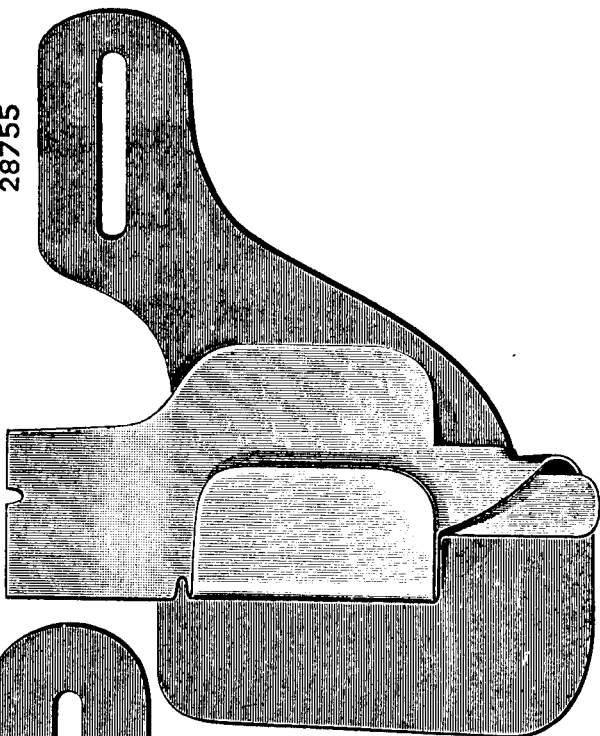


PLATE 2621—FULL SIZE

28755



28763

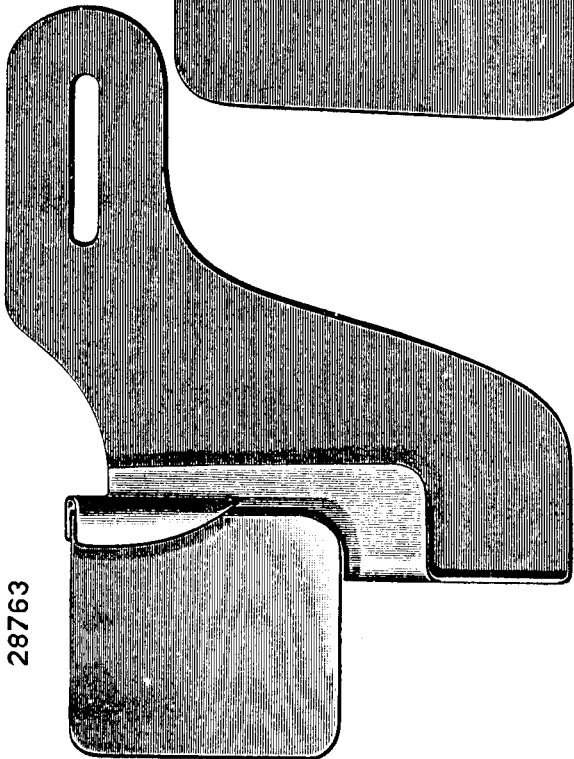
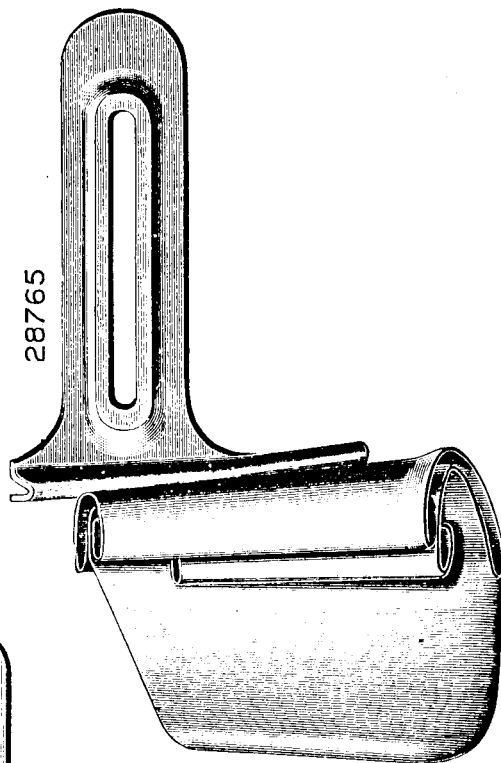
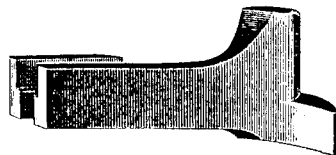


PLATE 2622—FULL SIZE

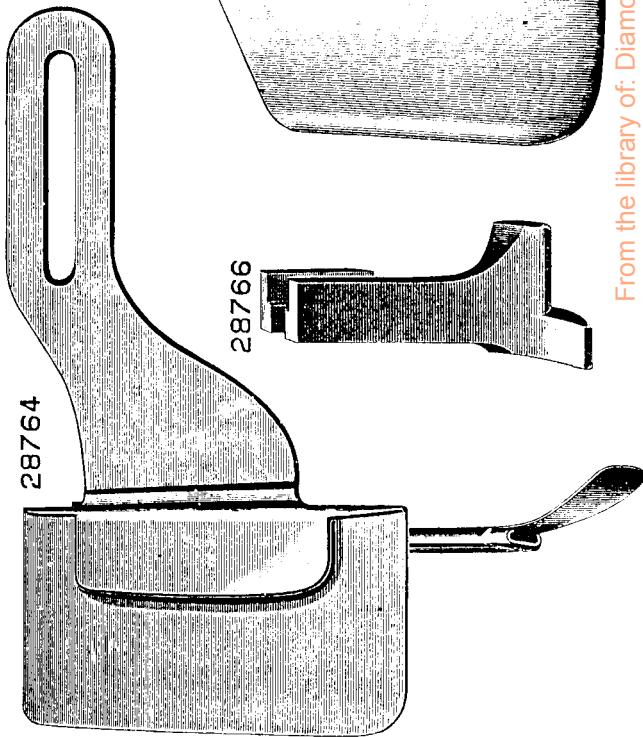
28765



28766



28764



From the library of: Diamond Needle Corp

PLATE 2623—FULL SIZE

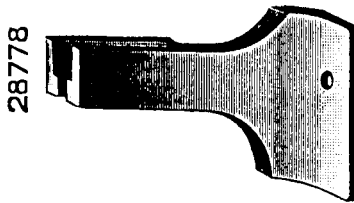
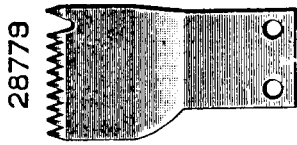
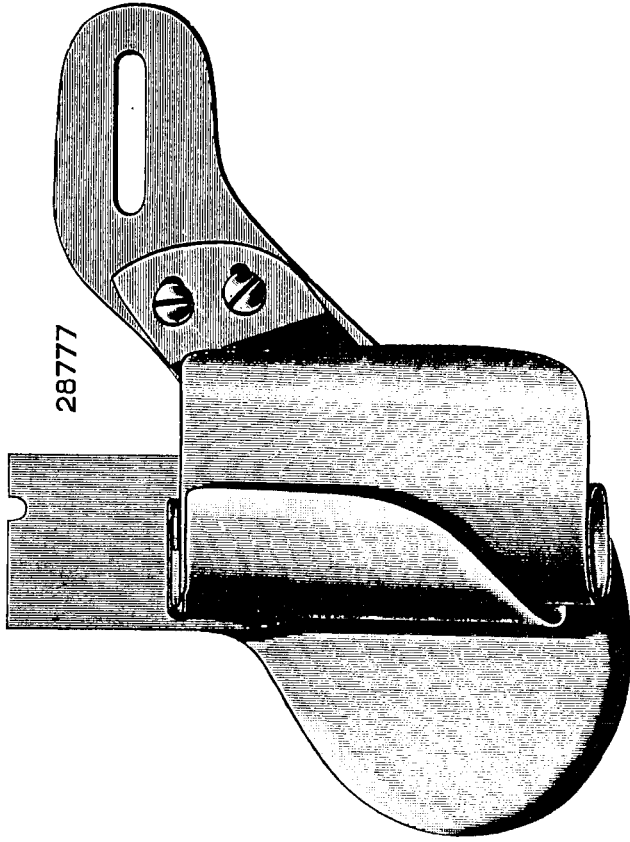
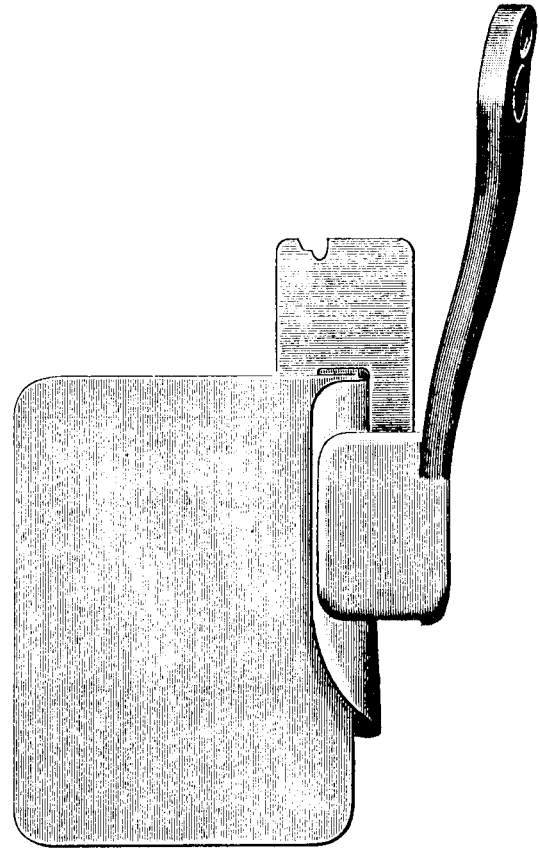


PLATE 2624—FULL SIZE

28358



From the library of: Diamond Needle Corp

PLATE 2625—FULL SIZE

288!!

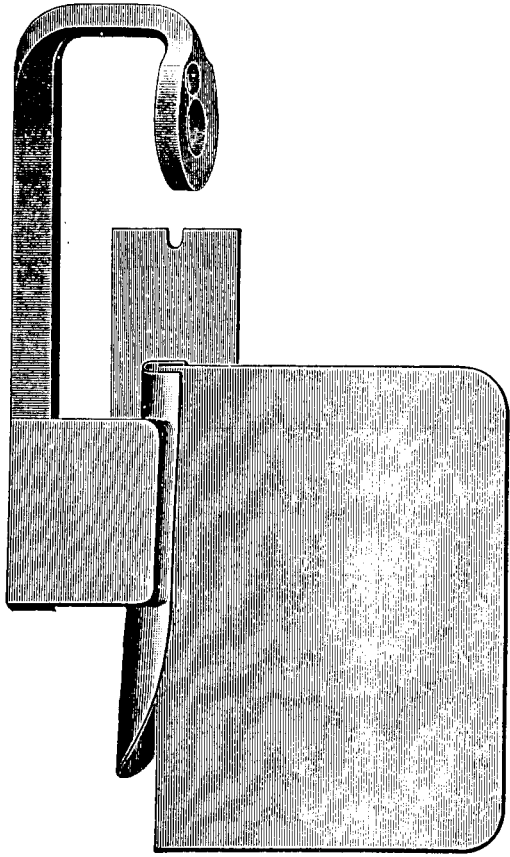
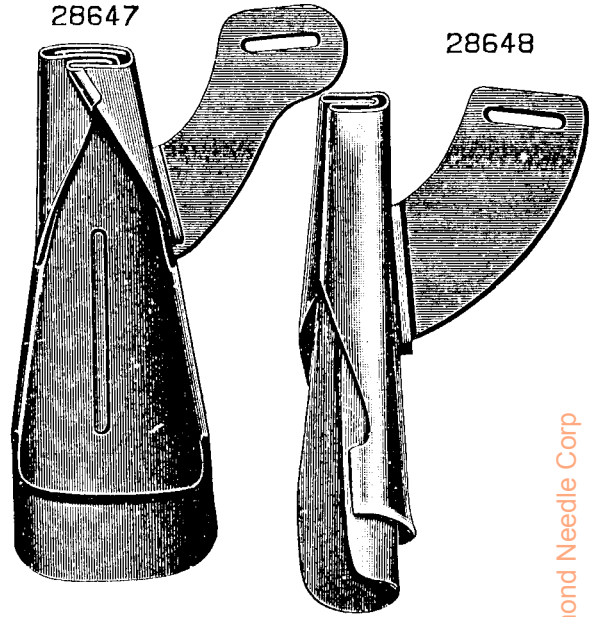


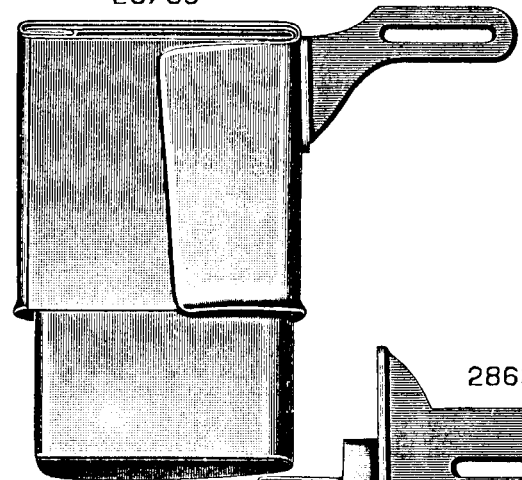
PLATE 2626—ONE-HALF SIZE

28647

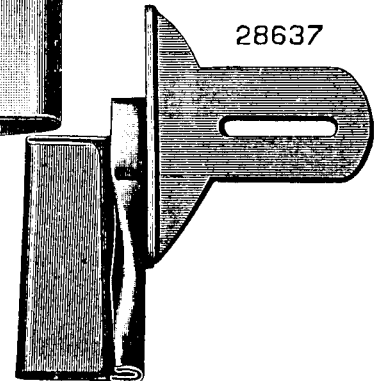
28648



28739



28637



From the library of: Diamond Needle Corp

PLATE 2627—ONE-HALF SIZE

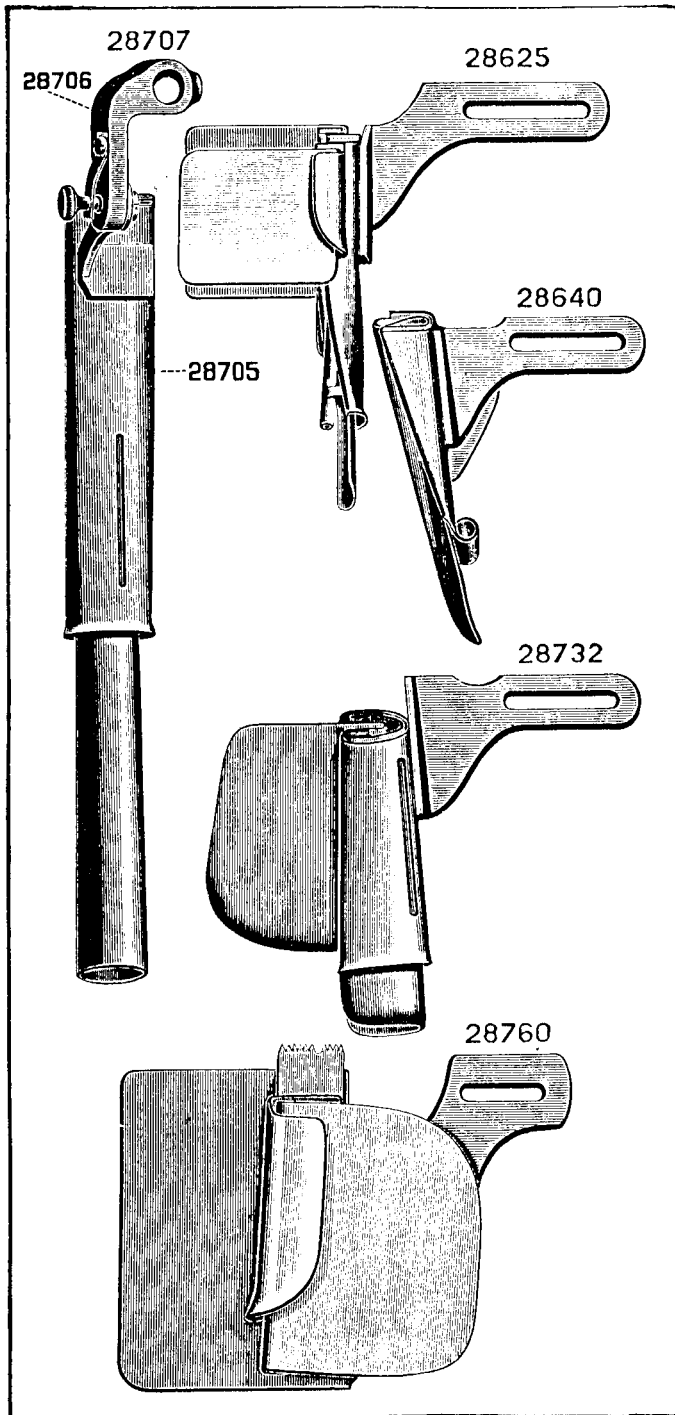


PLATE 2628—ONE-HALF SIZE

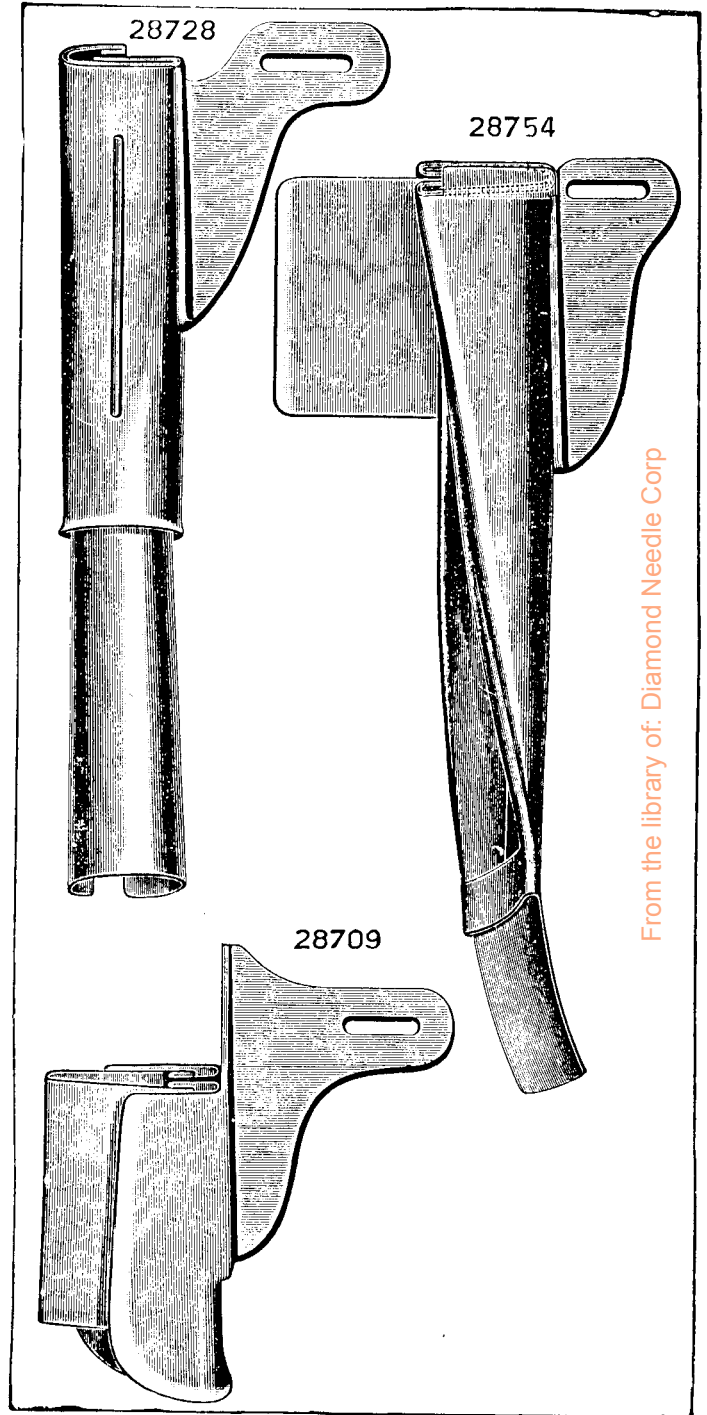


PLATE 2629—ONE-HALF SIZE

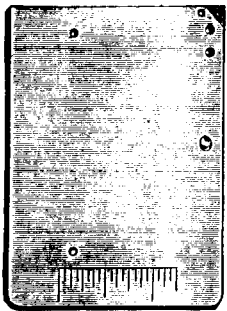
26893



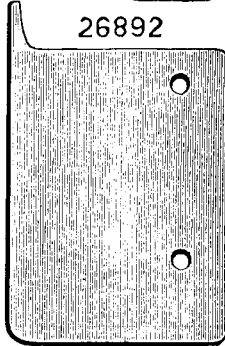
26438



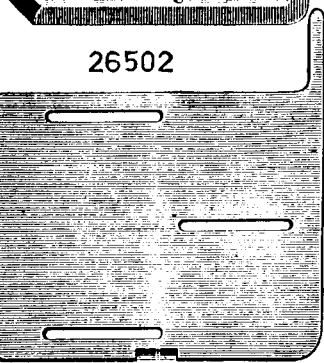
26894



26892



26437



26502

26592

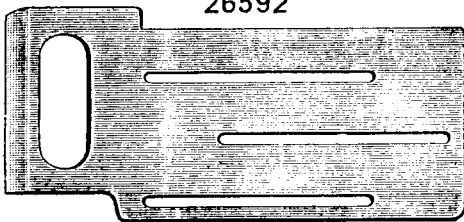
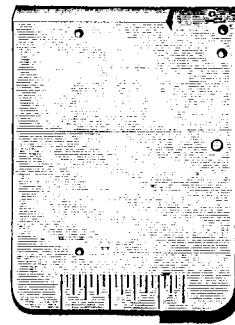


PLATE 2630—ONE-HALF SIZE

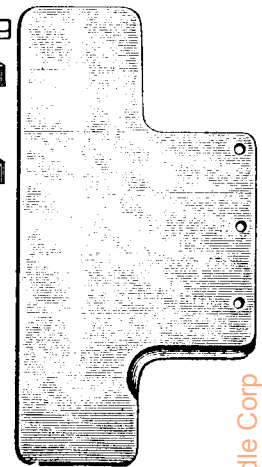
26898



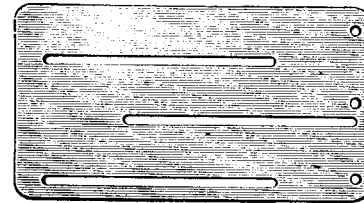
26449



26450



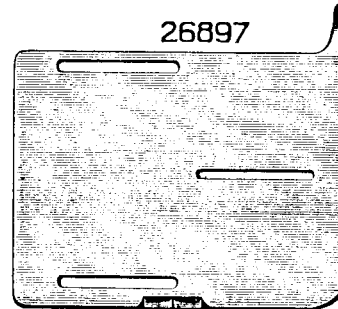
26451



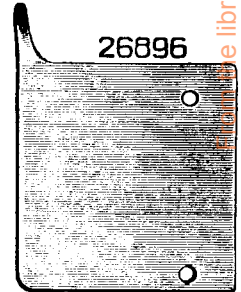
26636



26897



26896



Library of: Diamond Needle Corp

PLATE 2631—FULL SIZE

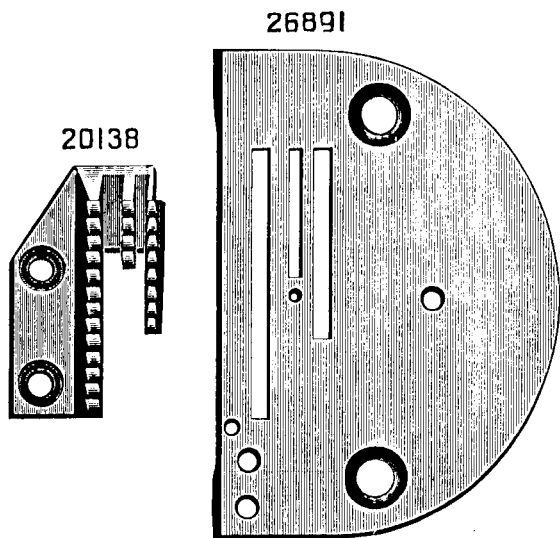


PLATE 2632—ONE-HALF SIZE

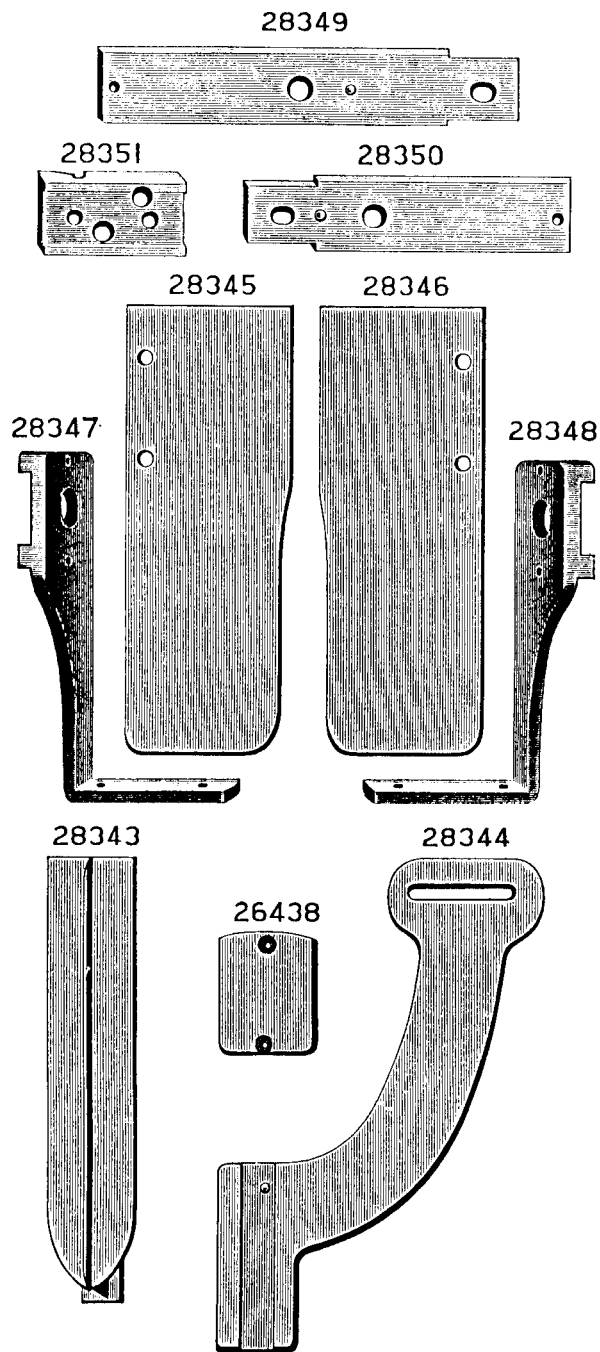


PLATE 2633—FULL SIZE

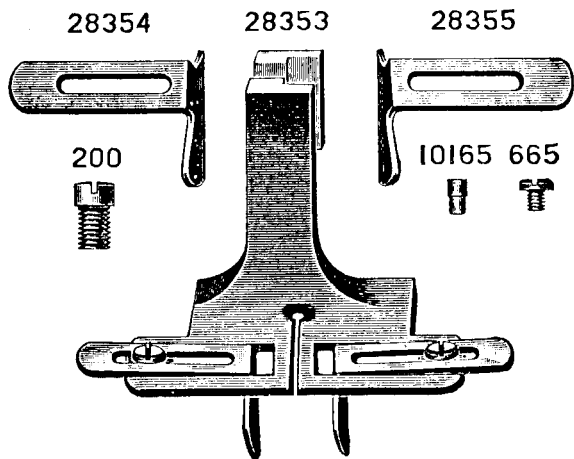


PLATE 2634—ONE-FOURTH SIZE

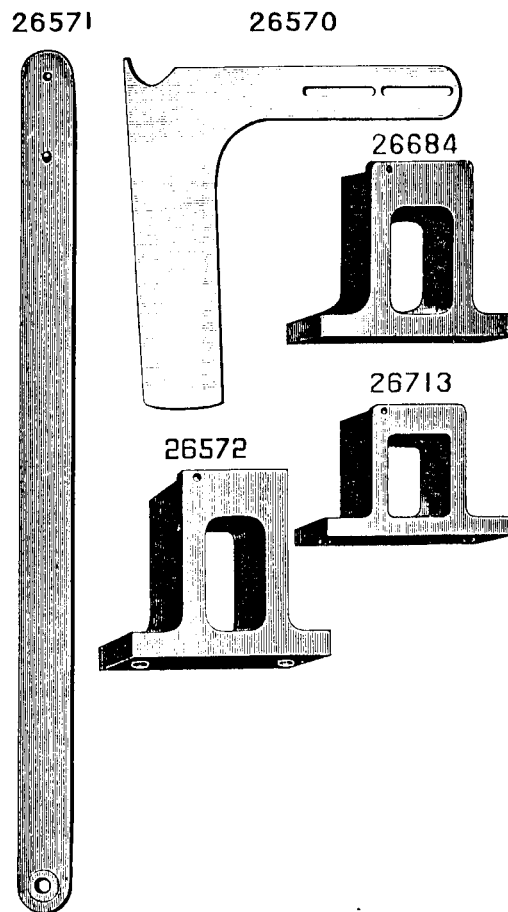
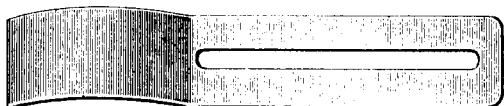
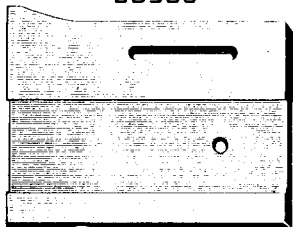


PLATE 2635—ONE-HALF SIZE

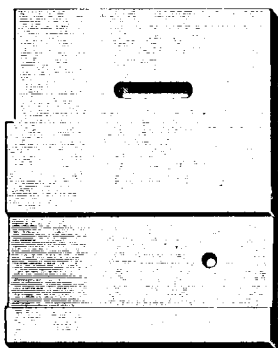
26569



26568



26710



35159

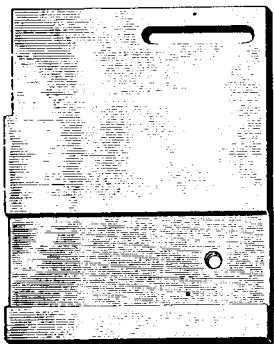


PLATE 2636—FULL SIZE

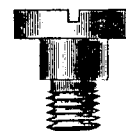
939



732



58



287



26686



7071



5944



From the library of: Diamond Needle Corp

PLATE 2637—ONE-FOURTH SIZE

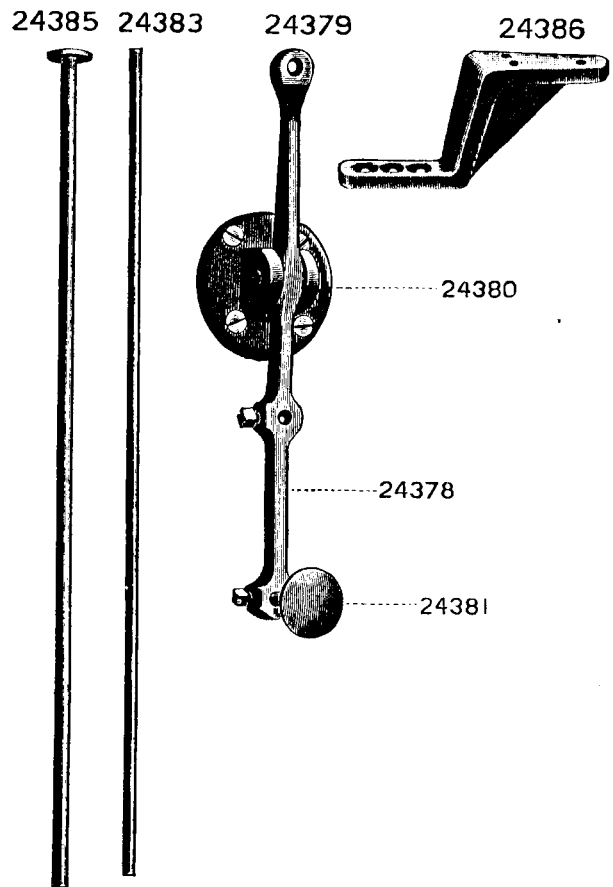
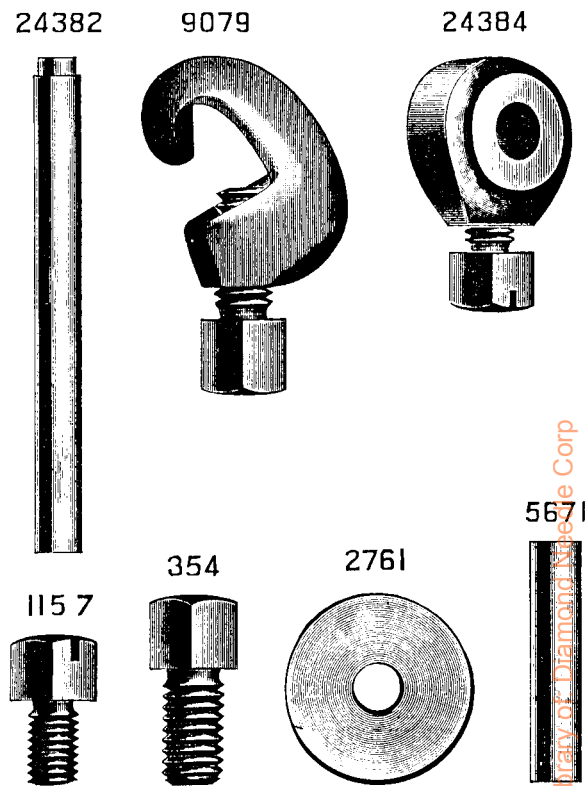


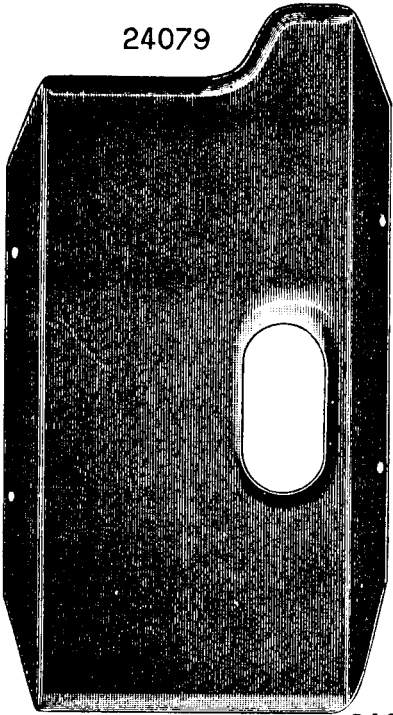
PLATE 2638—FULL SIZE



From the library of Diamond Machine Corp

PLATE 2644—ONE-FOURTH SIZE

24079



24080

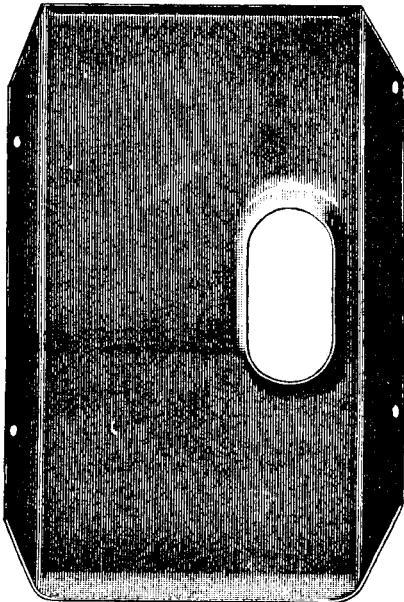
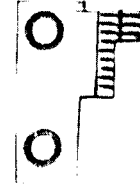
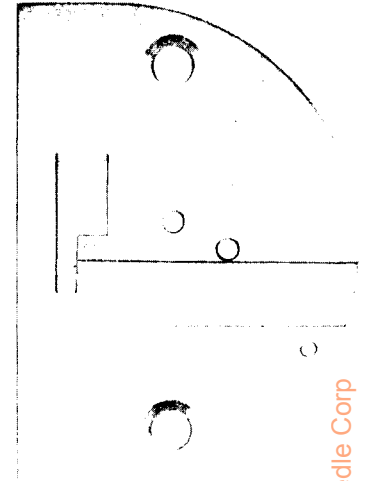


PLATE 2645—FULL SIZE

28790



28792



28793



28791



28366



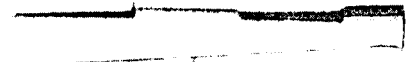
2011



2010



28350



28853



28859



36620



337



23219 242



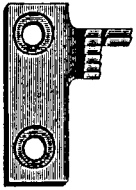
2885



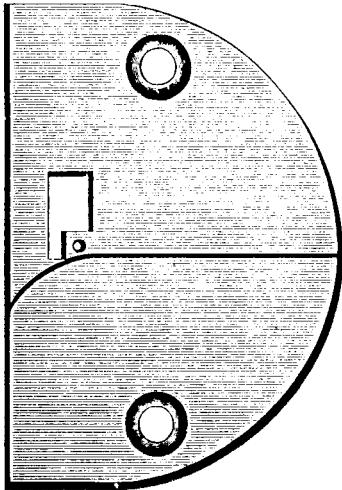
From the Library of: Diamond Needle Corp

PLATE 2646—FULL SIZE

28824



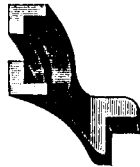
28826



28825



28827



28823

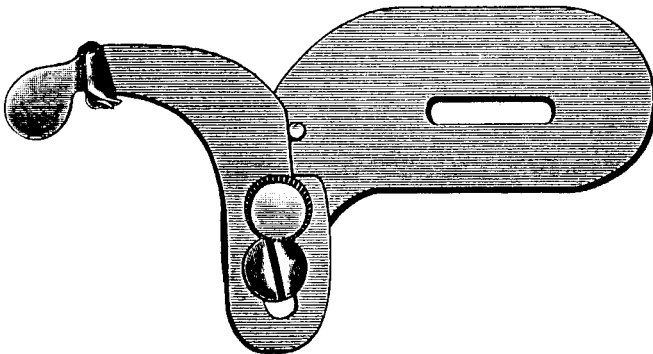


PLATE 2647—FULL SIZE

24441



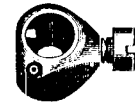
24442



24451



24453



24452



24457

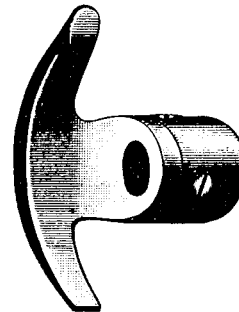
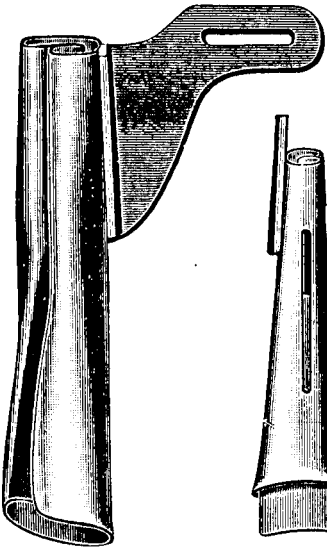
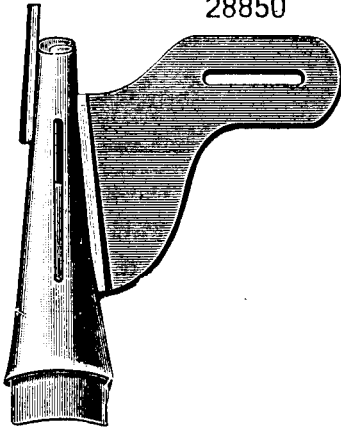


PLATE 2648—ONE-HALF SIZE

28848



28850



28851

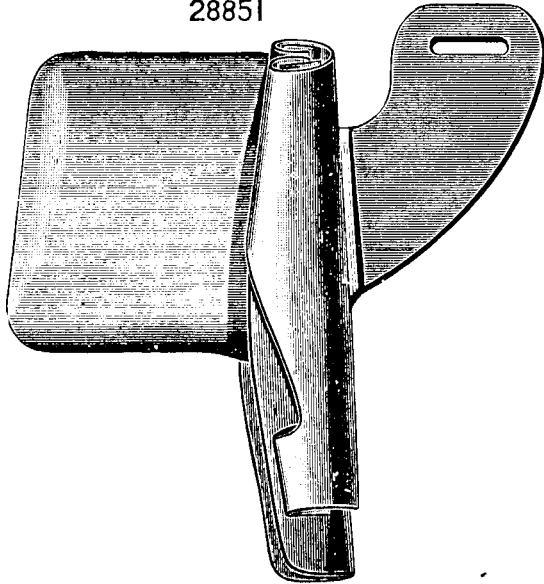
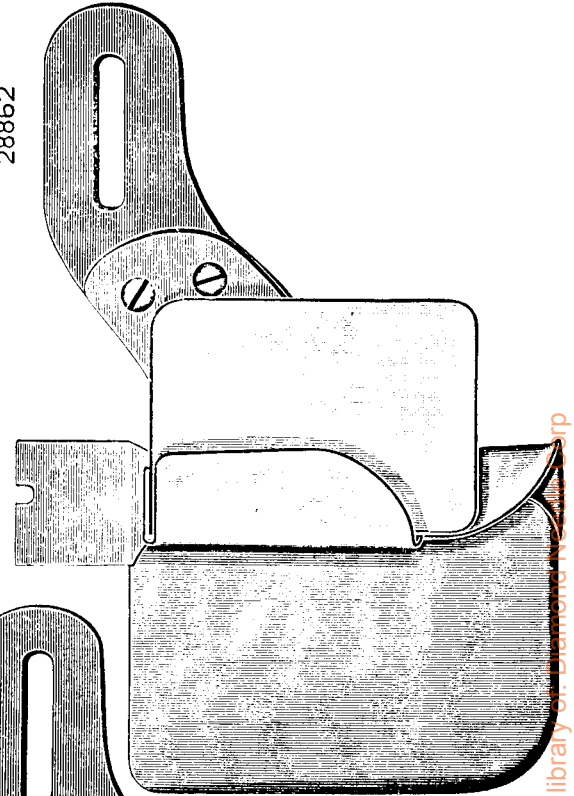


PLATE 2649—FULL SIZE

28862



28833

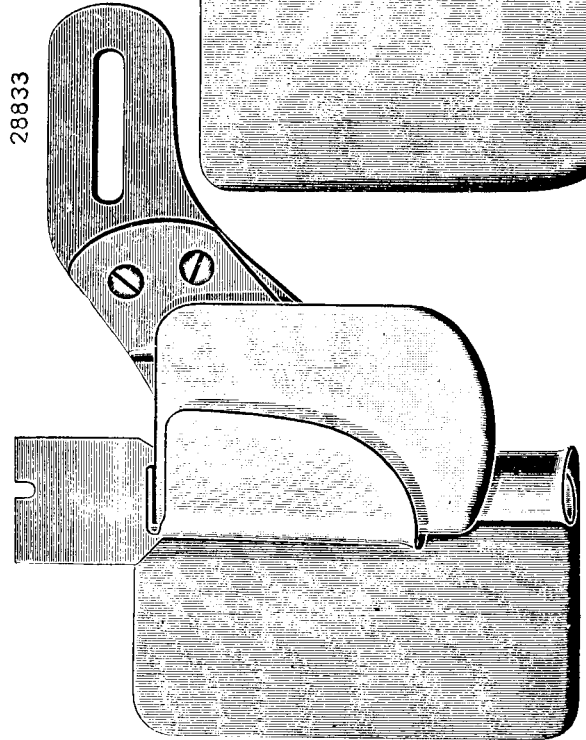


PLATE 2650—FULL SIZE

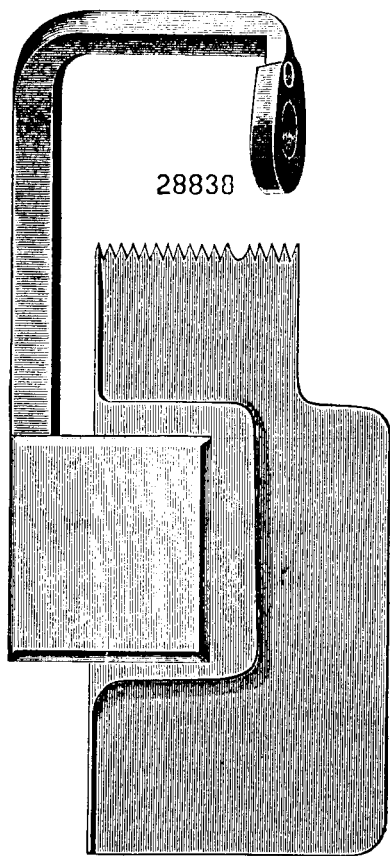
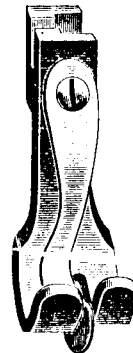


PLATE 2658—FULL SIZE

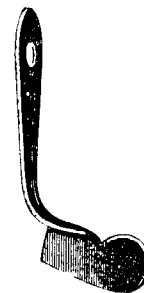
28900



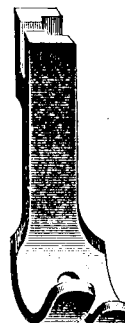
28909



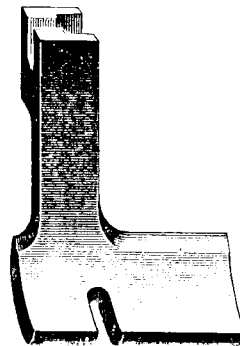
28908



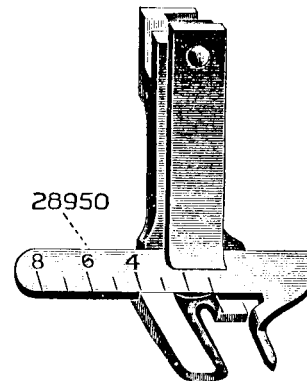
28975



28938



28953



28950

28967



198



28965



35040



28966



15072



From the library of: Diamond Needle Corp

PLATE 2659—FULL SIZE

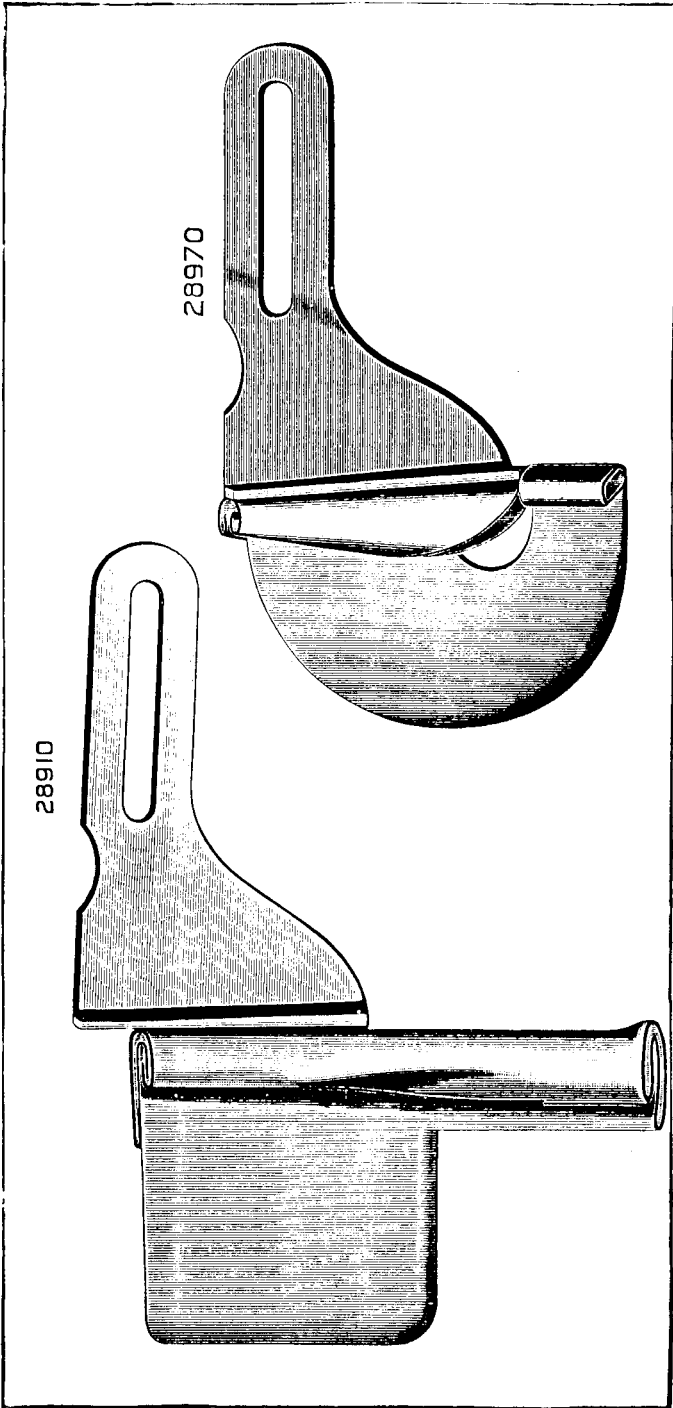


PLATE 2661—ONE-HALF SIZE

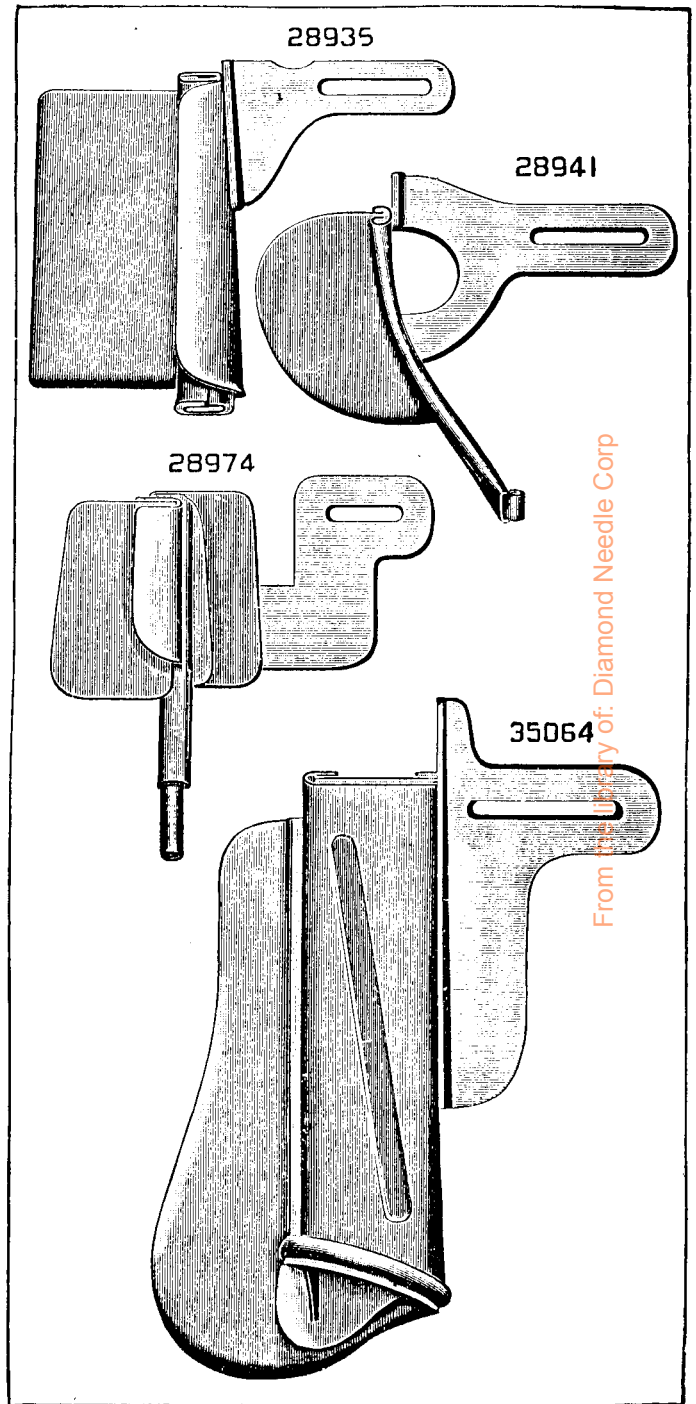
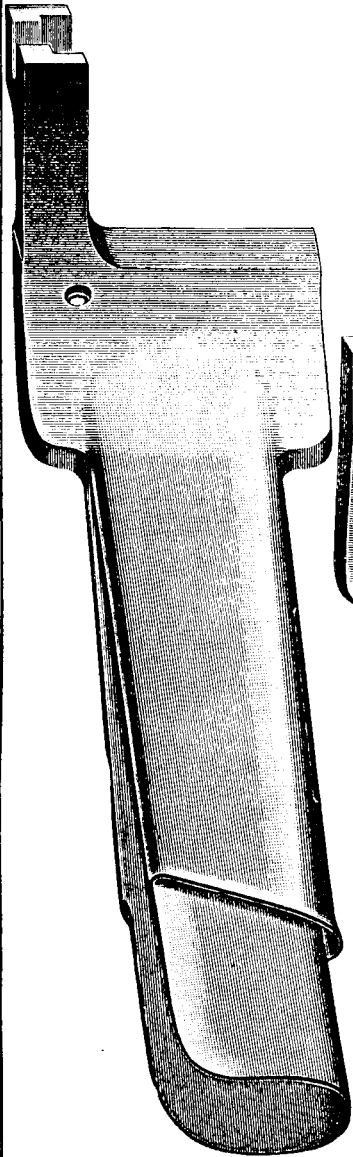


PLATE 2665—FULL SIZE

28944



28944

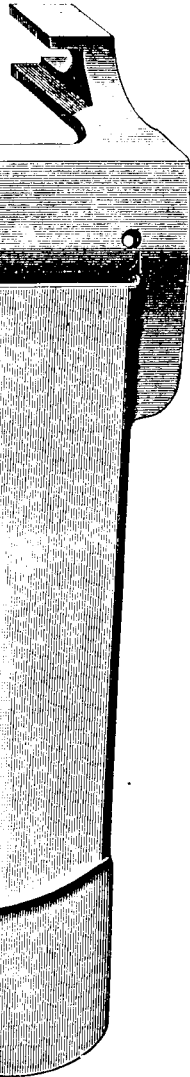
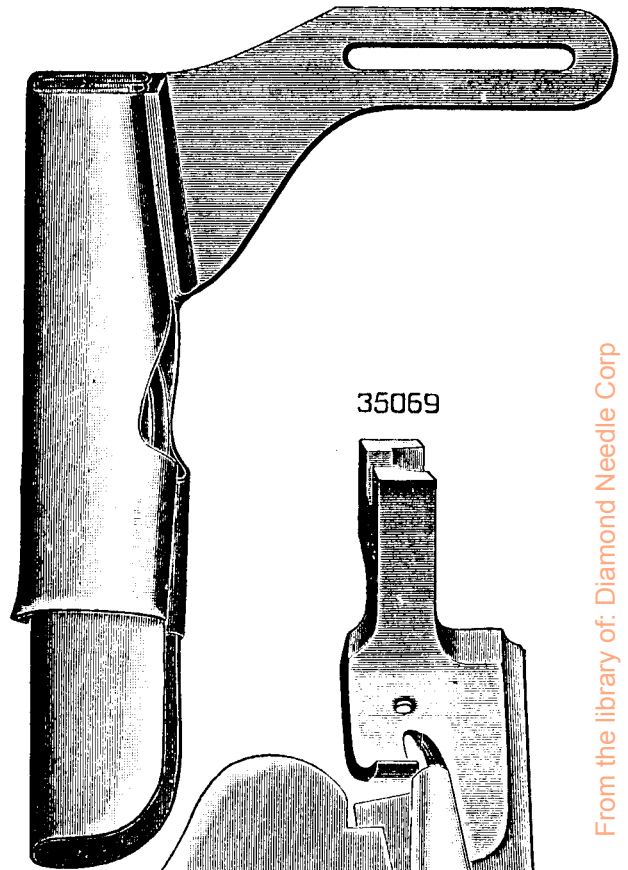
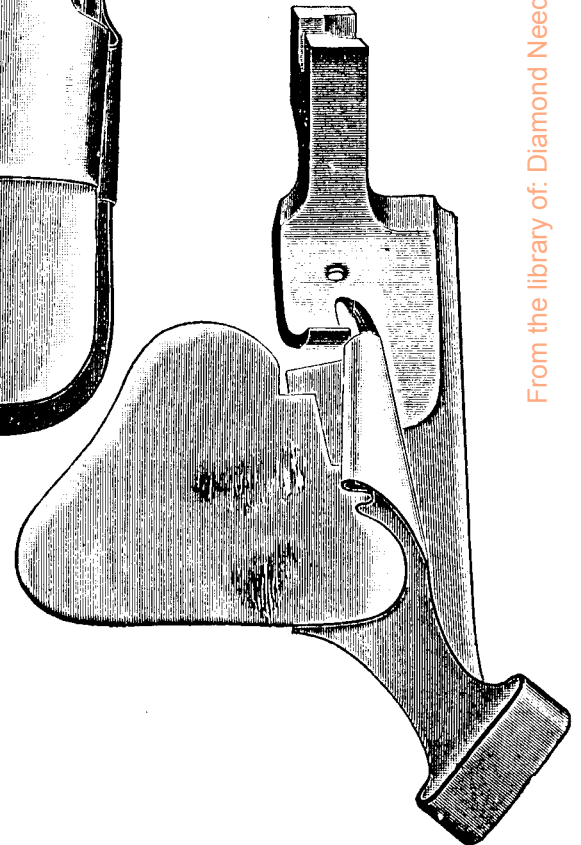


PLATE 2666—FULL SIZE

28945



35069



From the library of: Diamond Needle Corp

PLATE 2668—FULL SIZE

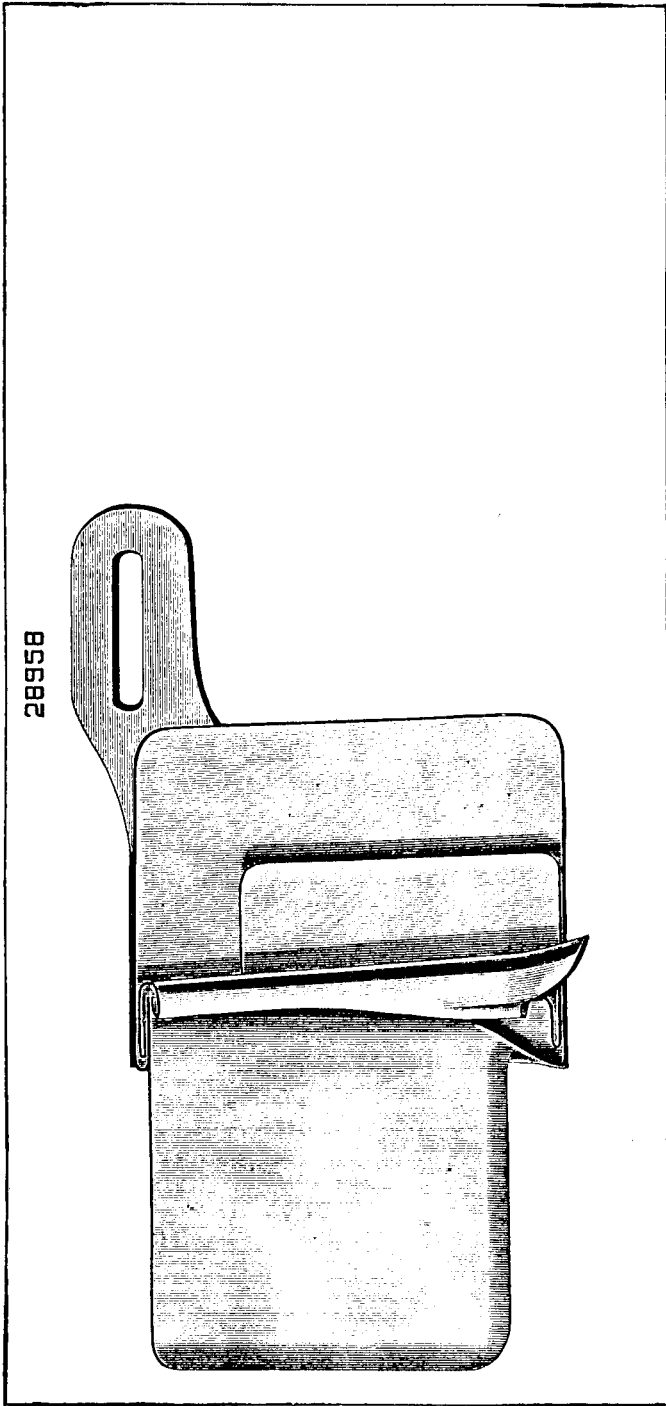


PLATE 2669—FULL SIZE

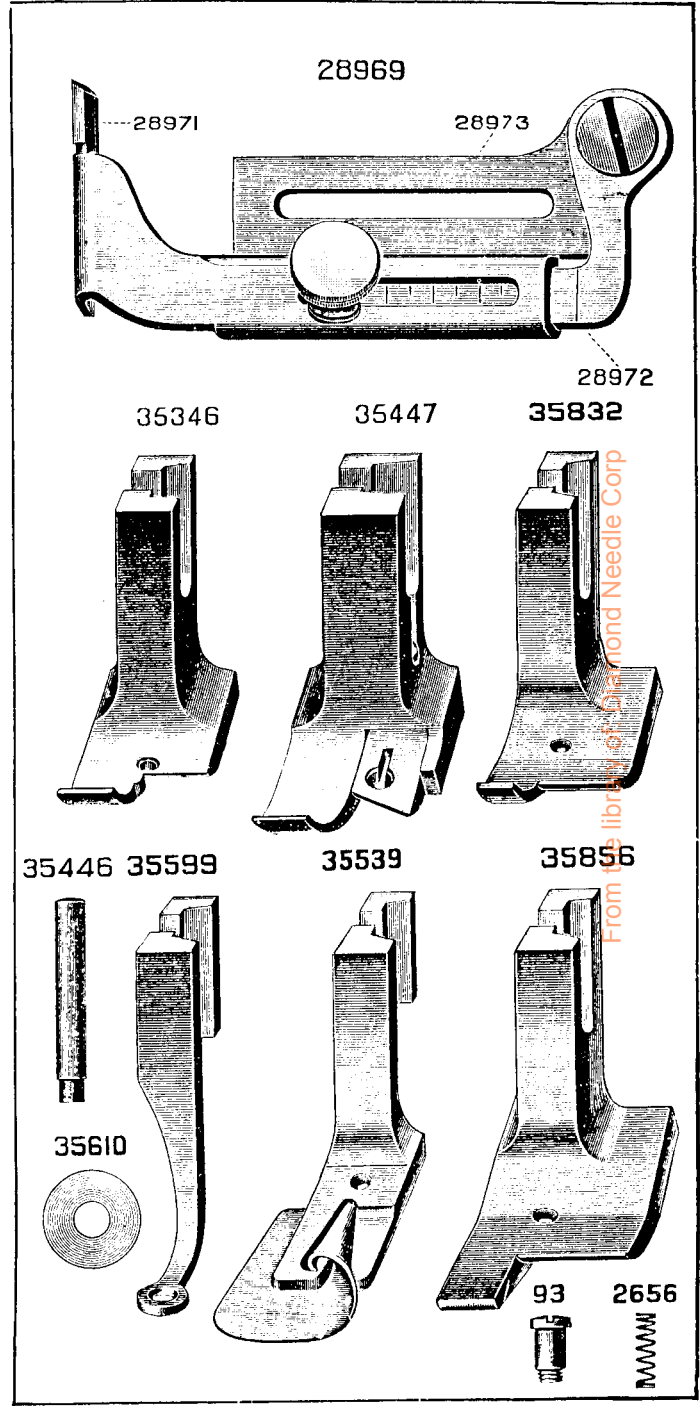
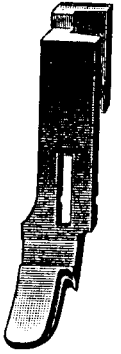
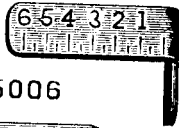


PLATE 2671—FULL SIZE

35001 28951 2653 28952 26092



35005



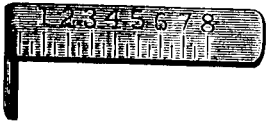
35002



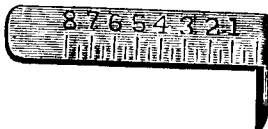
35006



35003



35004



35134



35135



35136



36696

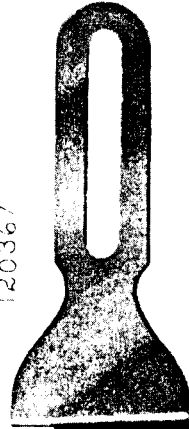


337



PLATE 2672—FULL SIZE

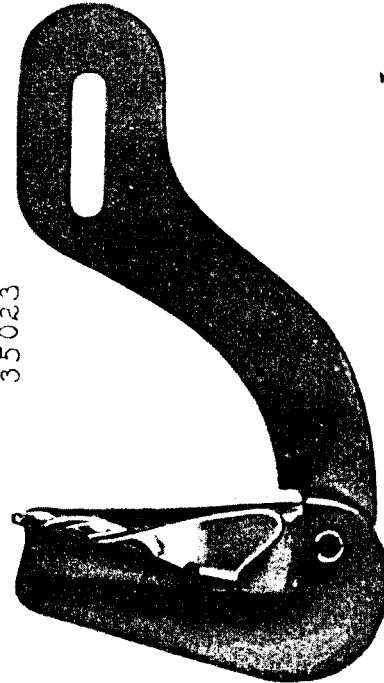
120367



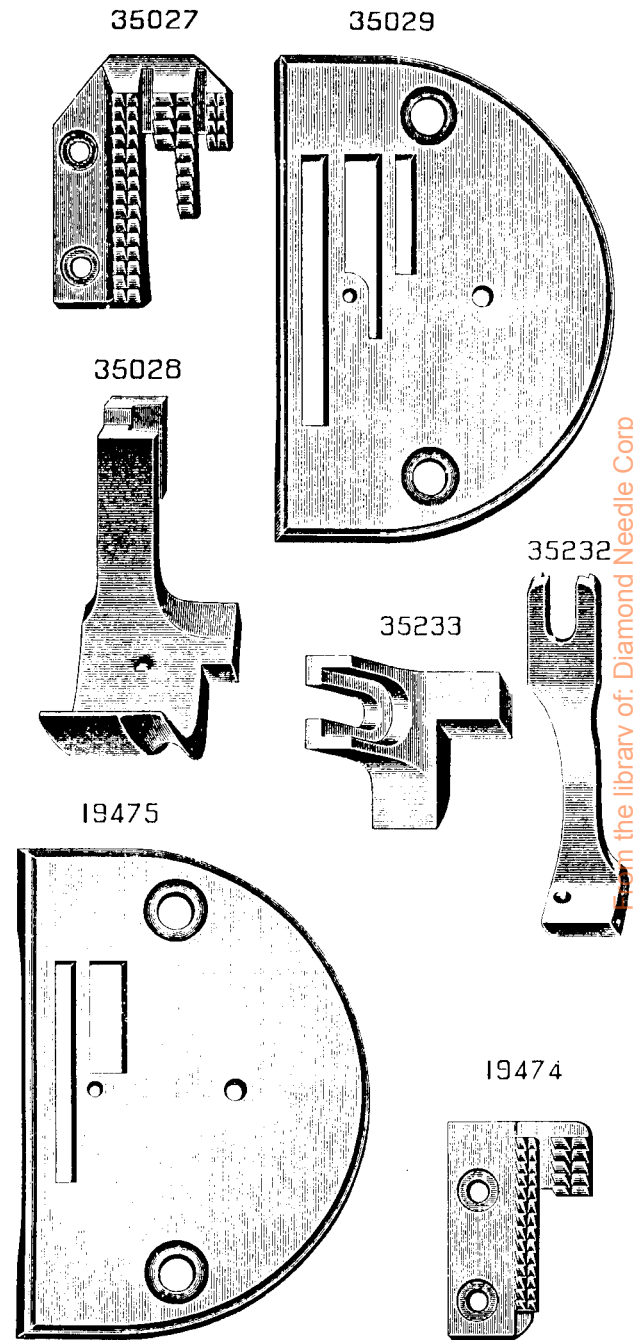
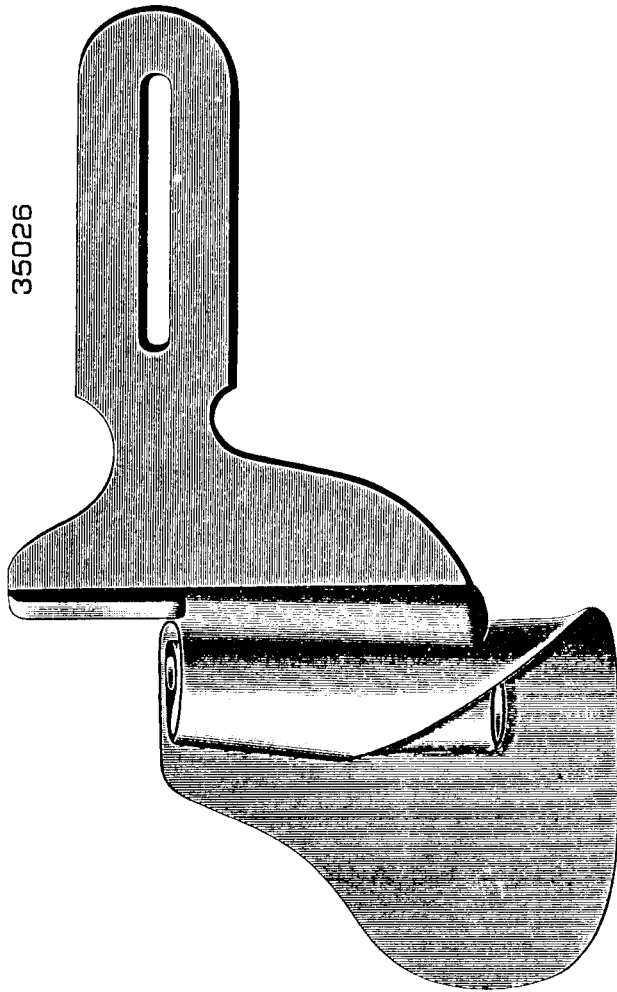
120452



35023



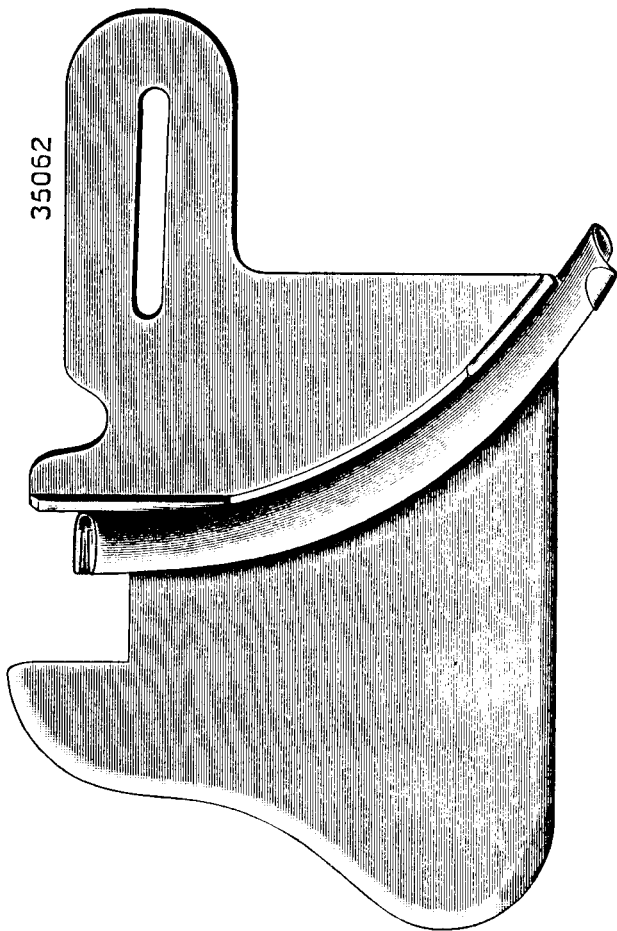
From the library of: Diamond Needle Corp



from the library of: Diamond Needle Corp

PLATE 2676—FULL SIZE

35062



35063

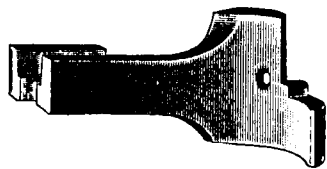


PLATE 2677—FULL SIZE

35065

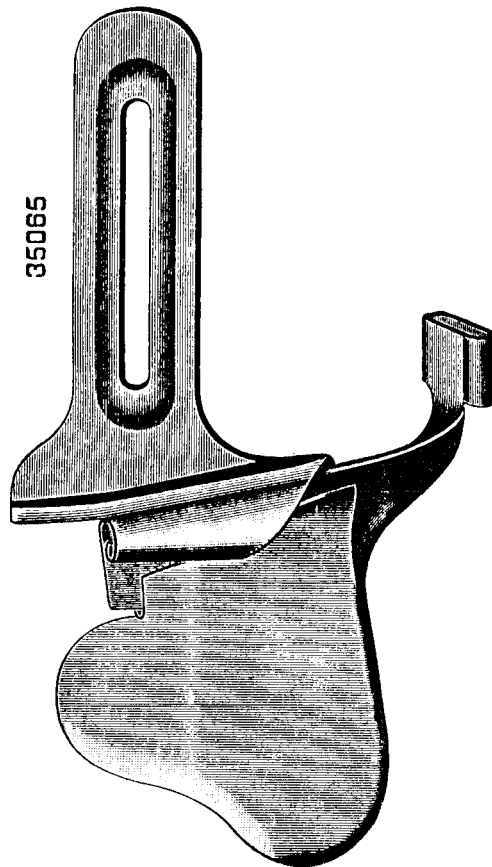


PLATE 2678—FULL SIZE

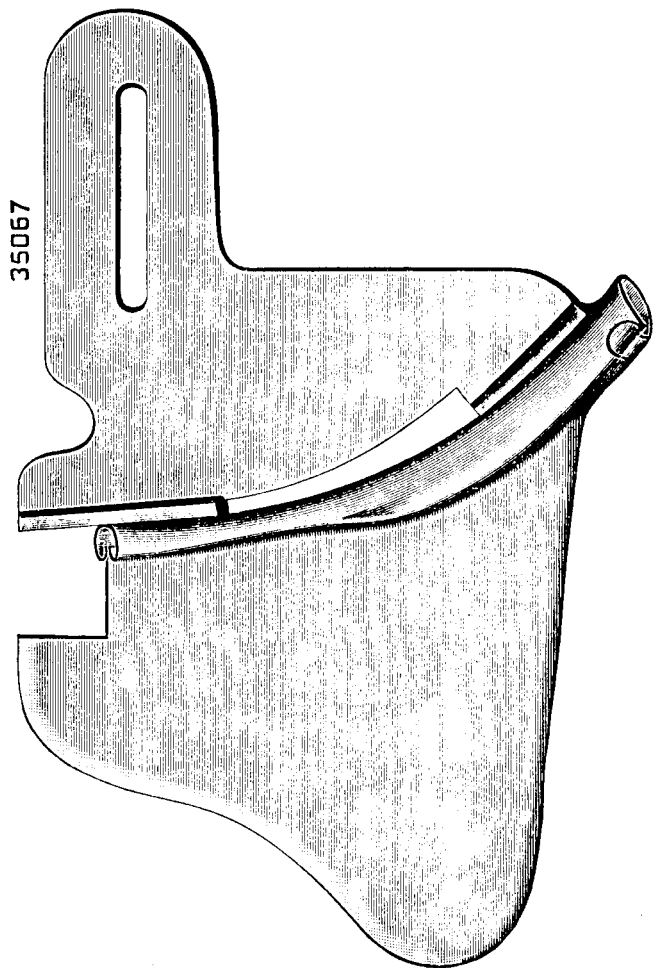


PLATE 2680—FULL SIZE

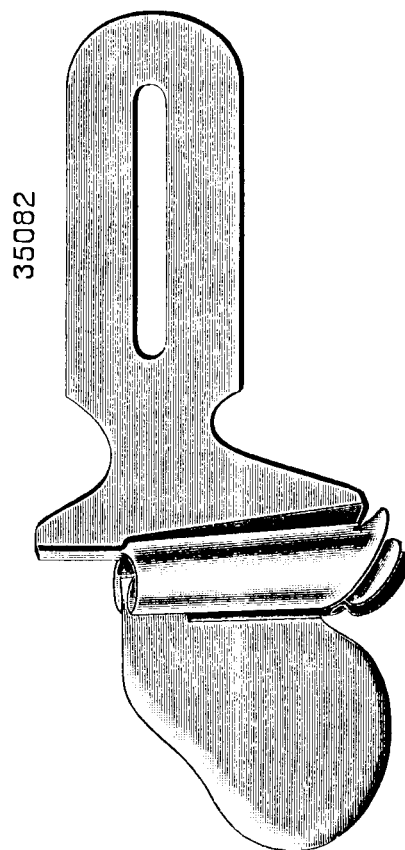
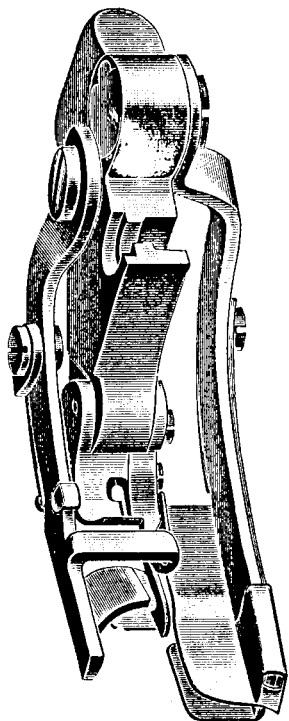
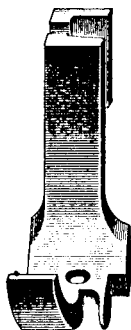


PLATE 2682—FULL SIZE

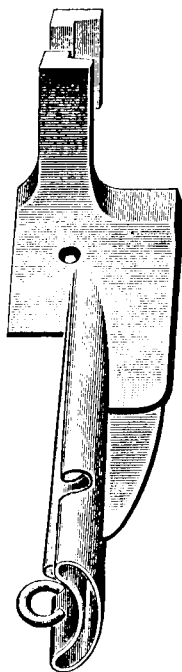
35100



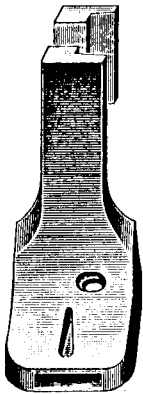
35066



35129



35172



35184

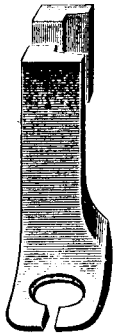
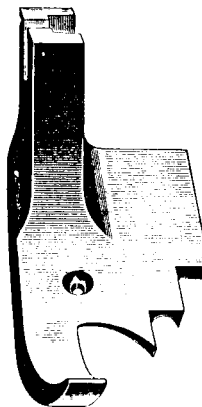


PLATE 2683—FULL SIZE

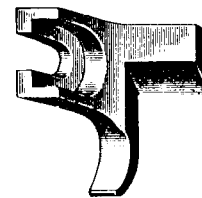
35183



35210



35211



35231

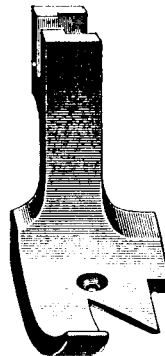


PLATE 2684—ONE-HALF SIZE

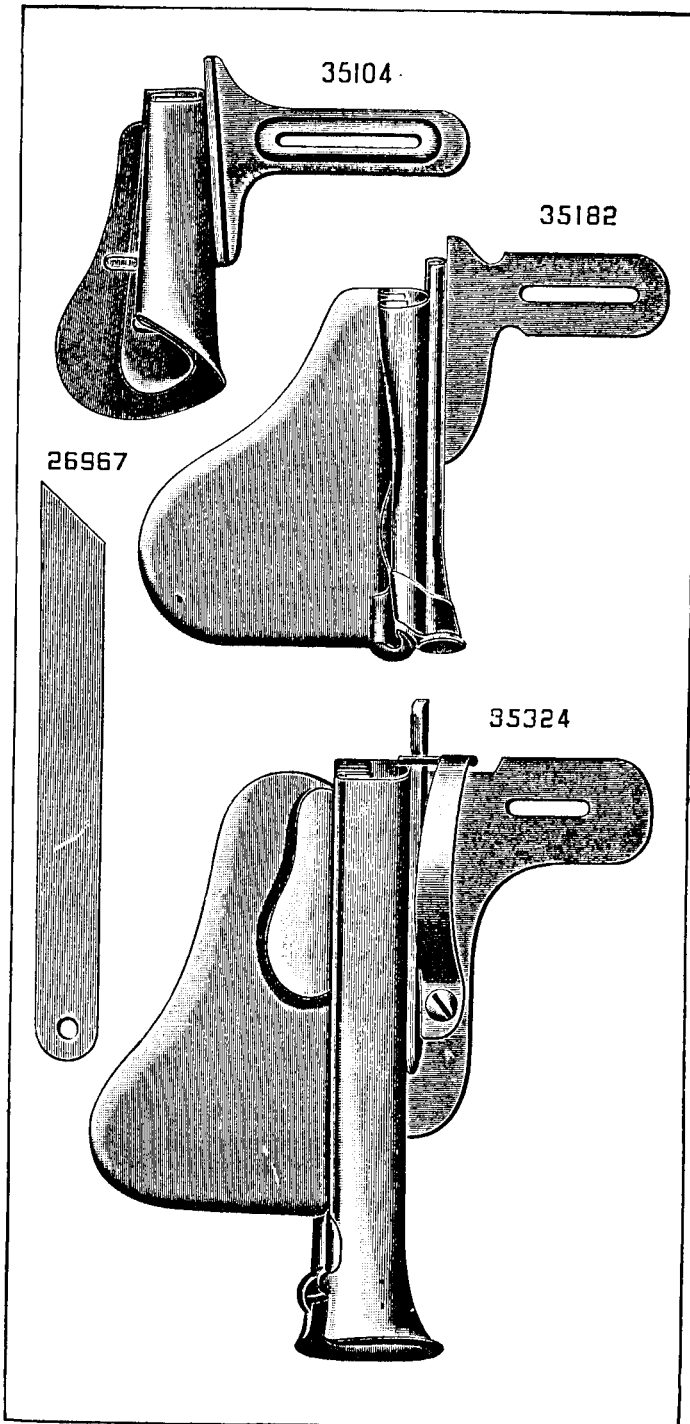


PLATE 2687—ONE-HALF SIZE

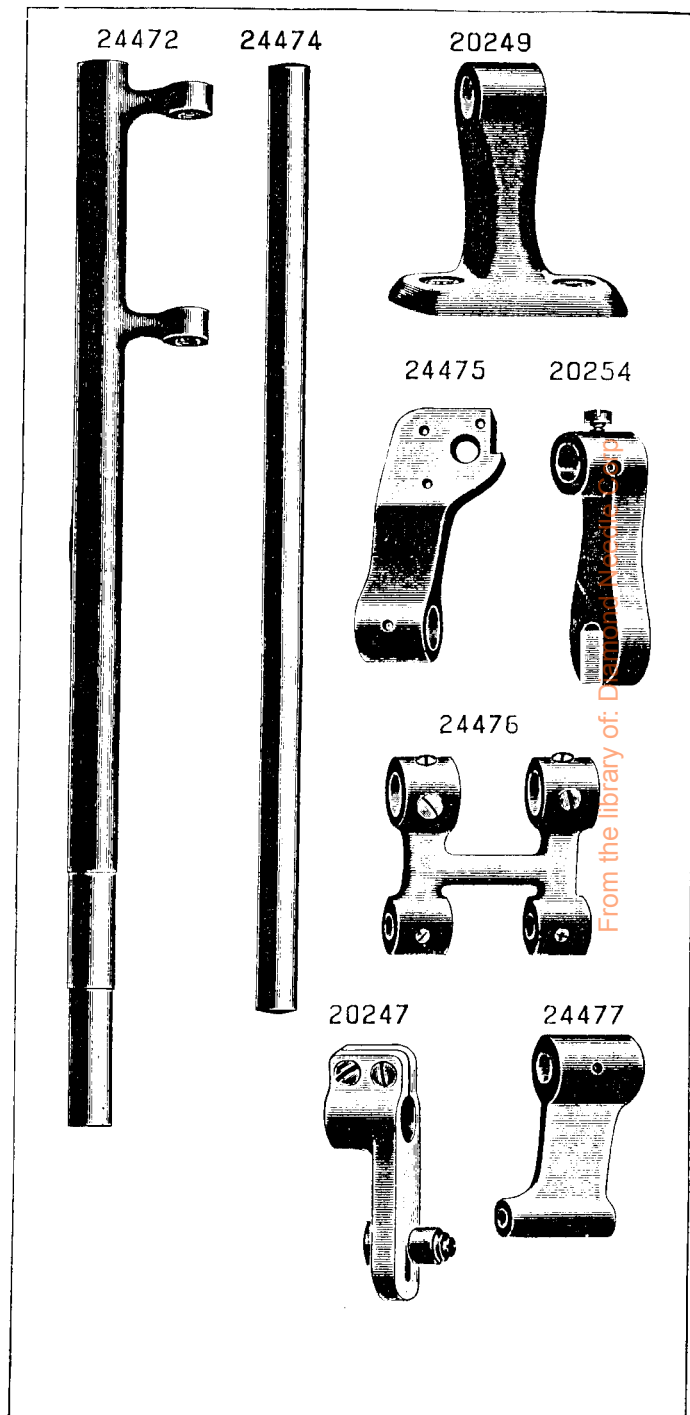


PLATE 2688—FULL SIZE

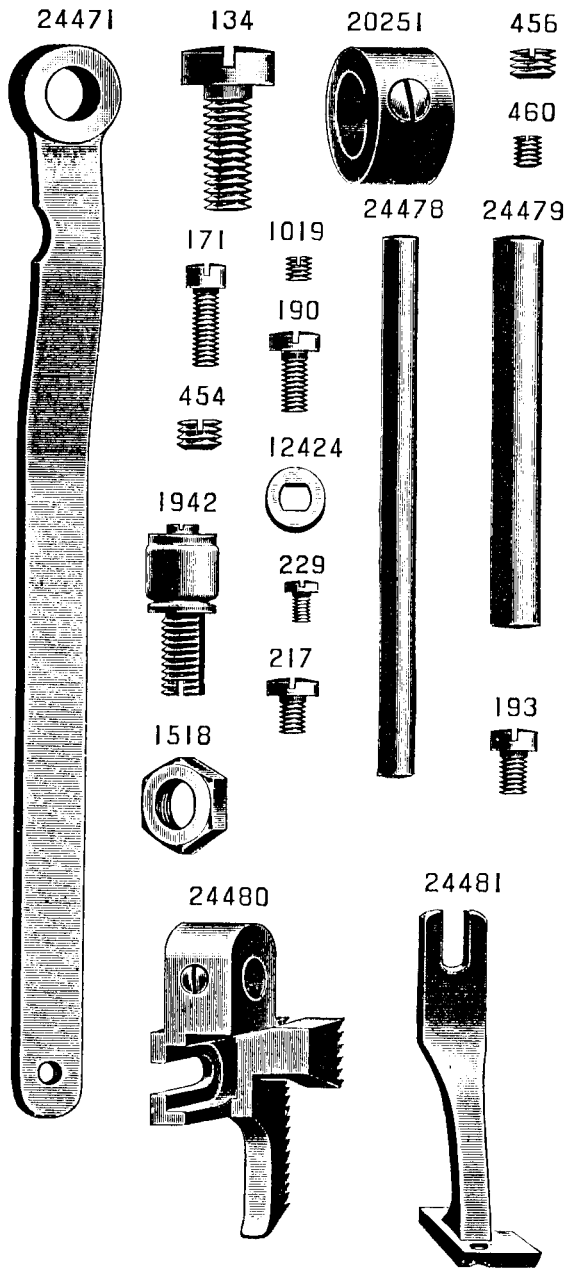
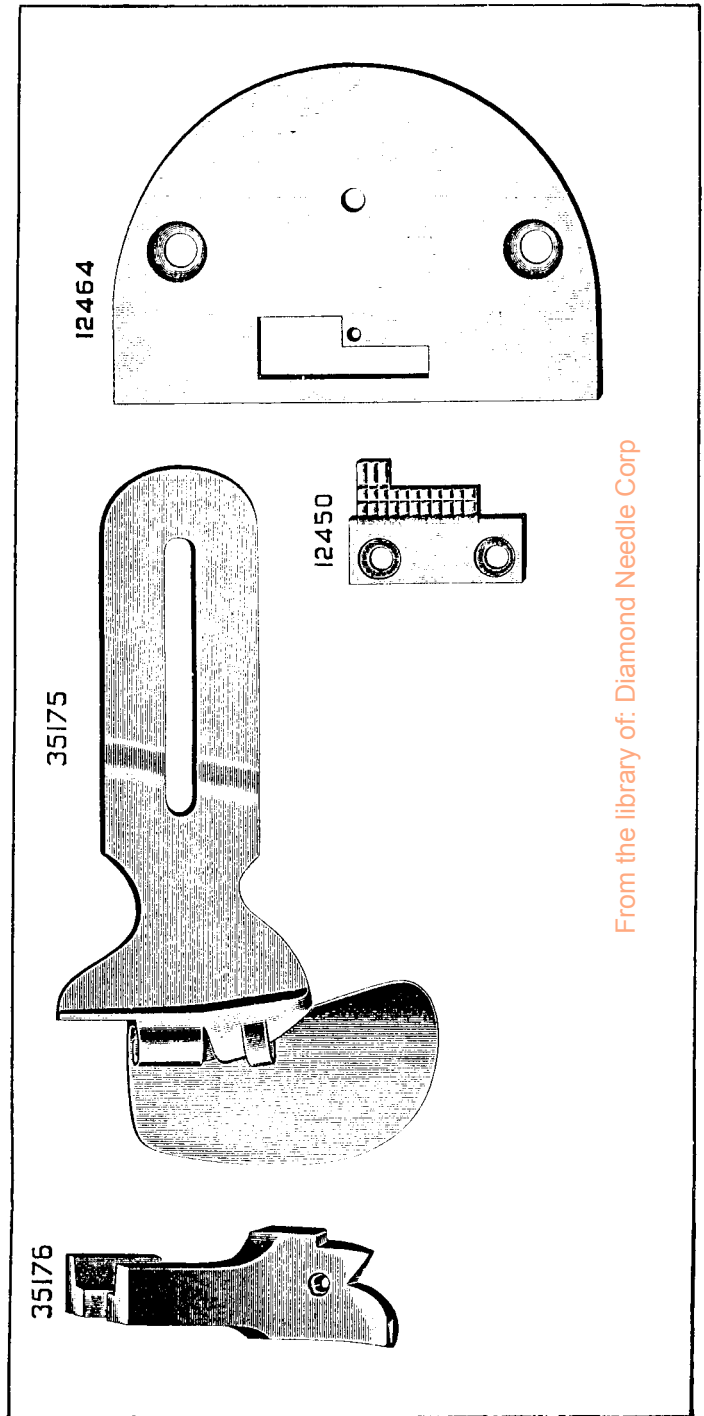
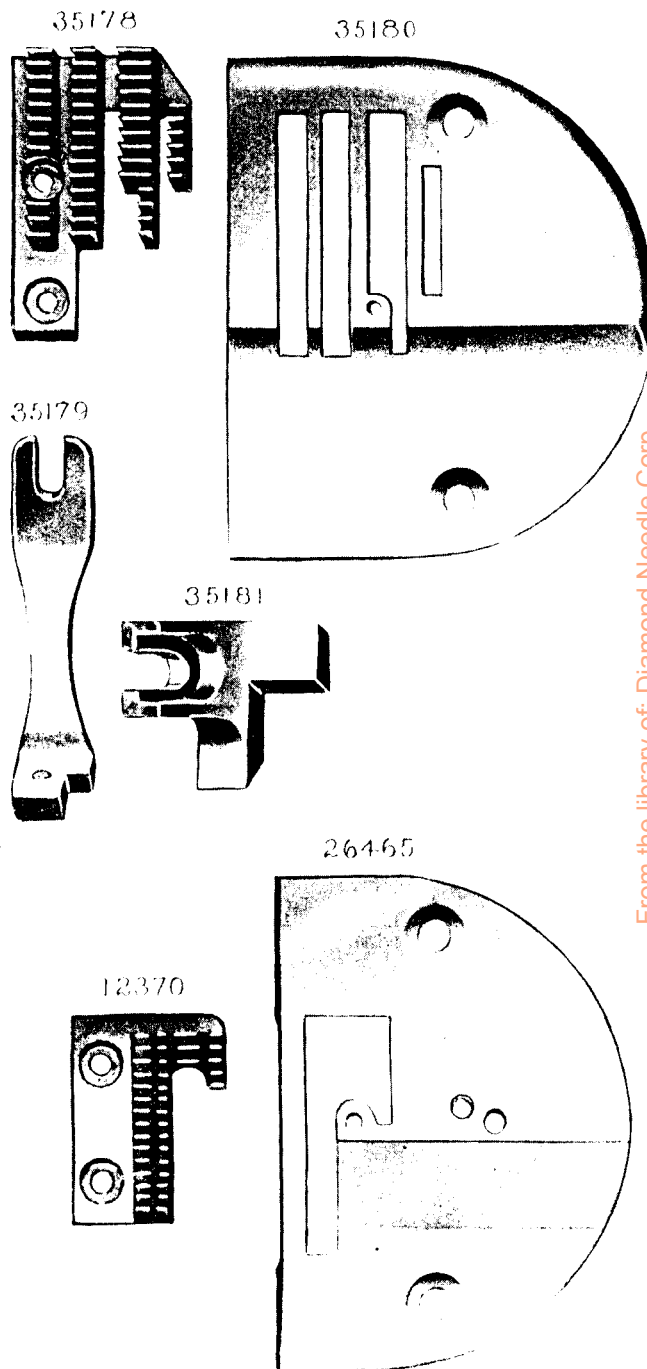
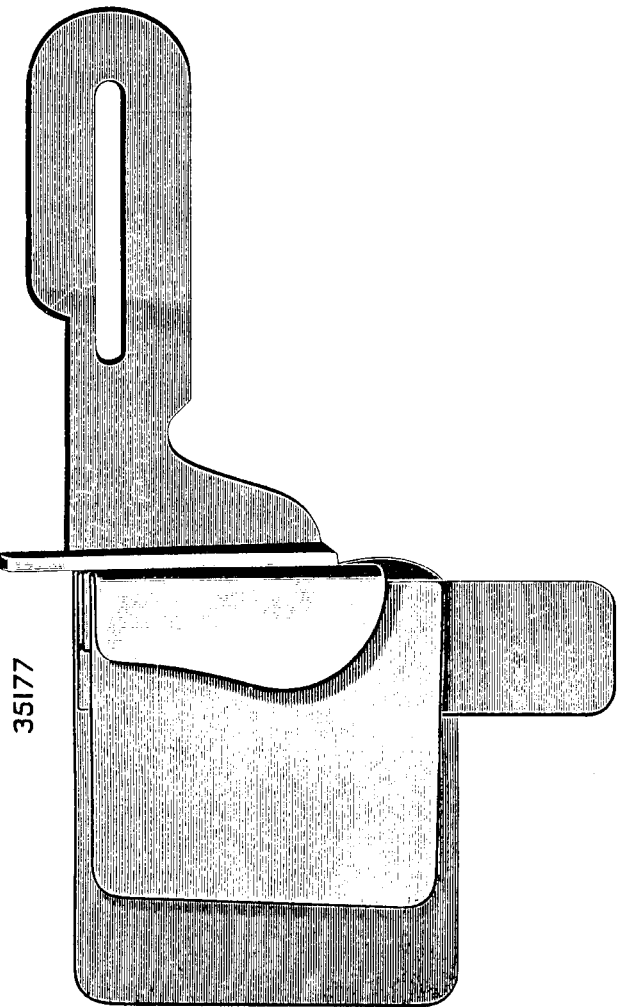
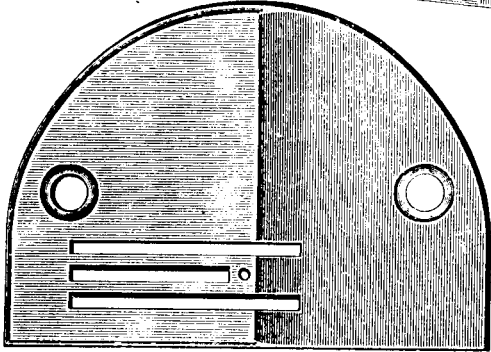


PLATE 2690—FULL SIZE

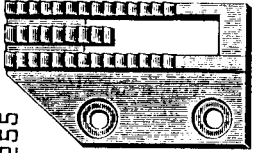




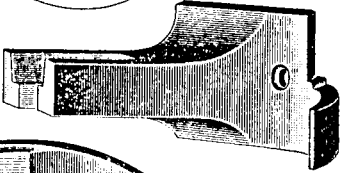
35256



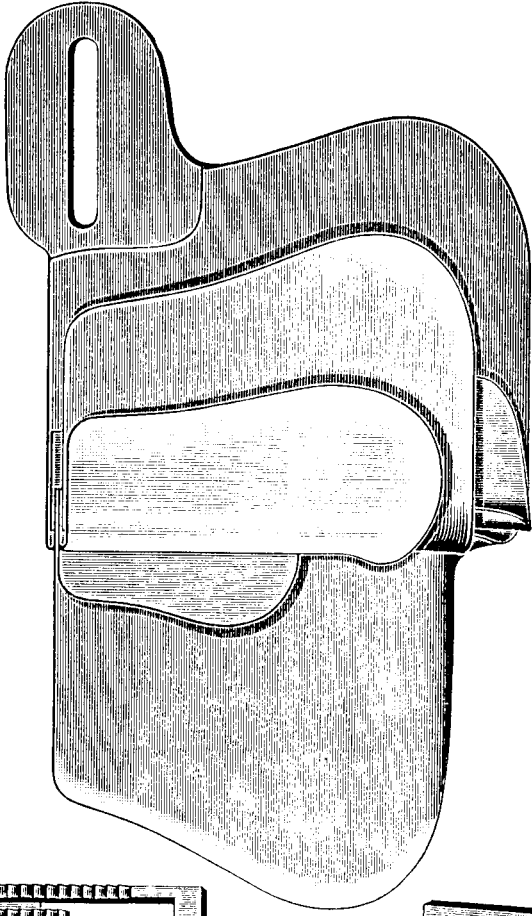
35255



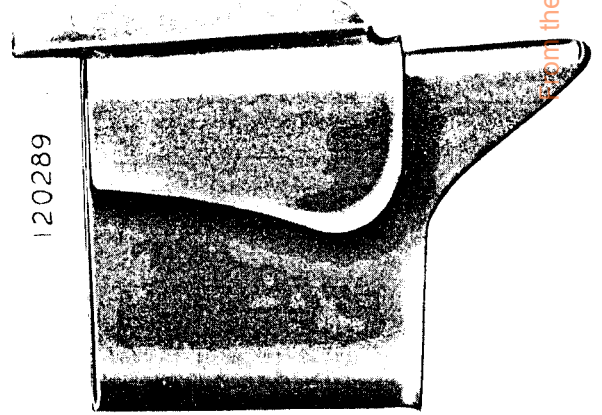
35254



35253



120289



35166

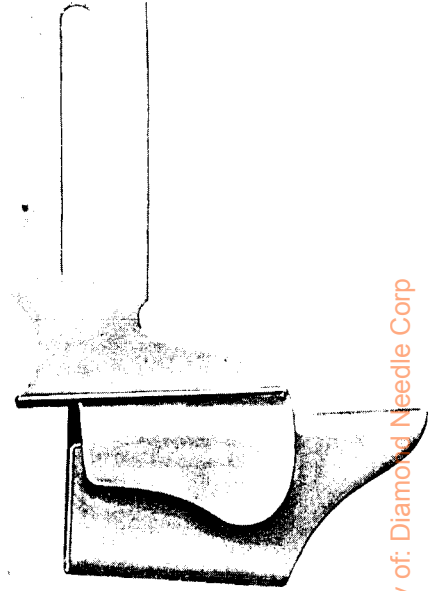
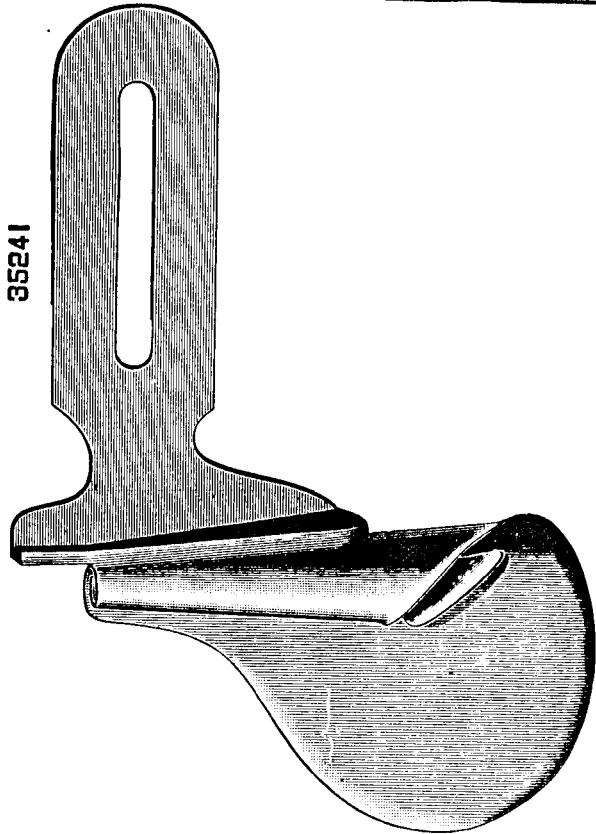
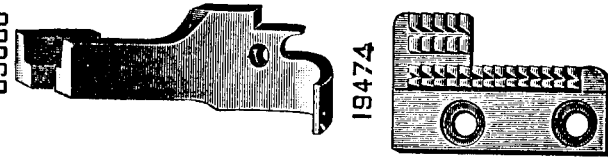


PLATE 2695—FULL SIZE

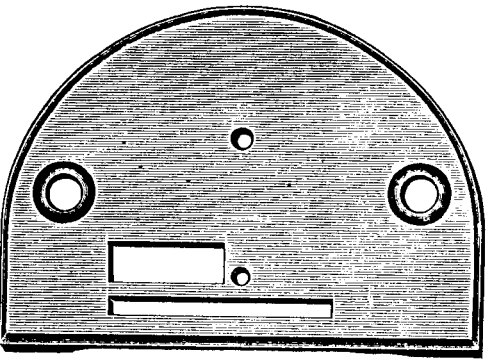


35241



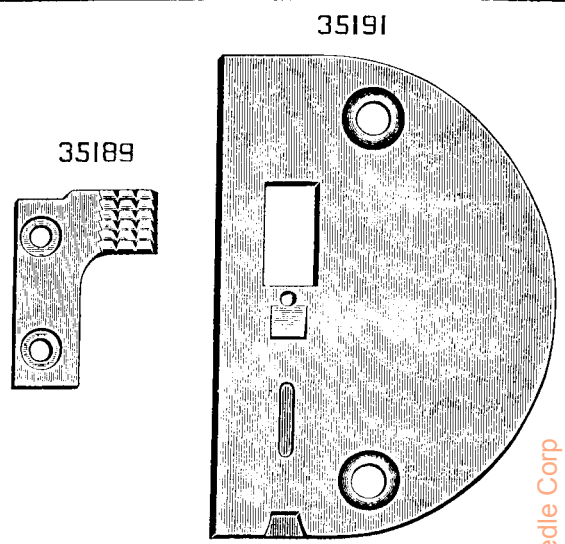
35066

19474



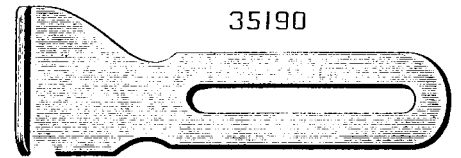
19475

PLATE 2697—FULL SIZE

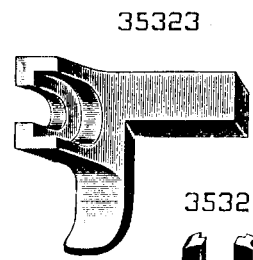


35189

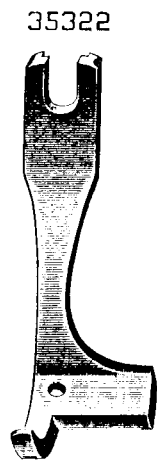
35191



35190



35323



35322

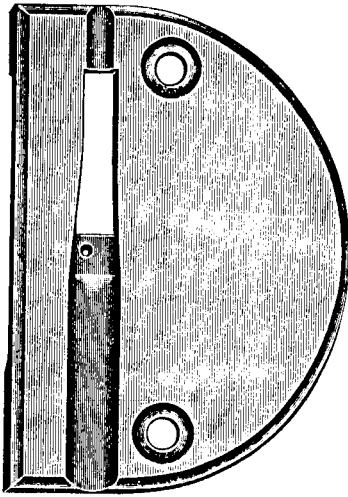
From the library of: Diamond Needle Corp

PLATE 2698—FULL SIZE

35243



35244



35242

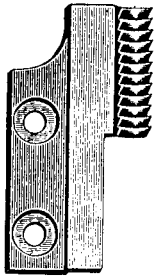
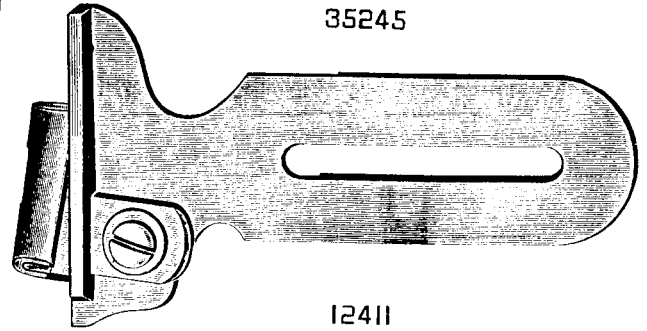
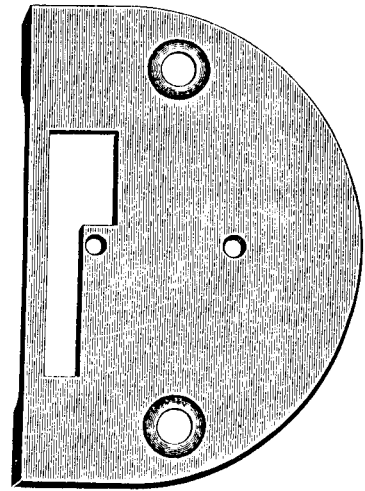


PLATE 2699—FULL SIZE

35245



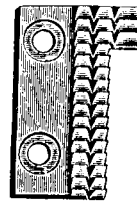
12411



35246



12457



12369

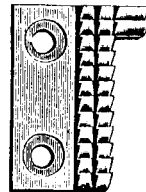


PLATE 2782—FULL SIZE

28903

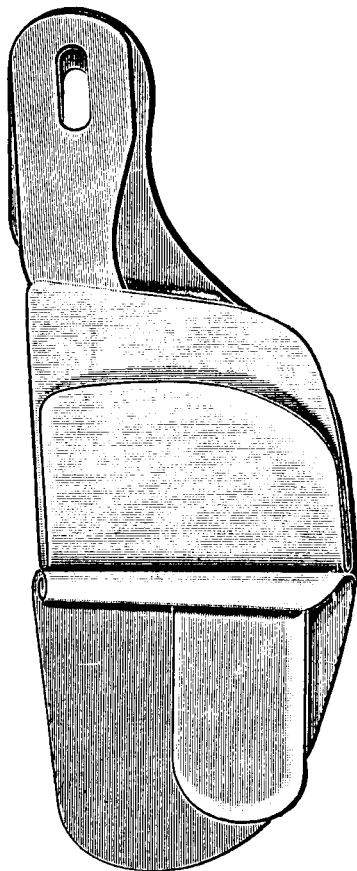


PLATE 2836—ONE-FOURTH SIZE

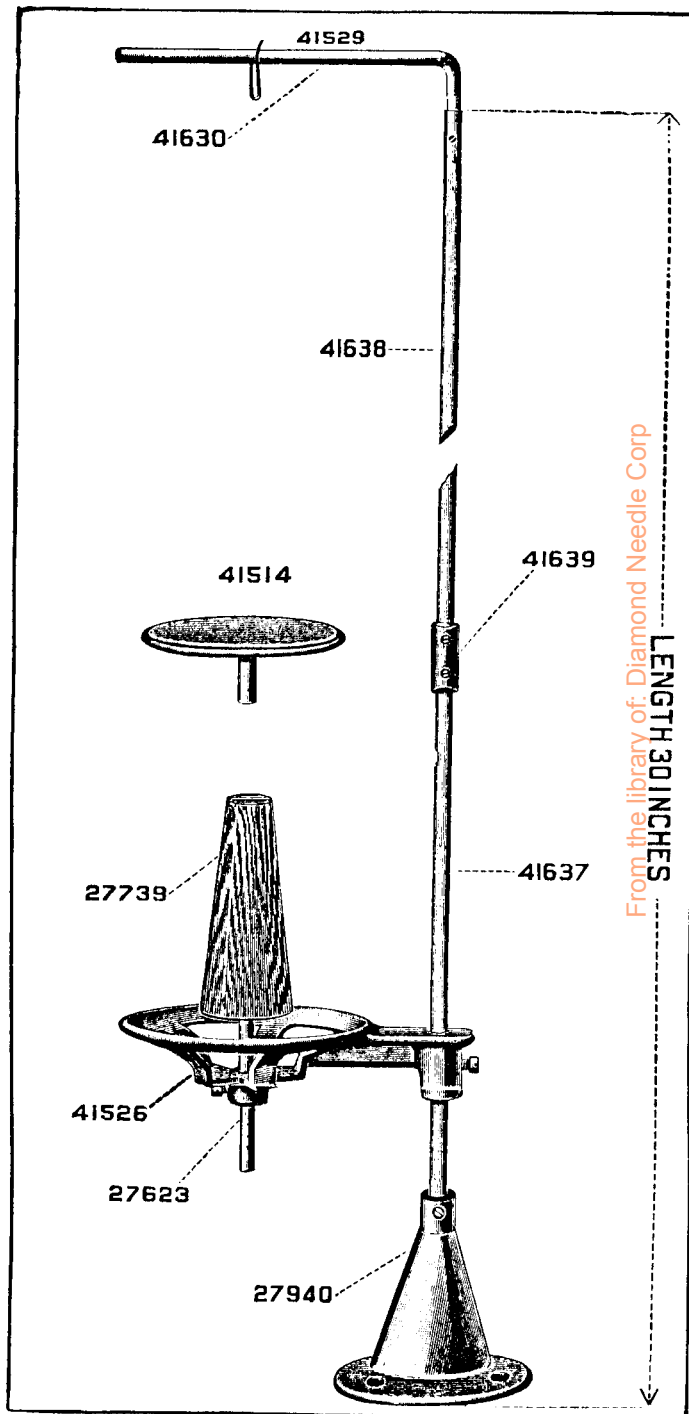


PLATE 2837—ONE-FOURTH SIZE

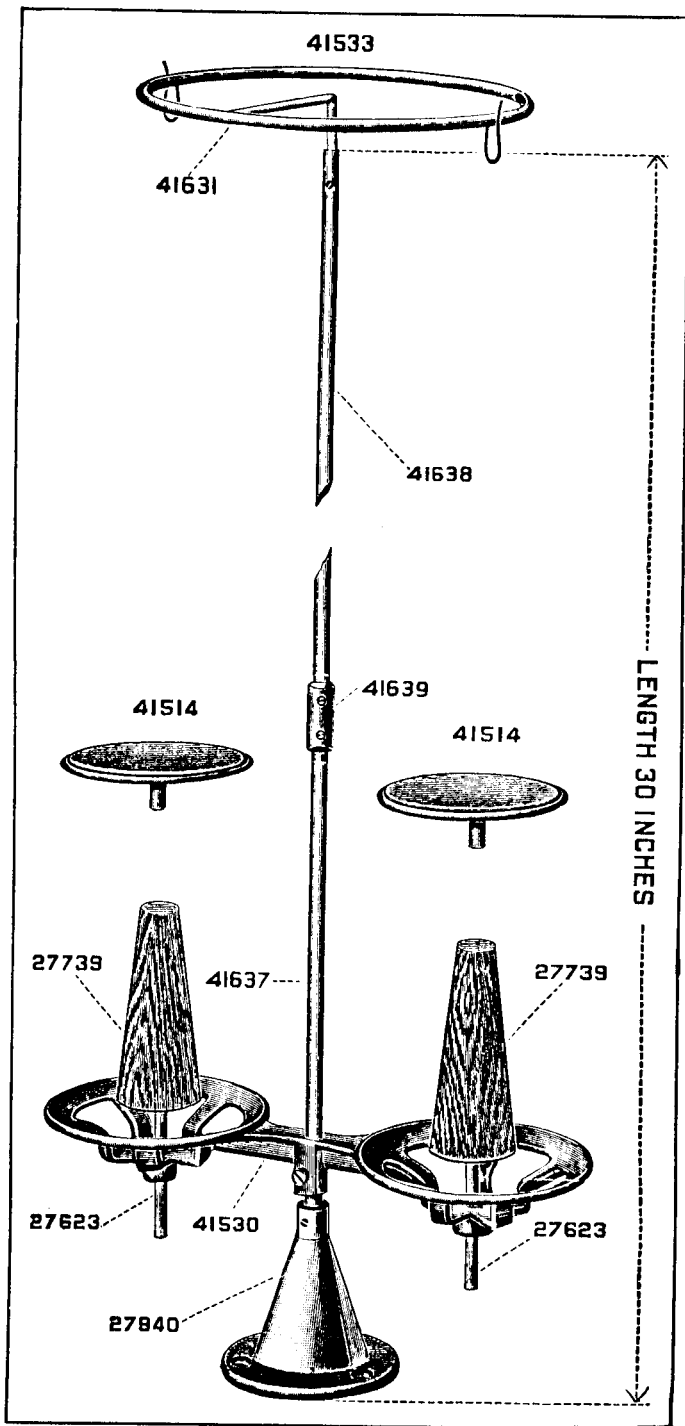


PLATE 3469—ONE-FOURTH SIZE

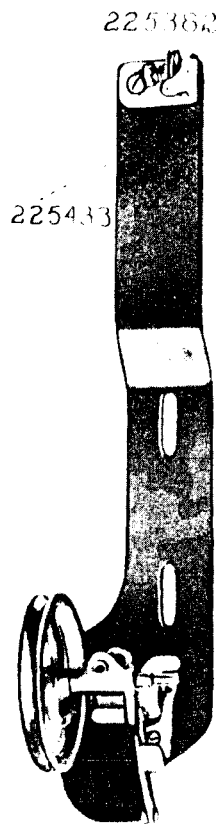
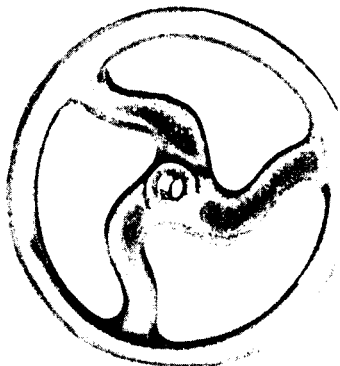


PLATE 3470—ONE-HALF SIZE

202473



225453



225381

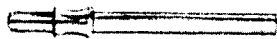
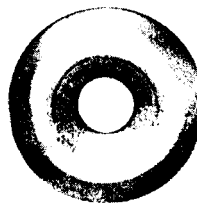


PLATE 3471—FULL SIZE

2102



202407



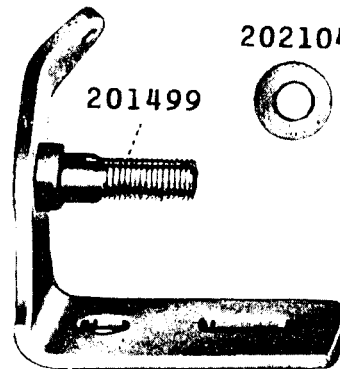
201572



200082 202478 200299



225461



202104



225459



225460



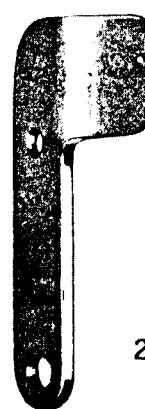
200056 200380



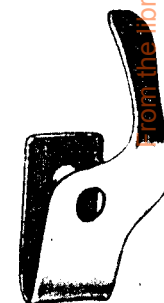
225455 225454



225458



225444



225456



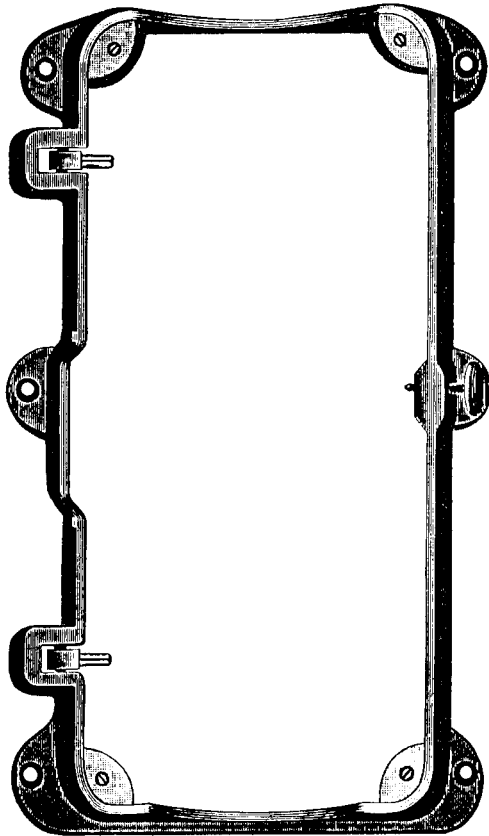
202277 225438



From the Library of: Diana N. ...

PLATE 3538—ONE-FOURTH SIZE

24108



12242

12242



2778

2777

2763

6337

2766

2765

2770

2767

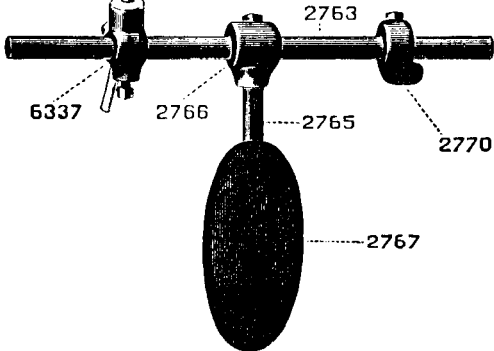
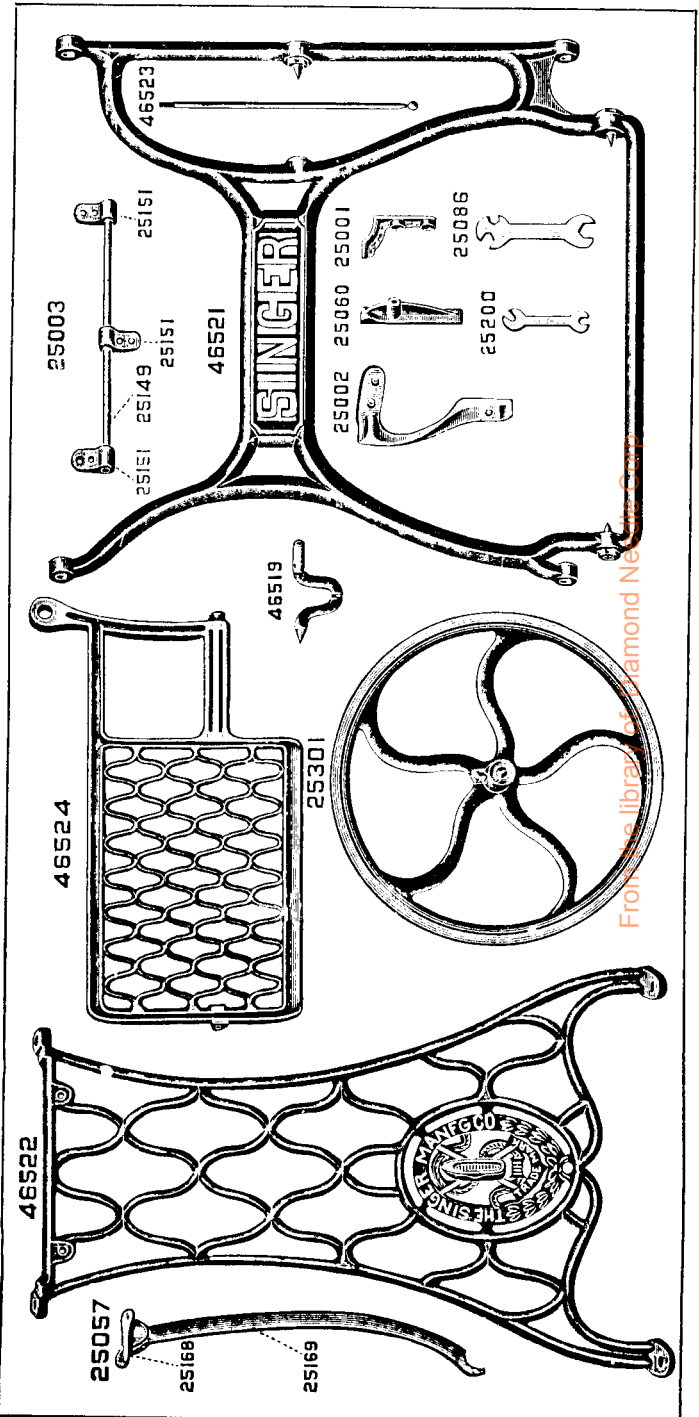


PLATE 3825—ONE-NINTH SIZE



From the Library of Diamond Needle Co.

PLATE 3826—FULL SIZE

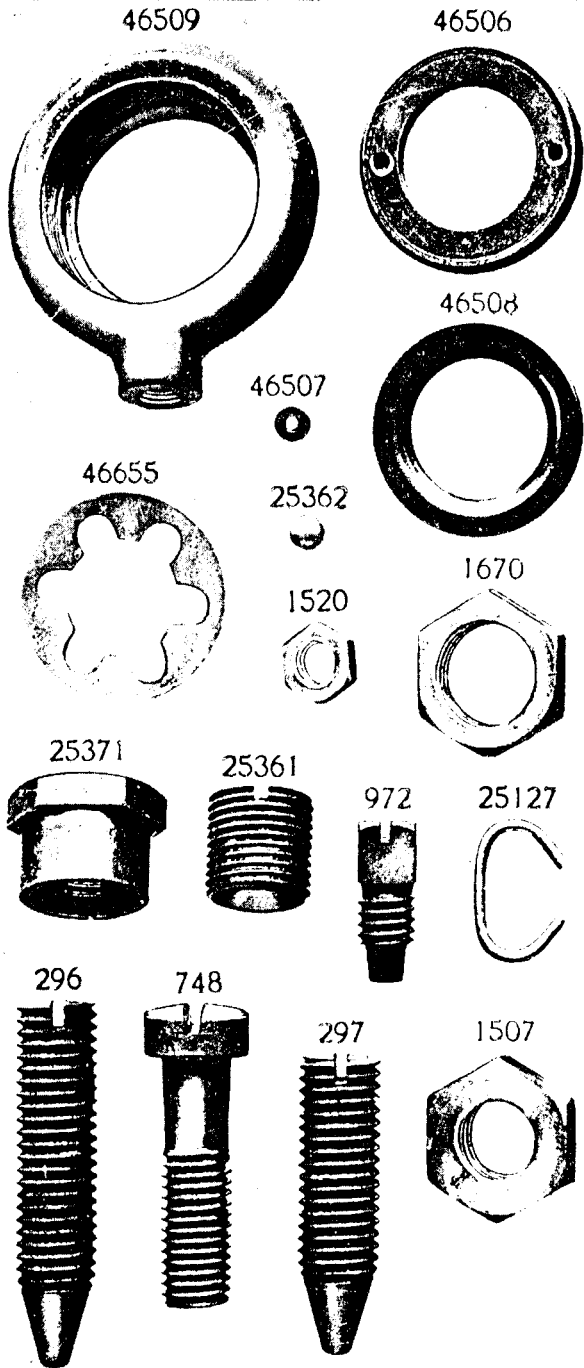
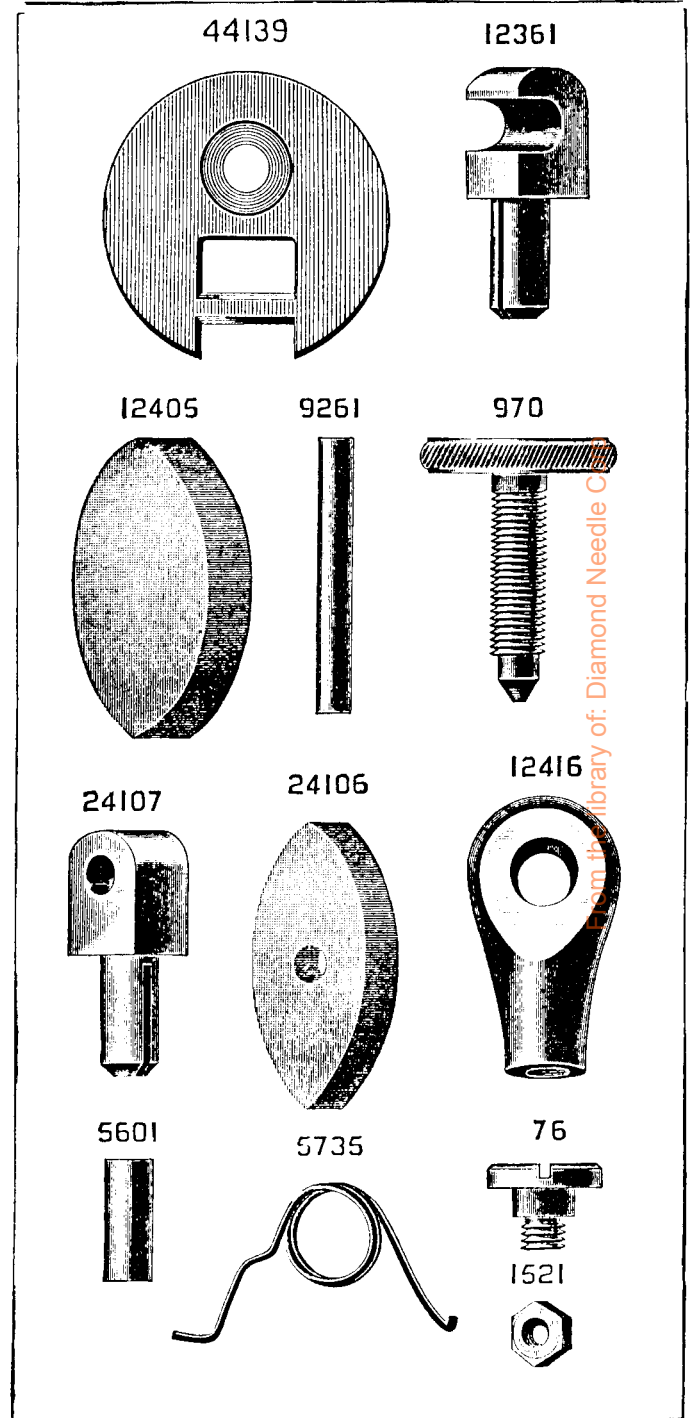


PLATE 4761—FULL SIZE



From the library of: Diamond Needle Co.

PLATE 5643—FULL SIZE

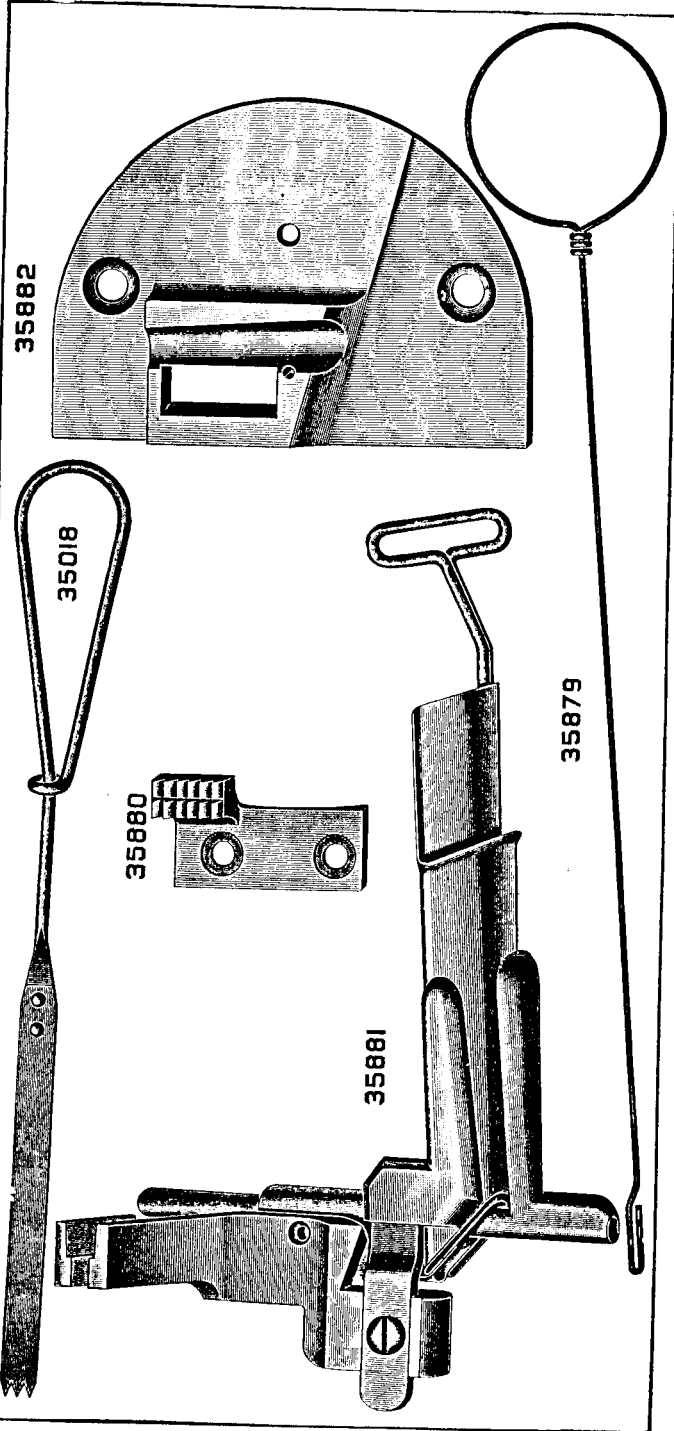


PLATE 5644—FULL SIZE

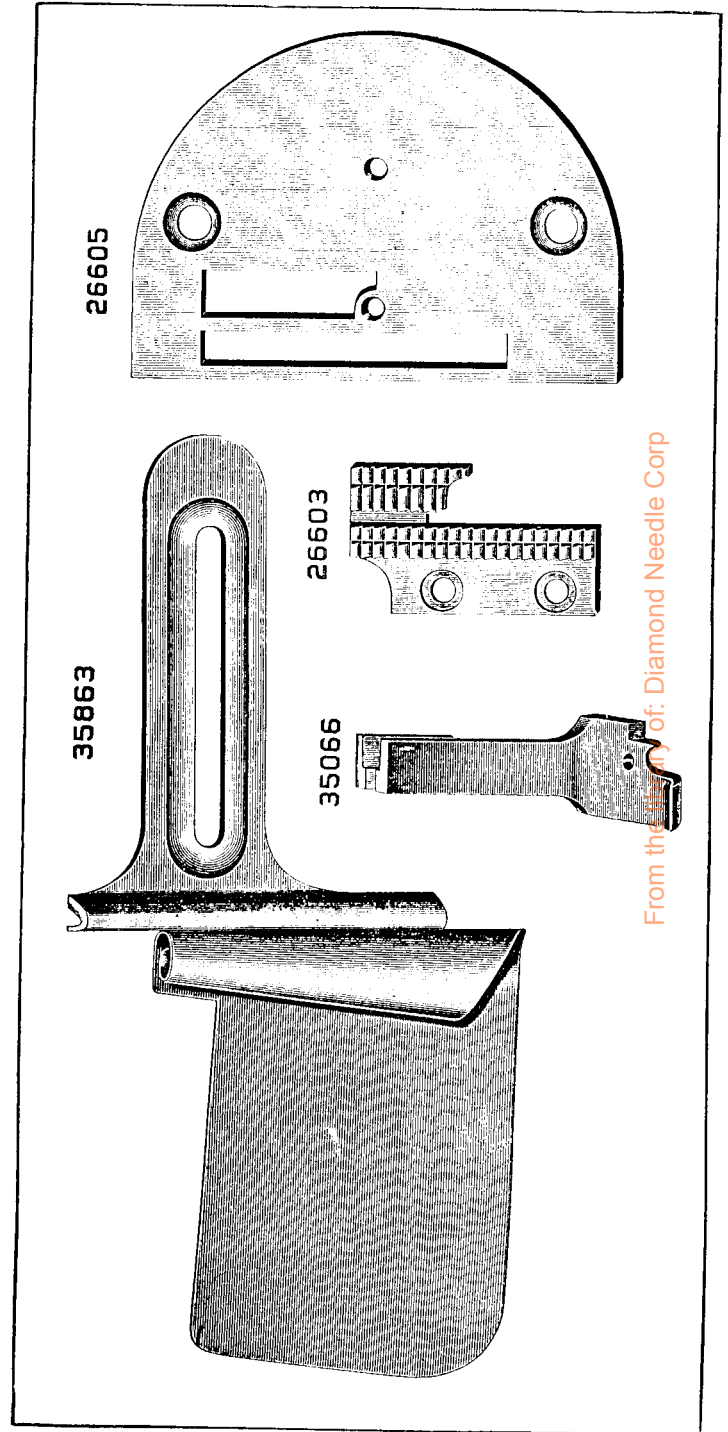
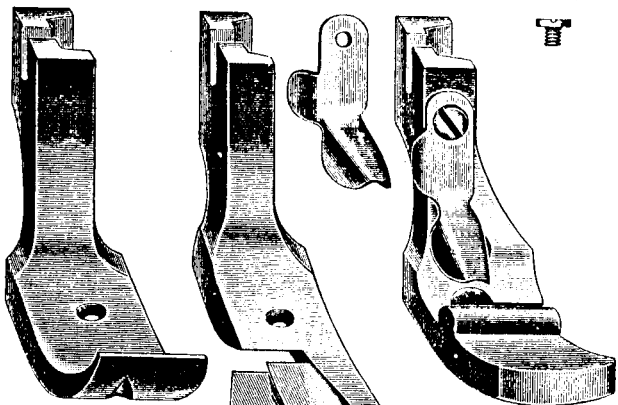


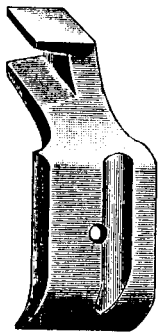
PLATE 5645—FULL SIZE

36069 35995 36023 36022 665



36069

36022



35995

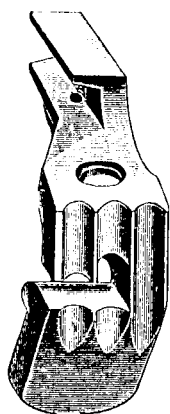
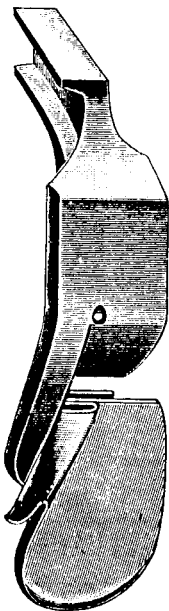
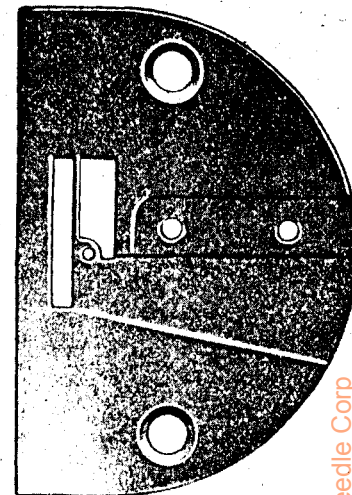
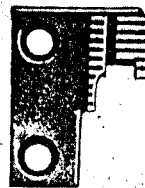


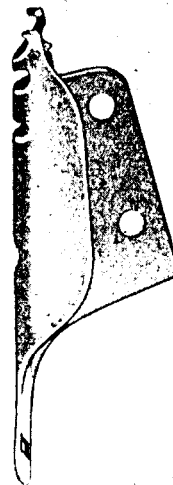
PLATE 5659—FULL SIZE

36705

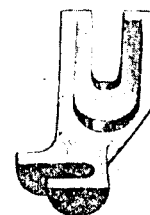
36707



36704



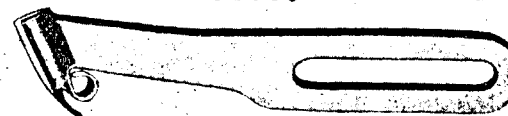
36708



36706



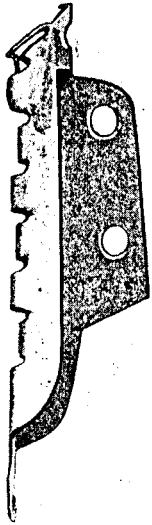
36995



From the library of: Diamond Needle Corp

PLATE 5660—FULL SIZE

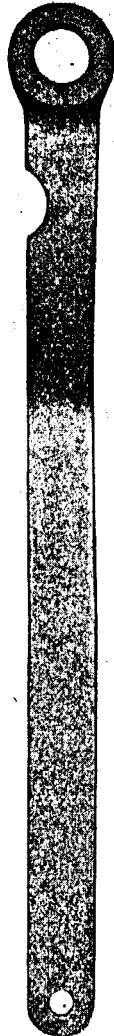
36761



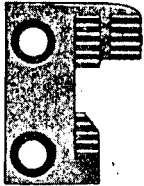
36762



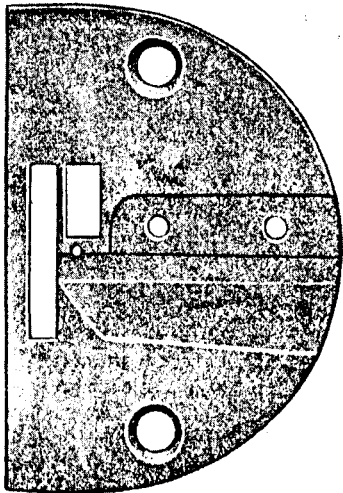
36765



120072



36764



36763



36766

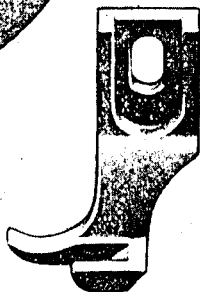
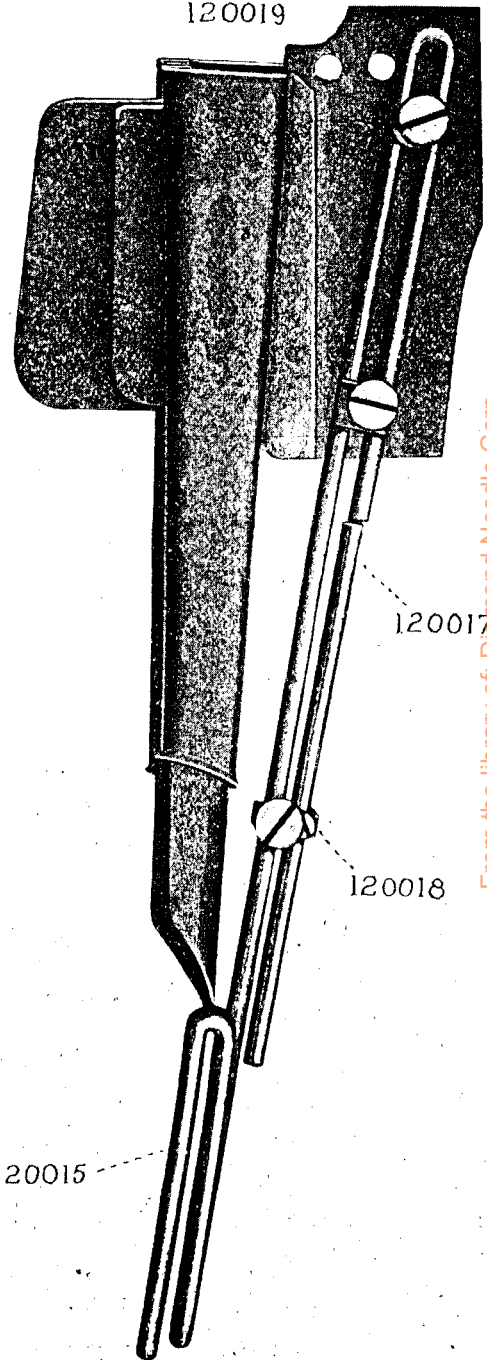


PLATE 5688—ONE-HALF SIZE

120019

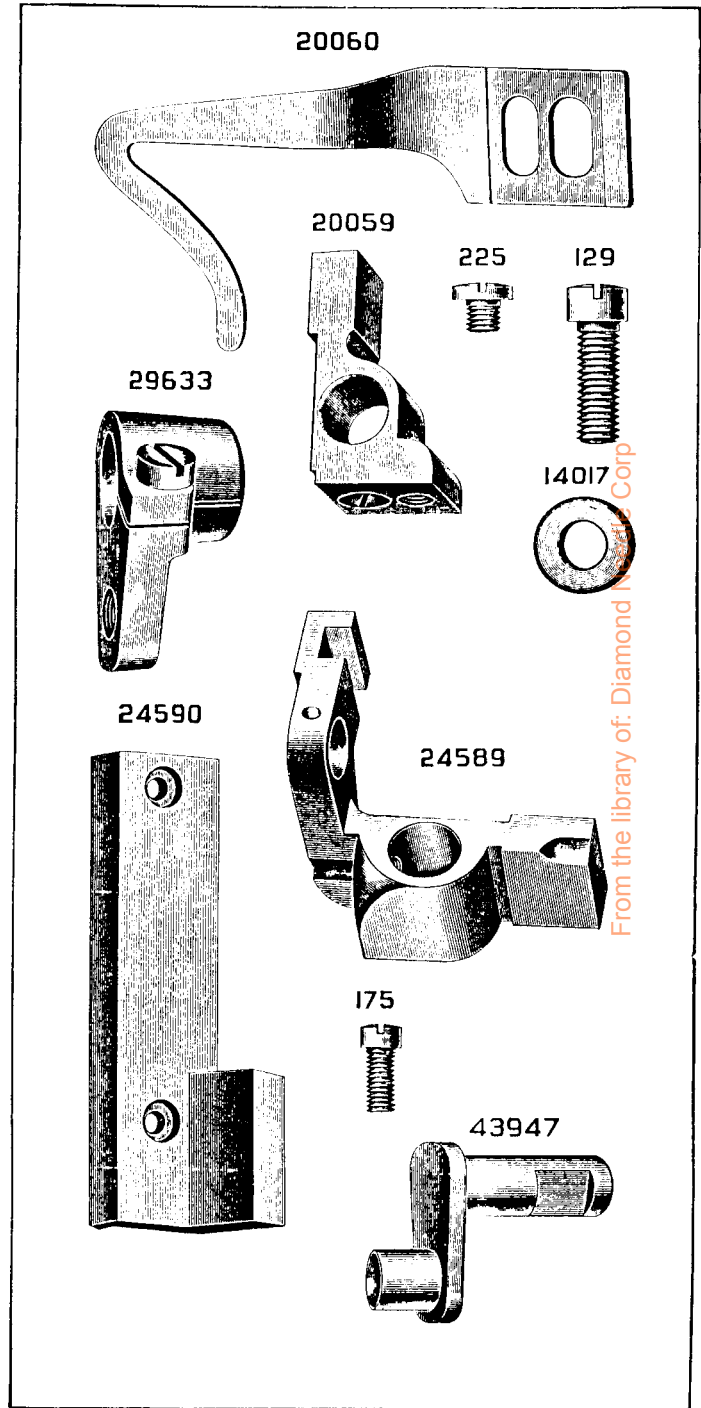
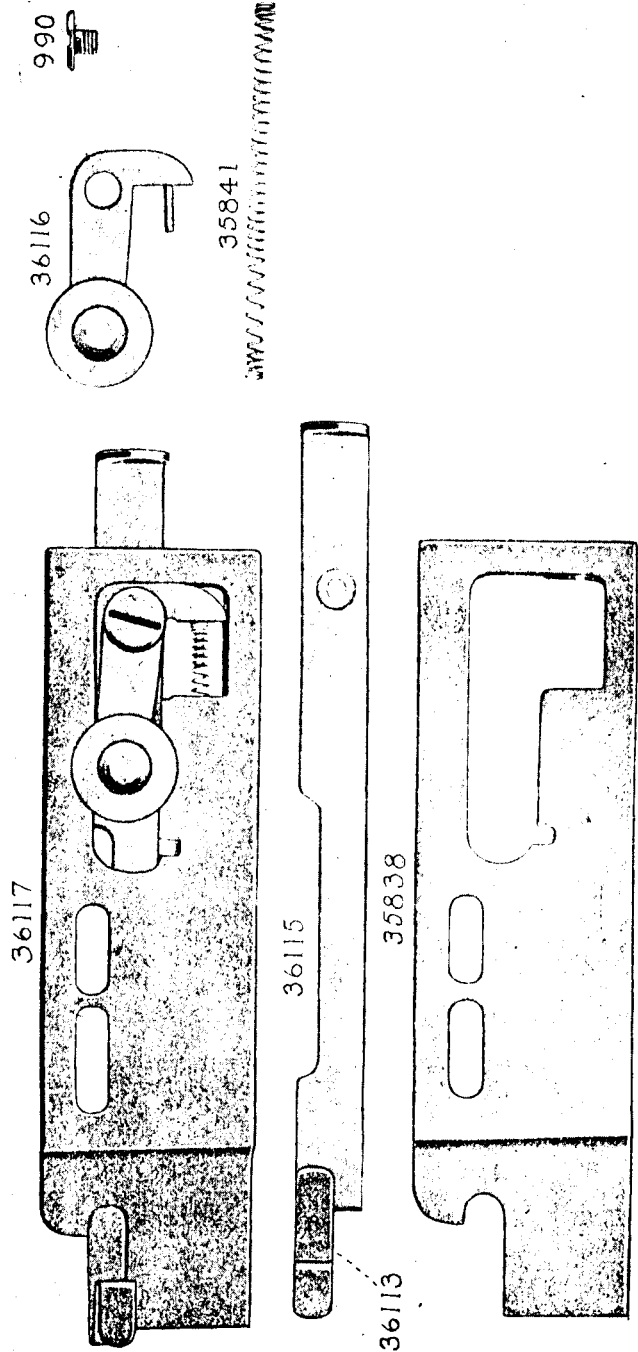


120017

120018

120015

From the library of: Diamond Needle Corp

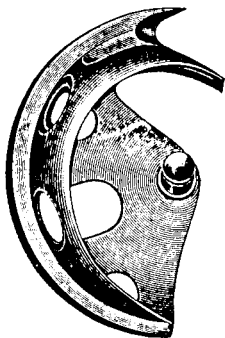
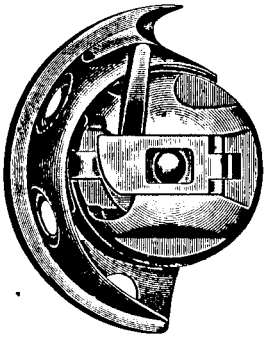


From the library of: Diamond Knives Corp

PLATE 5737—FULL SIZE

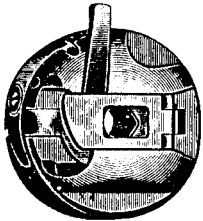
20758

20757



20756

20755 2523 2975 592

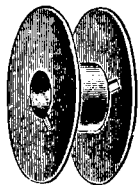


19131

20649

2973

2974 591



20654

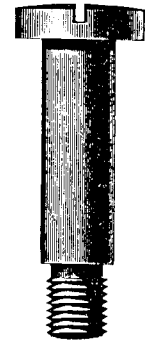
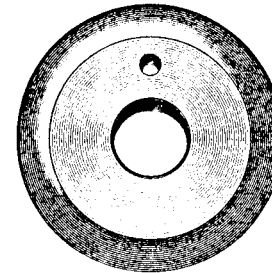
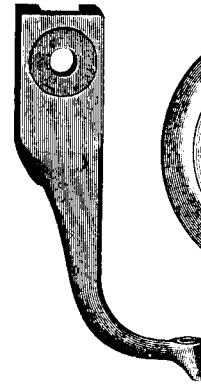


PLATE 5742—FULL SIZE

43805

12315

9



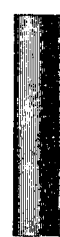
296

28054

41515

25143

811



735

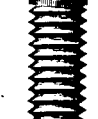
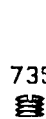
435

69

1149

1500

649



914

1425

940

210

1423

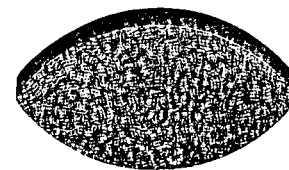
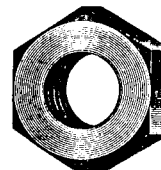
861



1507

20022

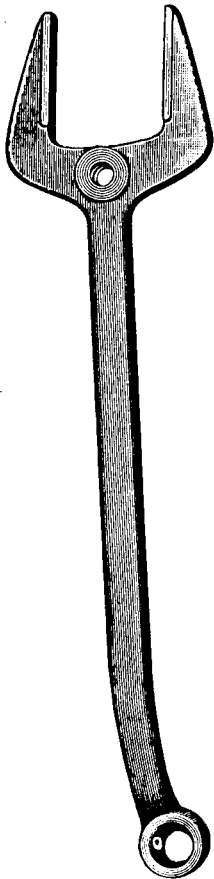
2749



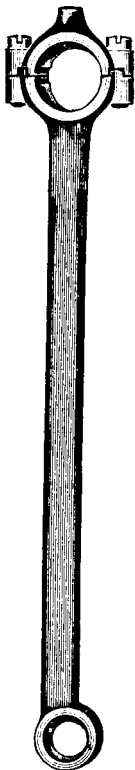
From the library of: Diamond Needle Corp

PLATE 5764—ONE-HALF SIZE

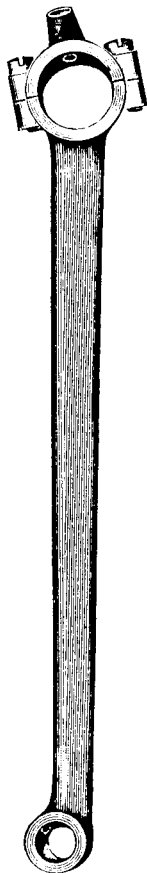
20284



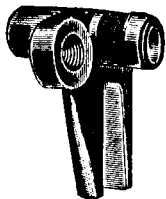
20197



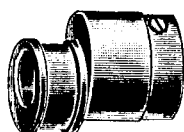
12430



24104



20283



24036



20060

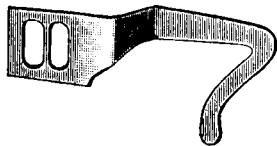
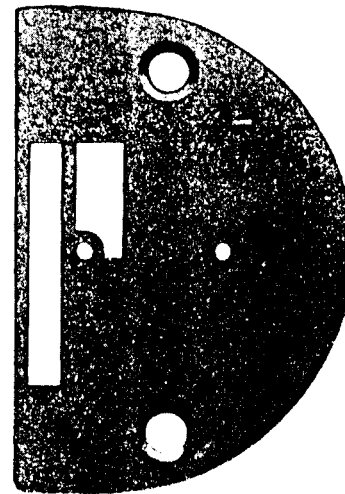


PLATE 5805—FULL SIZE

44137



44136



PLATE 5806—FULL SIZE

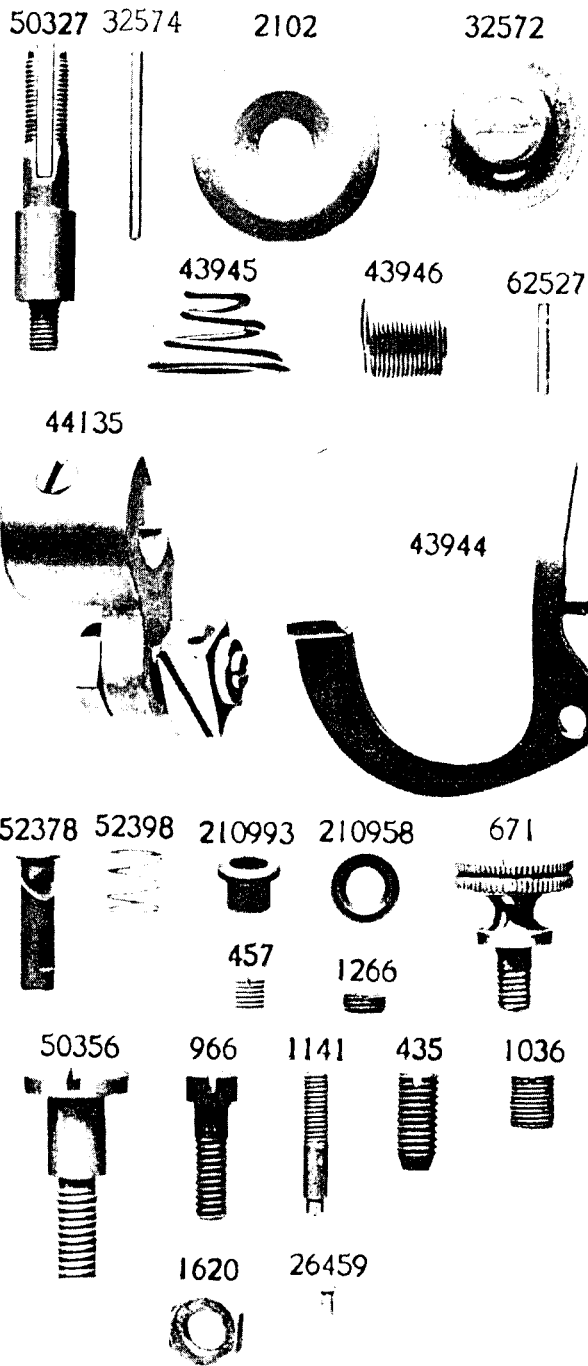
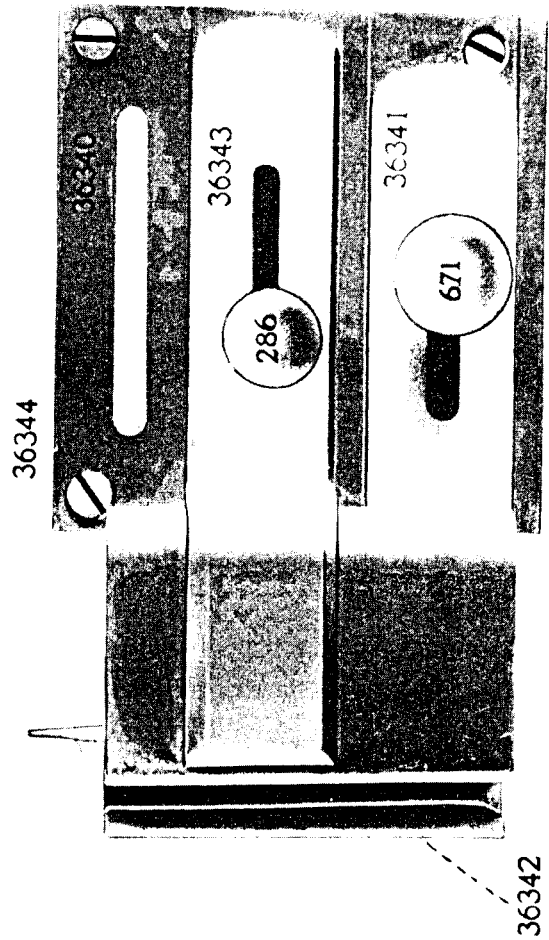


PLATE 5807—FULL SIZE



From the library of: Diamond Needle Corp

PLATE 5808—FULL SIZE

36623



36622



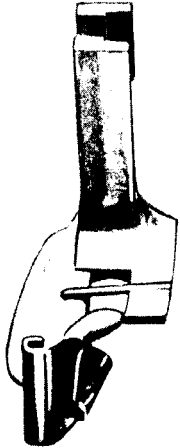
36576



50202



36700



36182

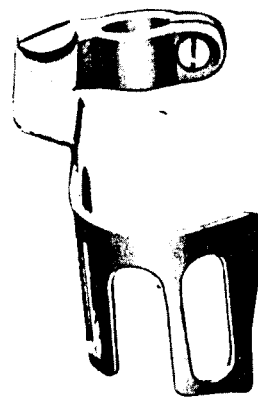


36183

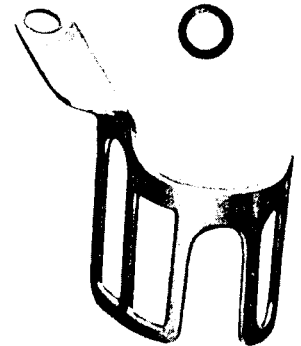


PLATE 5809—FULL SIZE

36821



36818



36819



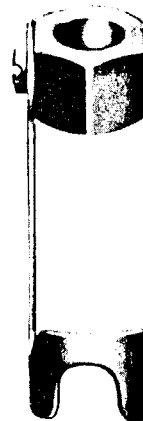
36820



50316 196 50302 236



120498



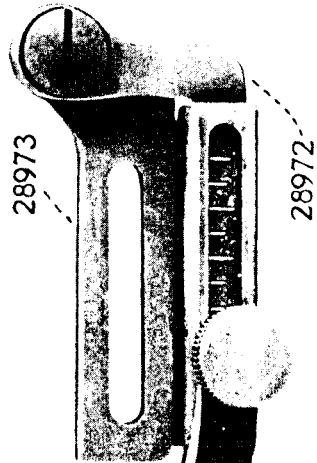
120496



120497



PLATE 5810—FULL SIZE



36293

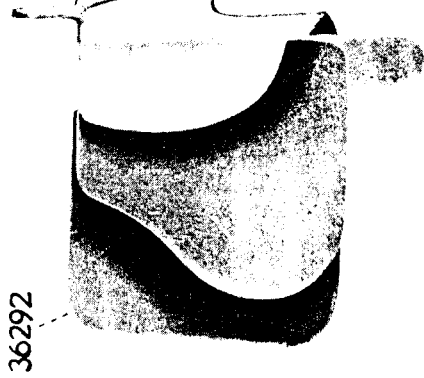


PLATE 5811—FULL SIZE

36521



36712

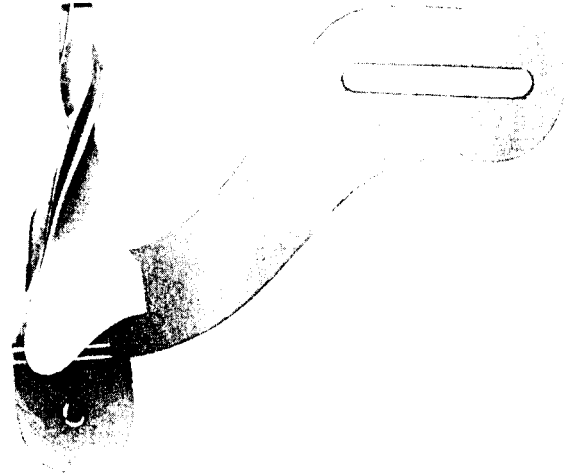


PLATE 5812—FULL SIZE

36129

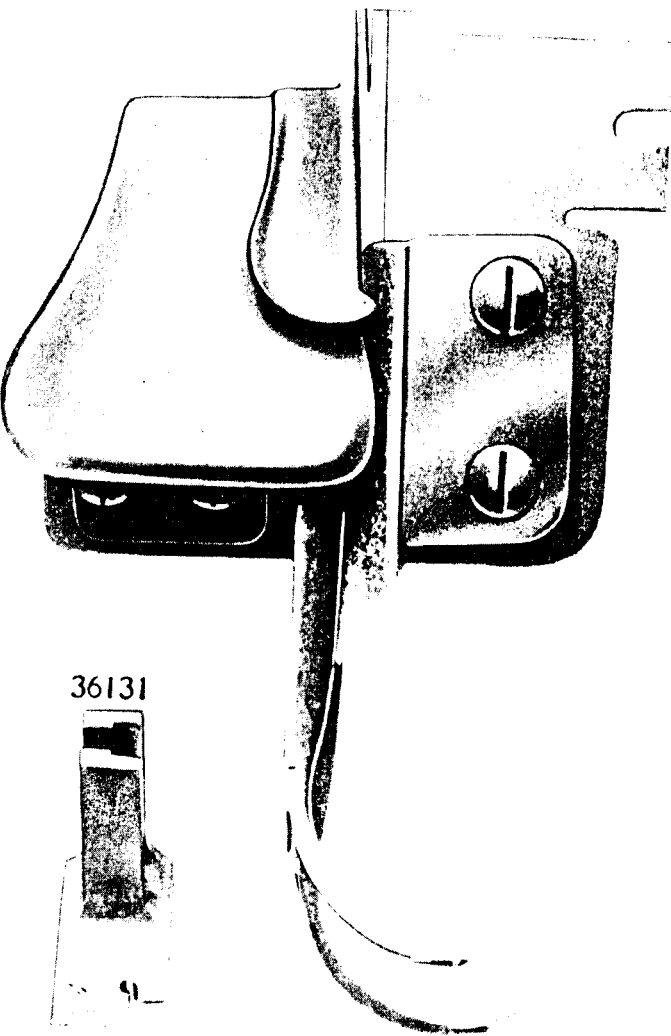
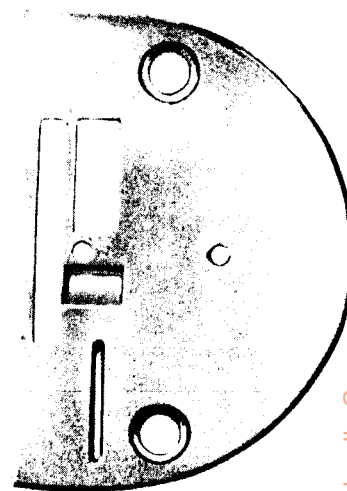


PLATE 5813—FULL SIZE

19474



36906



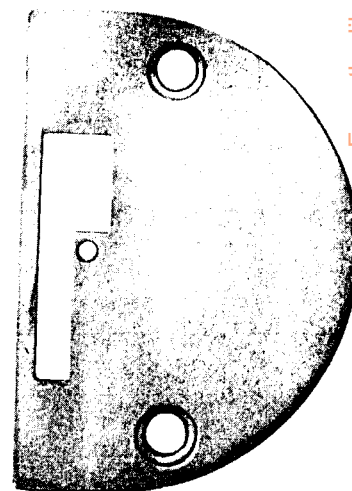
44252



44253



44255



44254



PLATE 5839—FULL SIZE

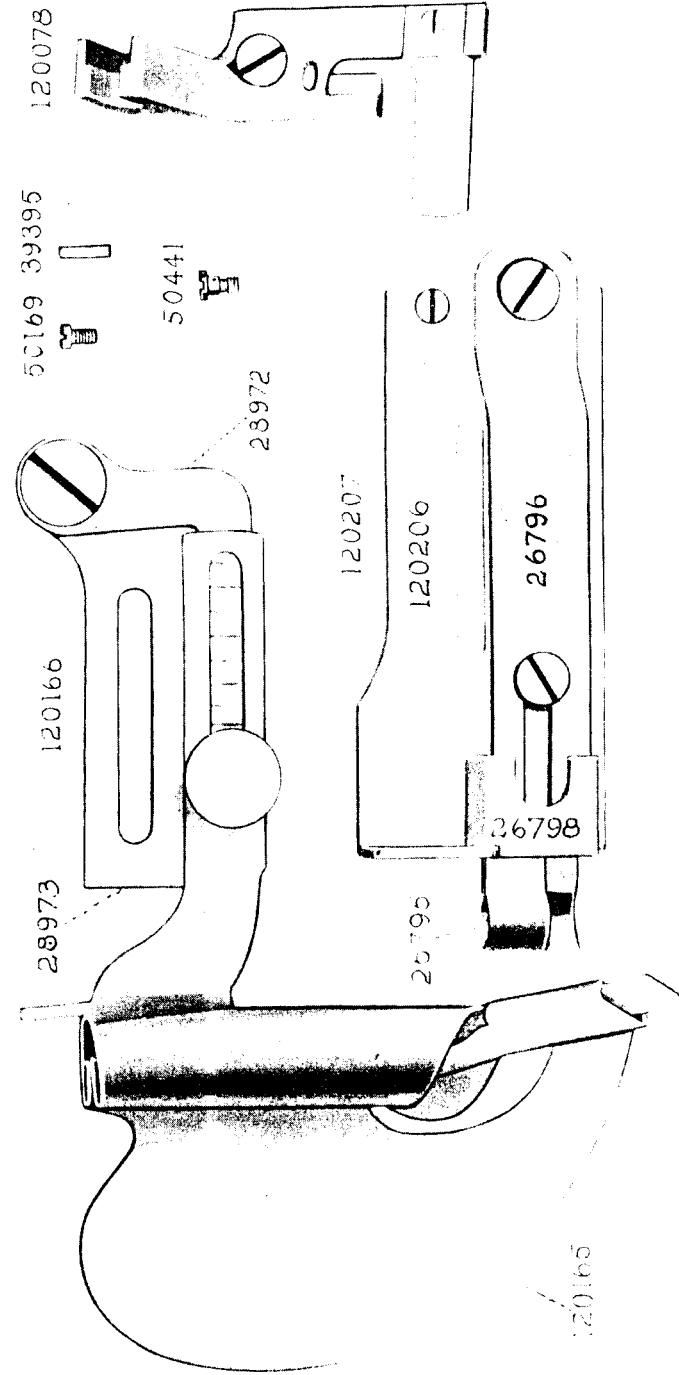
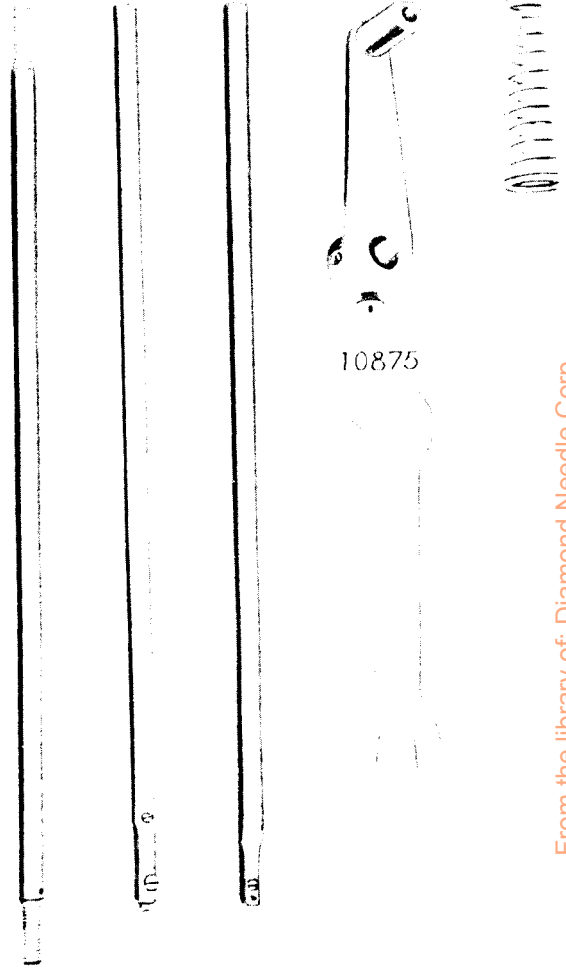


PLATE 5841—ONE-HALF SIZE

46659 16568 19265 24431 27638



10875

From the library of: Diamond Needle Corp

PLATE 5842—FULL SIZE

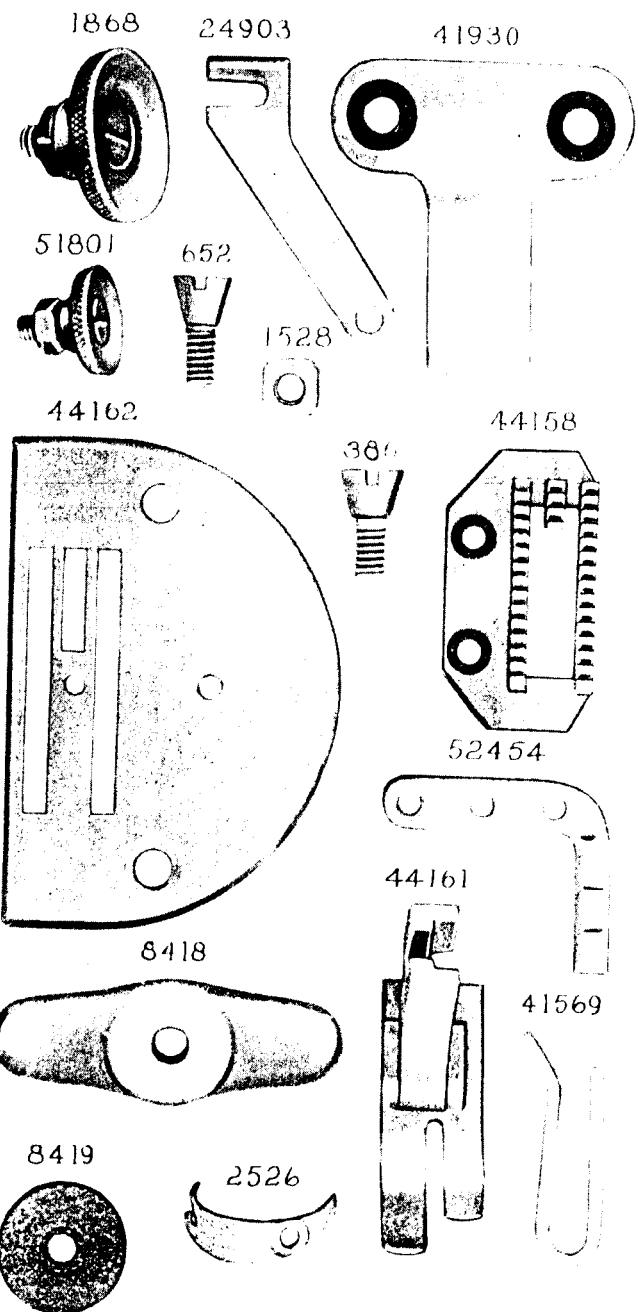
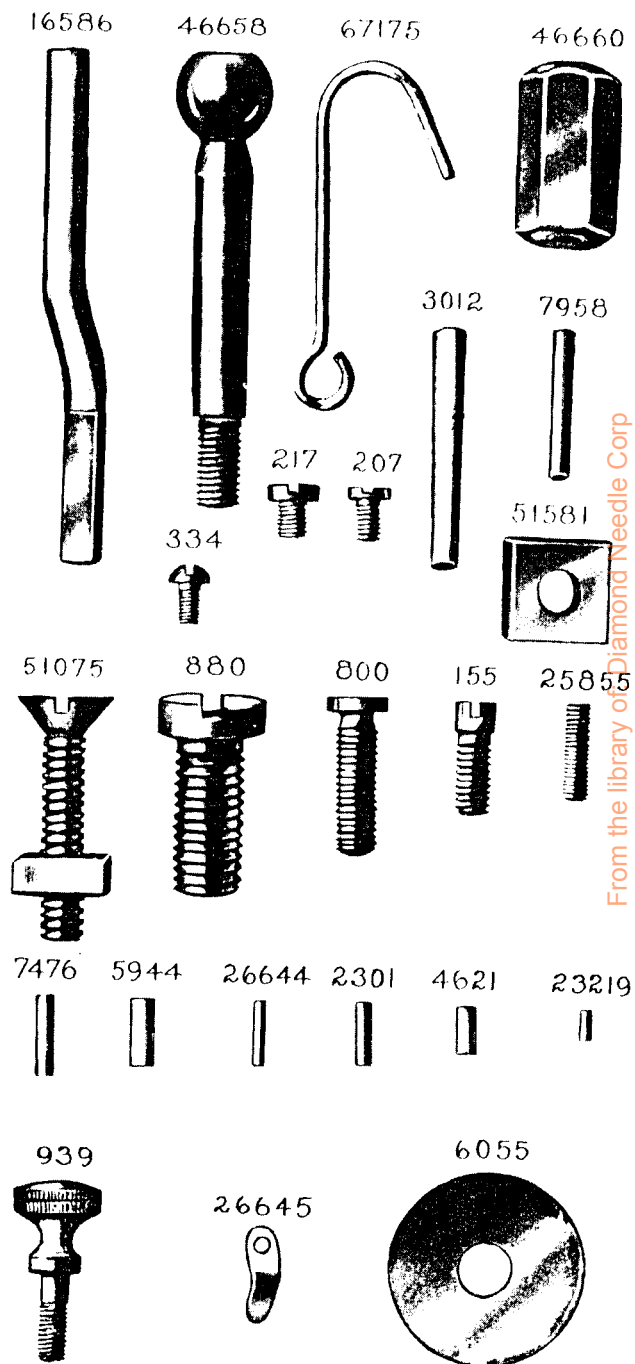


PLATE 5843—FULL SIZE



From the library of Diamond Needle Corp

PLATE 5845—ONE-HALF SIZE

120191

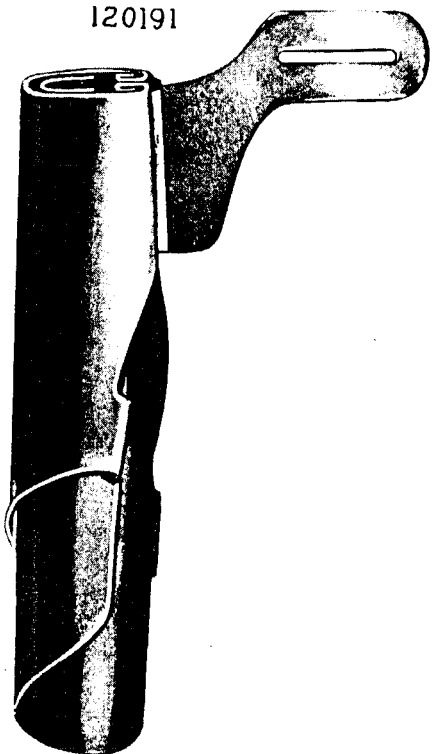
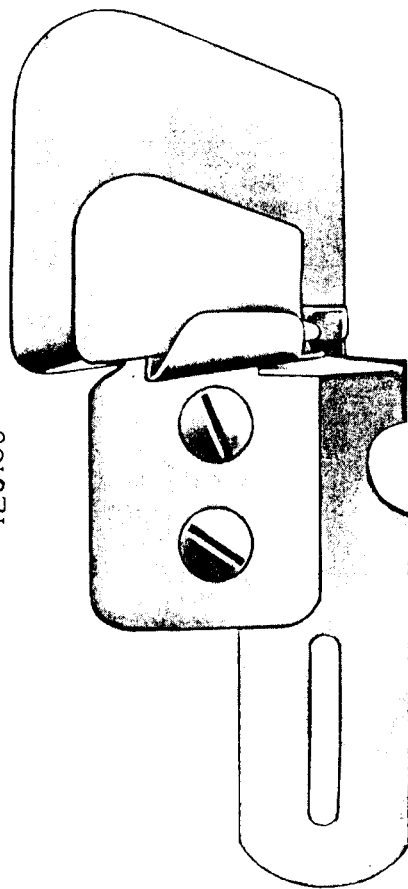


PLATE 5846—FULL SIZE

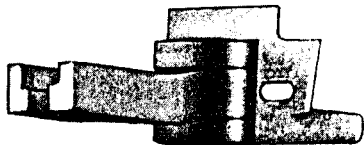
120136



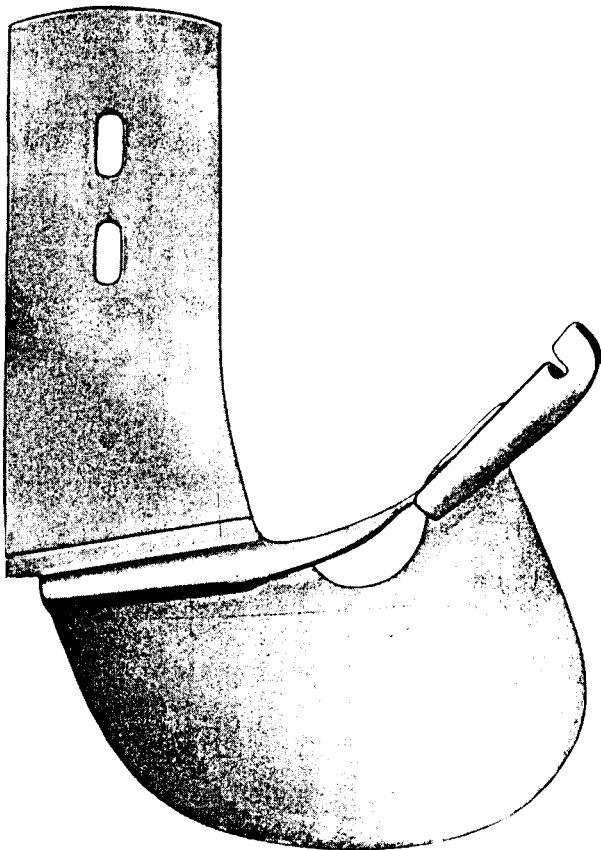
120135



120144



120257



120197

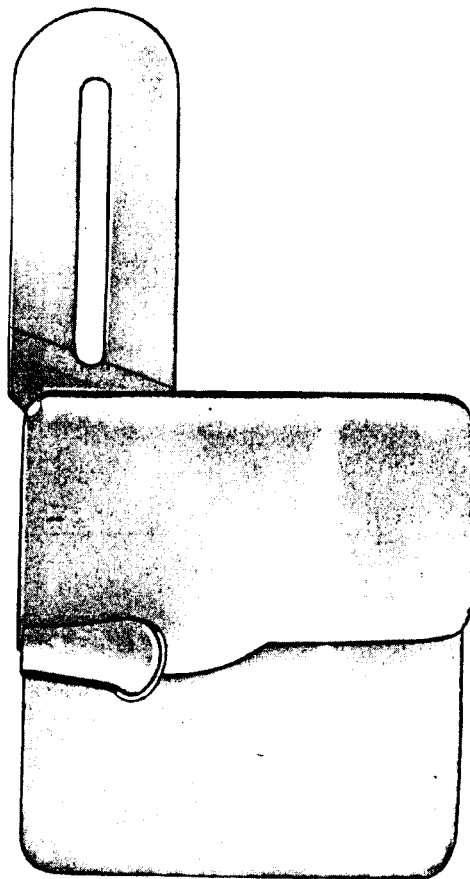


PLATE 6119—ONE-HALF SIZE

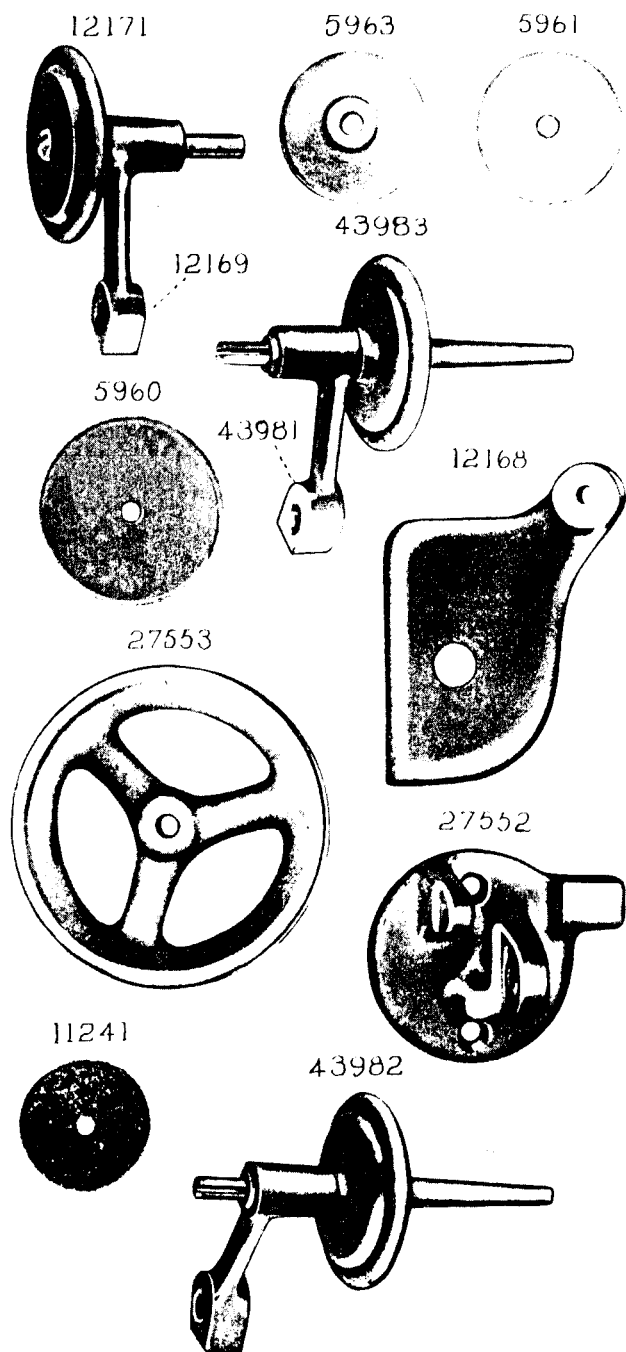


PLATE 6142—ONE-EIGHTH SIZE

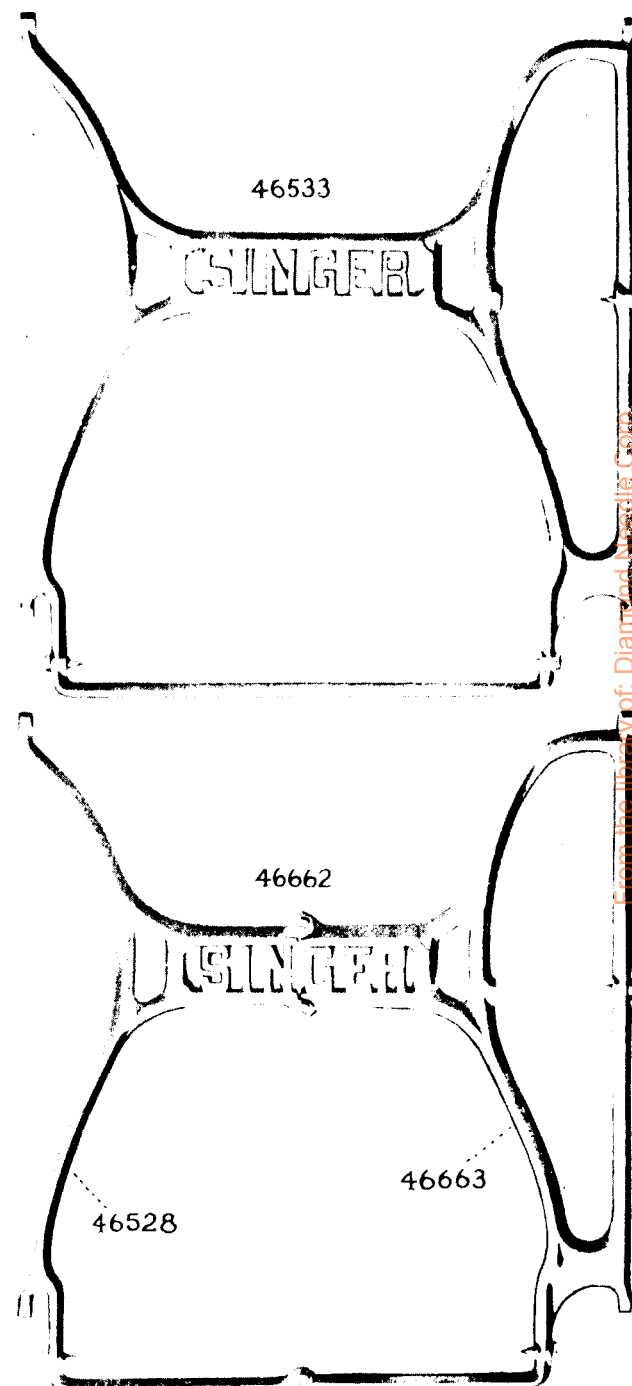


PLATE 6252—FULL SIZE

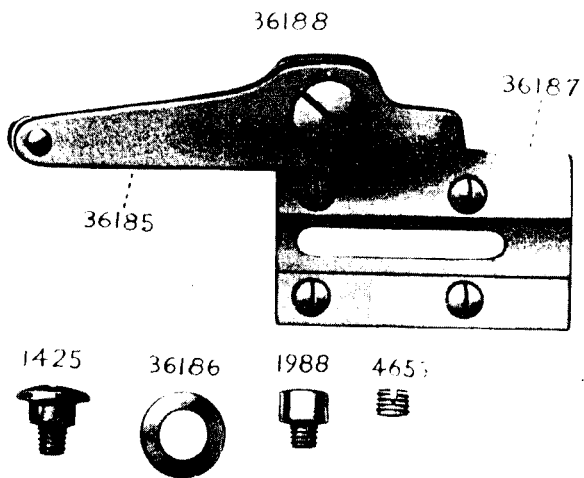


PLATE 6254—FULL SIZE

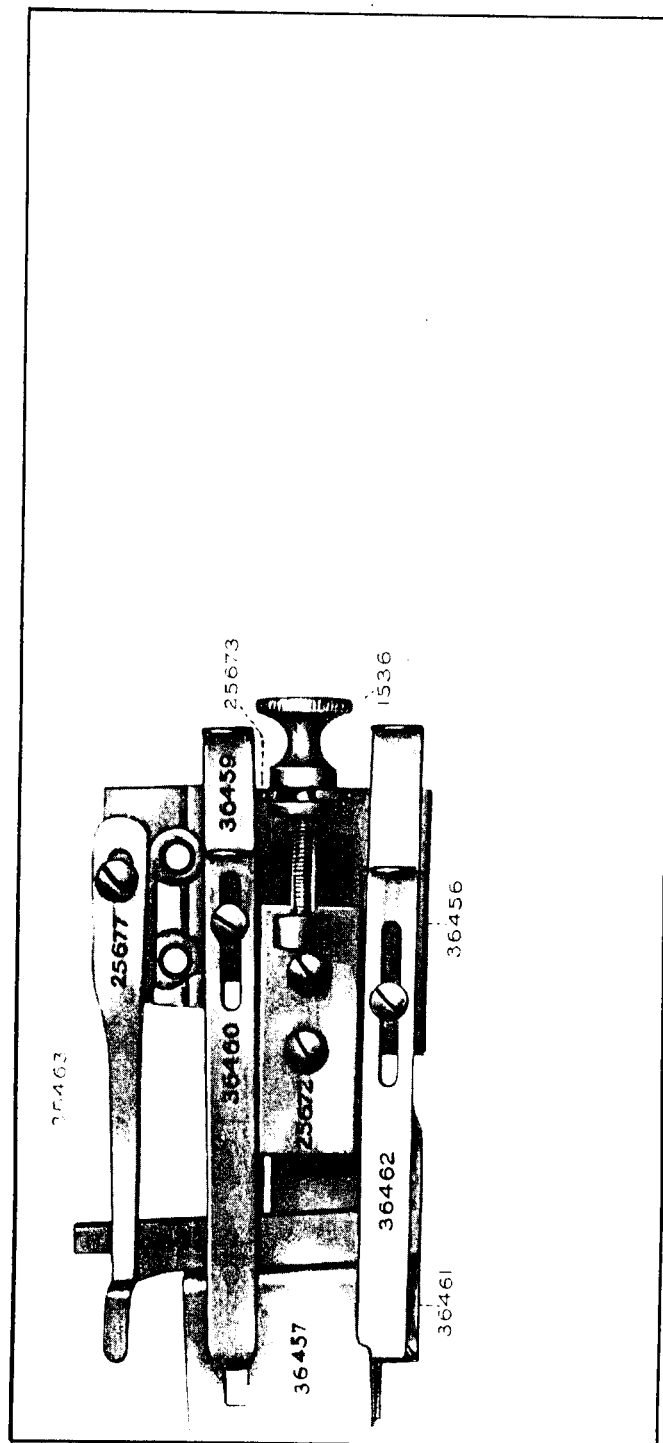
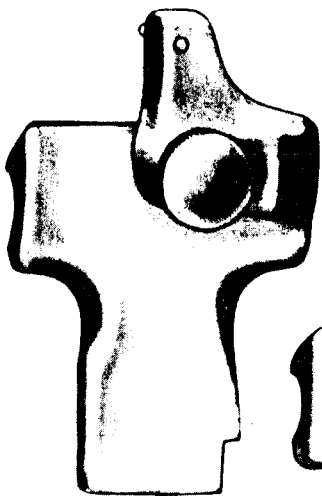


PLATE 6255—FULL SIZE

27681



11833 27660



27682

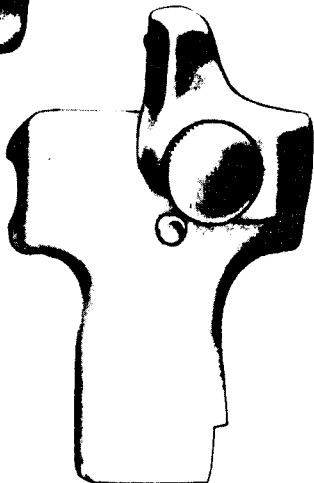
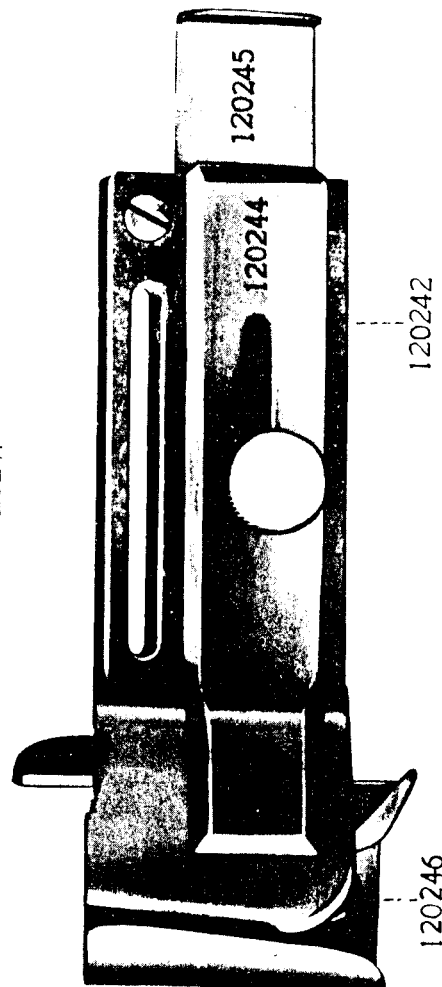


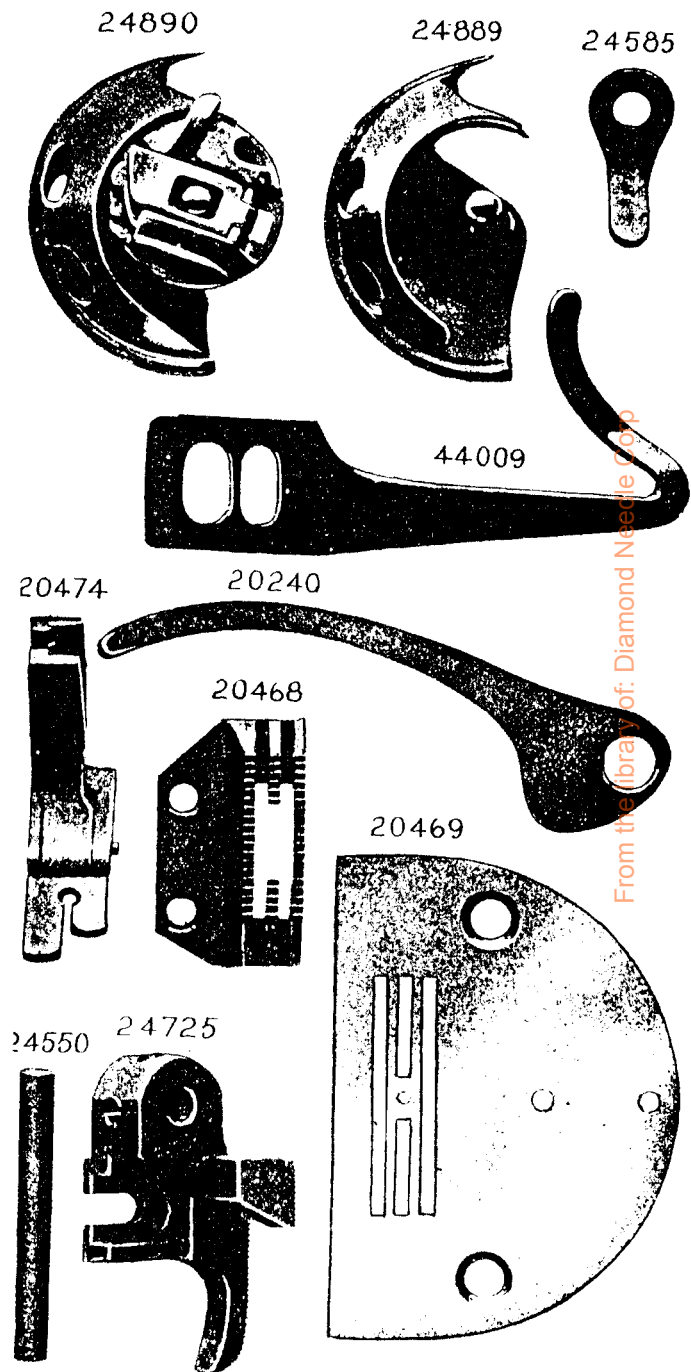
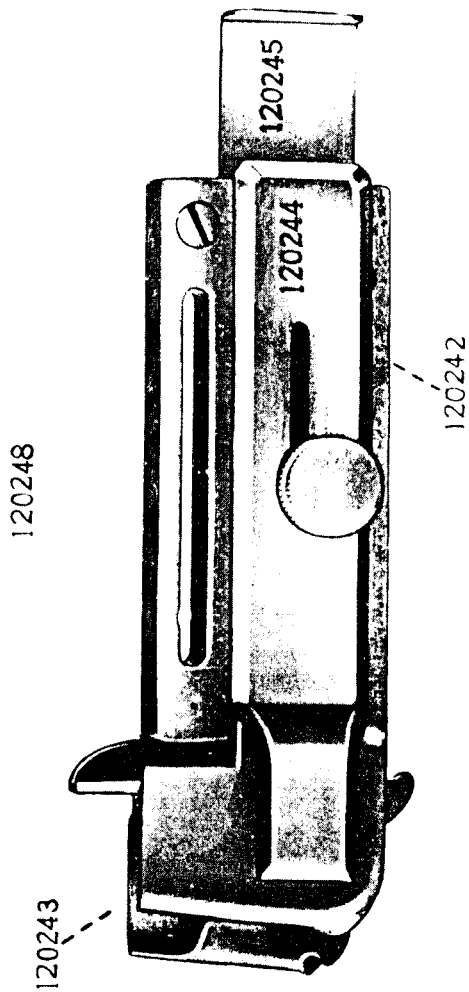
PLATE 7790—FULL SIZE

1036



120247





From the library of: Diamond Needle Corp

PLATE 8376—FULL SIZE

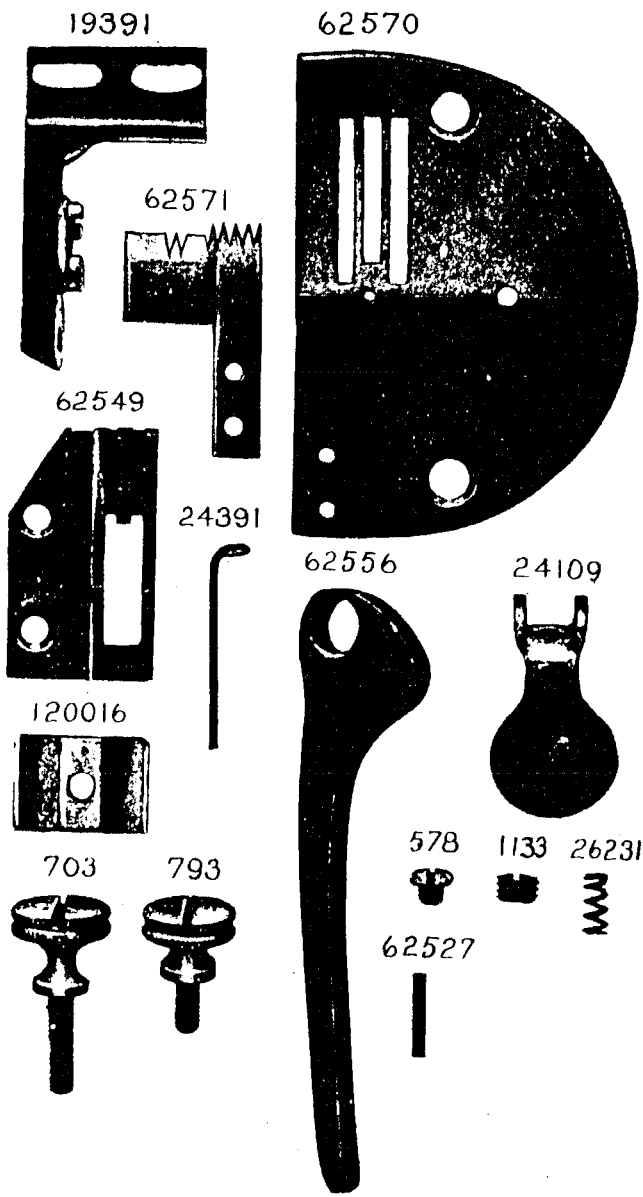
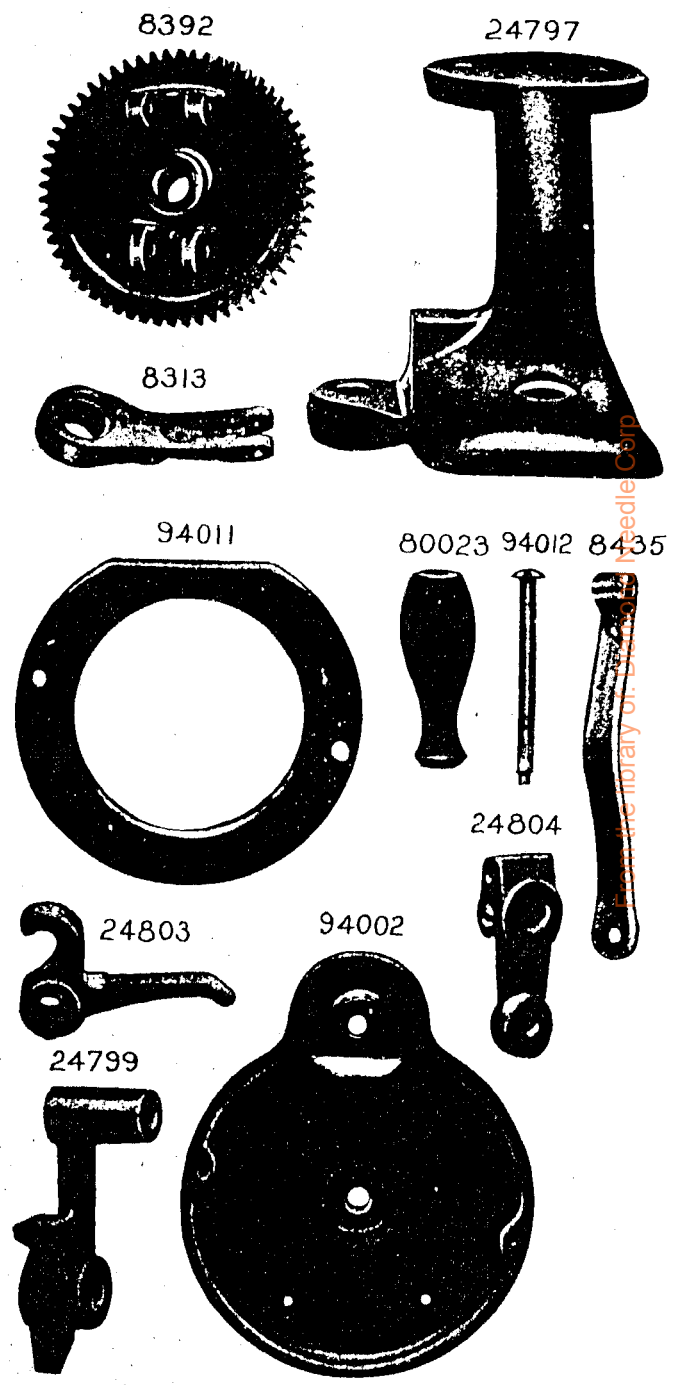


PLATE 8377—ONE-HALF SIZE



© 1964 by the Library of Congress, Inc. Needle Corp.

PLATE 8378—FULL SIZE

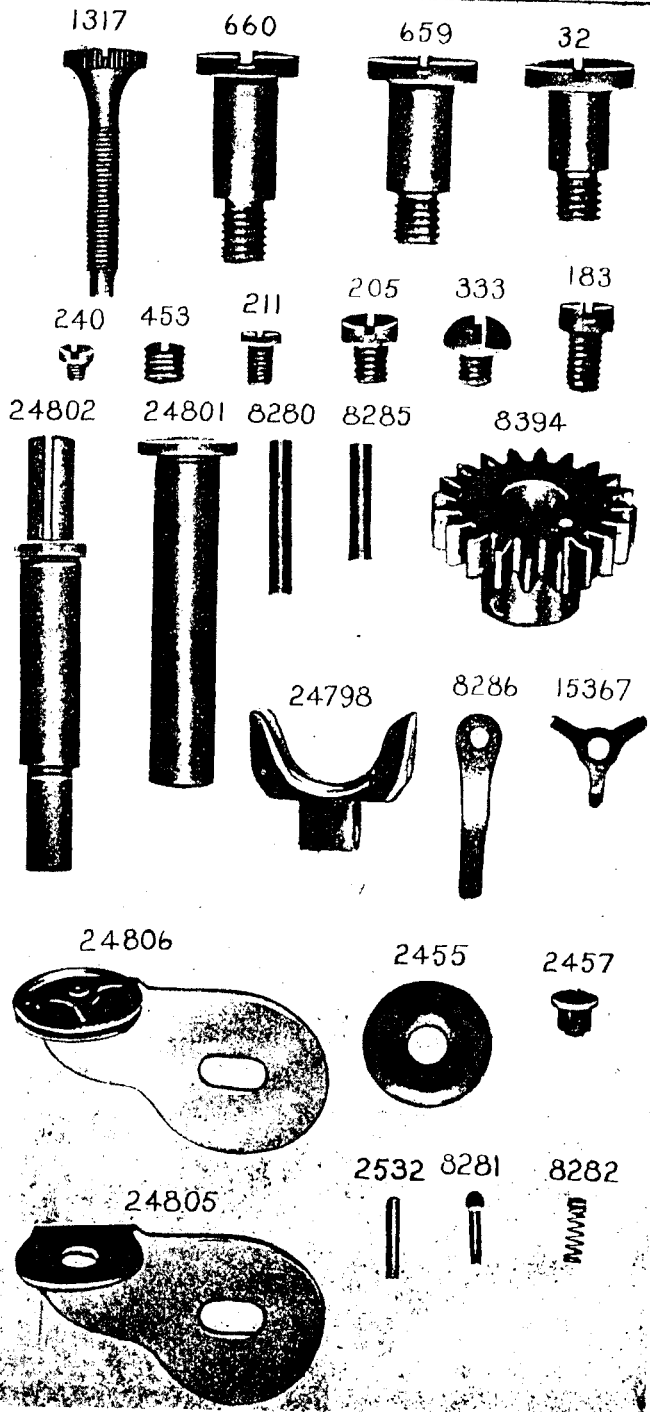
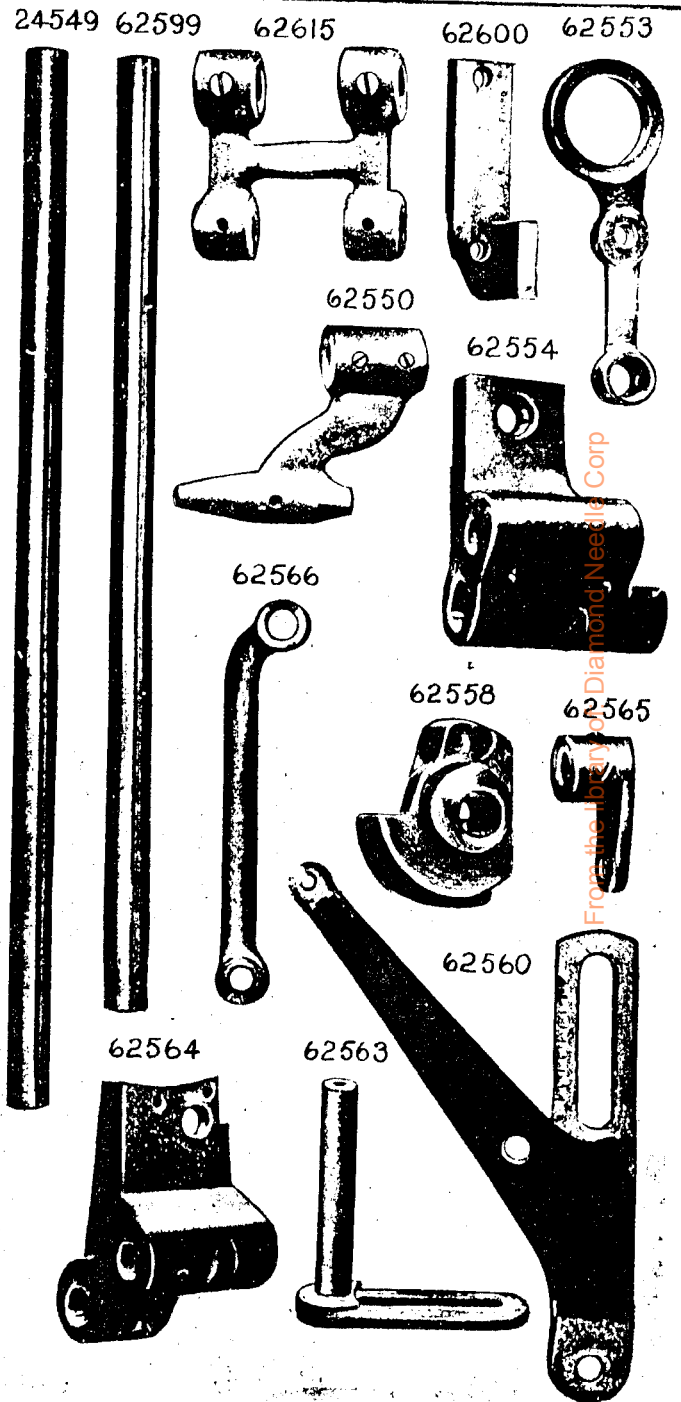


PLATE 8379—ONE-HALF SIZE



From the Library of Diamond Needle Corp

PLATE 8380—FULL SIZE

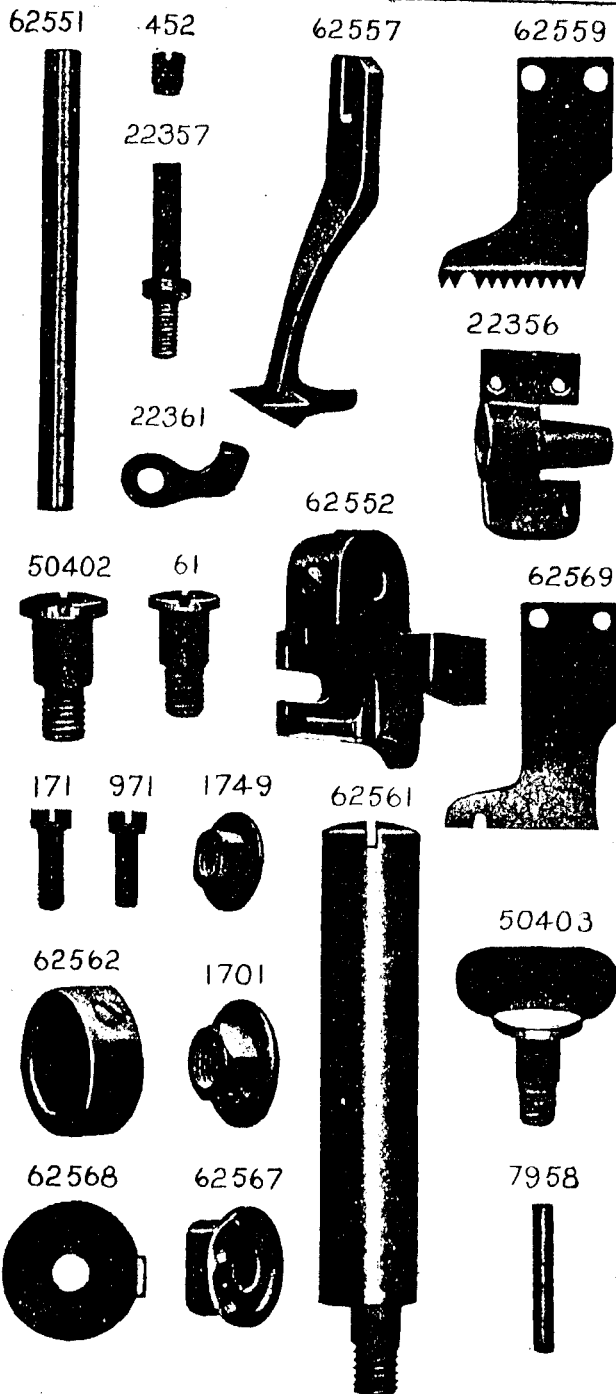
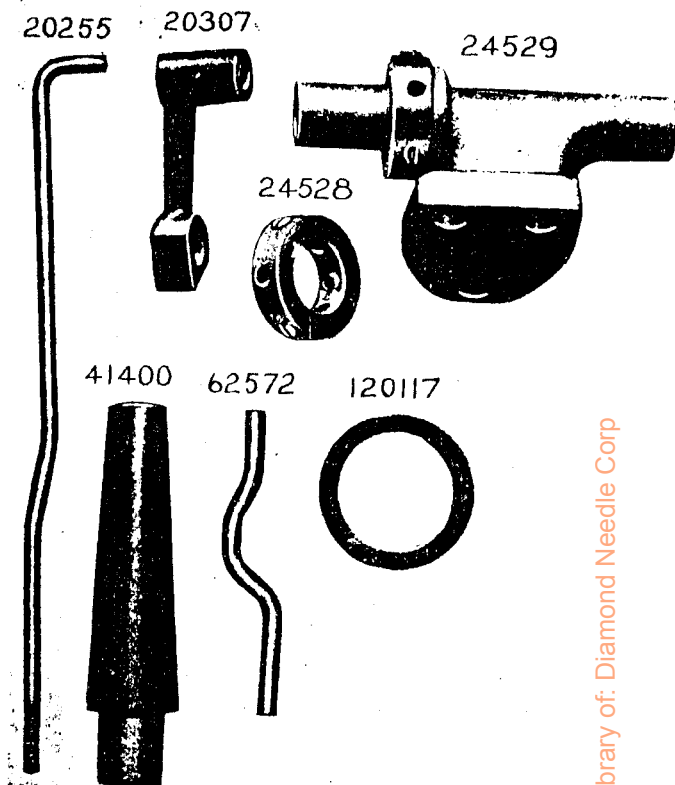
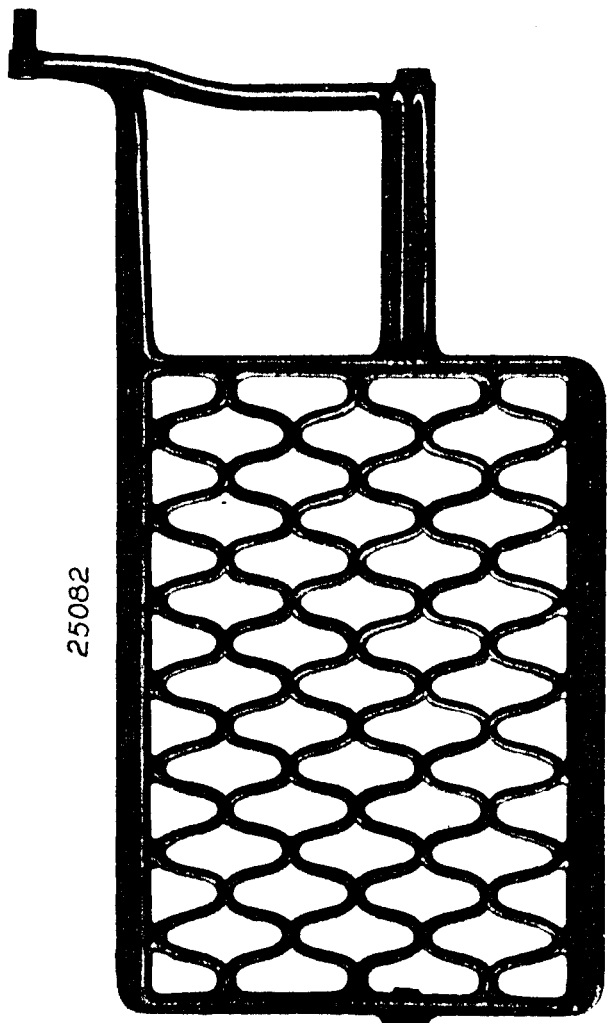
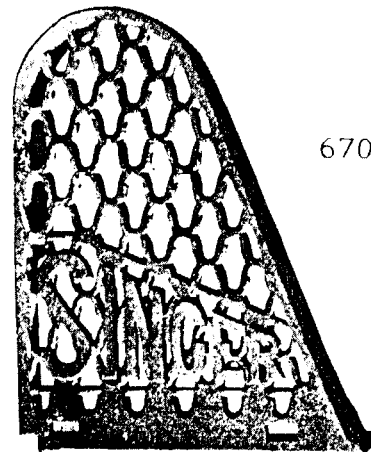


PLATE 8381—ONE-HALF SIZE





41929



67177



24908

